

MAT 498: Glass in energy

Objectives

- ❑ To provide an overview of the use of **glass in** the field of **energy**, starting with a general introduction to glass, followed by a review of specific domains where glass is used in energy at present, or is emerging as an alternative for the near future.
- ❑ Lecture 1 (1/17): Glass basics I
- ❑ Lecture 2 (1/19): Glass basics II
- ❑ Lecture 3 (1/24): Energy efficiency in glass manufacture
- ❑ Lecture 4 (1/26): Glasses for solar energy I – low-E and solar control glass
- ❑ Lecture 5 (1/31): Glasses for solar energy II – solar thermal energy
- ❑ Lecture 6 (2/2): Glasses for solar energy III – PV and photochemical
- ❑ Lecture 7 (2/7): Glass fibers for wind energy
- ❑ Lecture 8 (2/9): Glasses for nuclear waste vitrification
- ❑ Lecture 9 (2/14): Glasses for fuel cells and H₂ storage
- ❑ Lecture 10 (2/16): Glasses for Li batteries and super-capacitors I (Prof. S. Martin)
- ❑ Lecture 11 (2/21): Glasses for Li batteries and super-capacitors II (“ ”)
- ❑ Lecture 12 (2/23): Laser glass
- ❑ Lecture 13 (2/28): Glasses for white light generation
- ❑ Lecture 14 (3/1): Exam

Glass in energy

Glass basics I

MAT 498

Lehigh University

Glass
and
glass fabrication

Glass and amorphous materials

What is glass?

A **glass**, whether in *bulk, fiber or film* form, is a **non-crystalline solid (NCS)**. In principle, any substance can be vitrified by **quenching** it **from the liquid state**, while preventing crystallization, into a solid glass. A glass is, therefore, a non-crystalline (or amorphous) solid.

Most commercially available glasses, are prepared by melting and quenching. But **deposition from a vapor** or a **liquid solution** are alternative methods to obtain glasses, usually in thin film form, some of which may otherwise be rather difficult to prepare from the melt.

Glass formation, although in principle a property of any material, is in practice limited to a relatively **small number of substances**. And **most commercial glasses** available in large bulk shapes are **silicates** of one type or another, i.e., materials based on silica, the oxide **SiO₂**.

The structural transformation of silica from crystal to glass

(2-D representation; in 3-D, the CN_{Si} is 4)

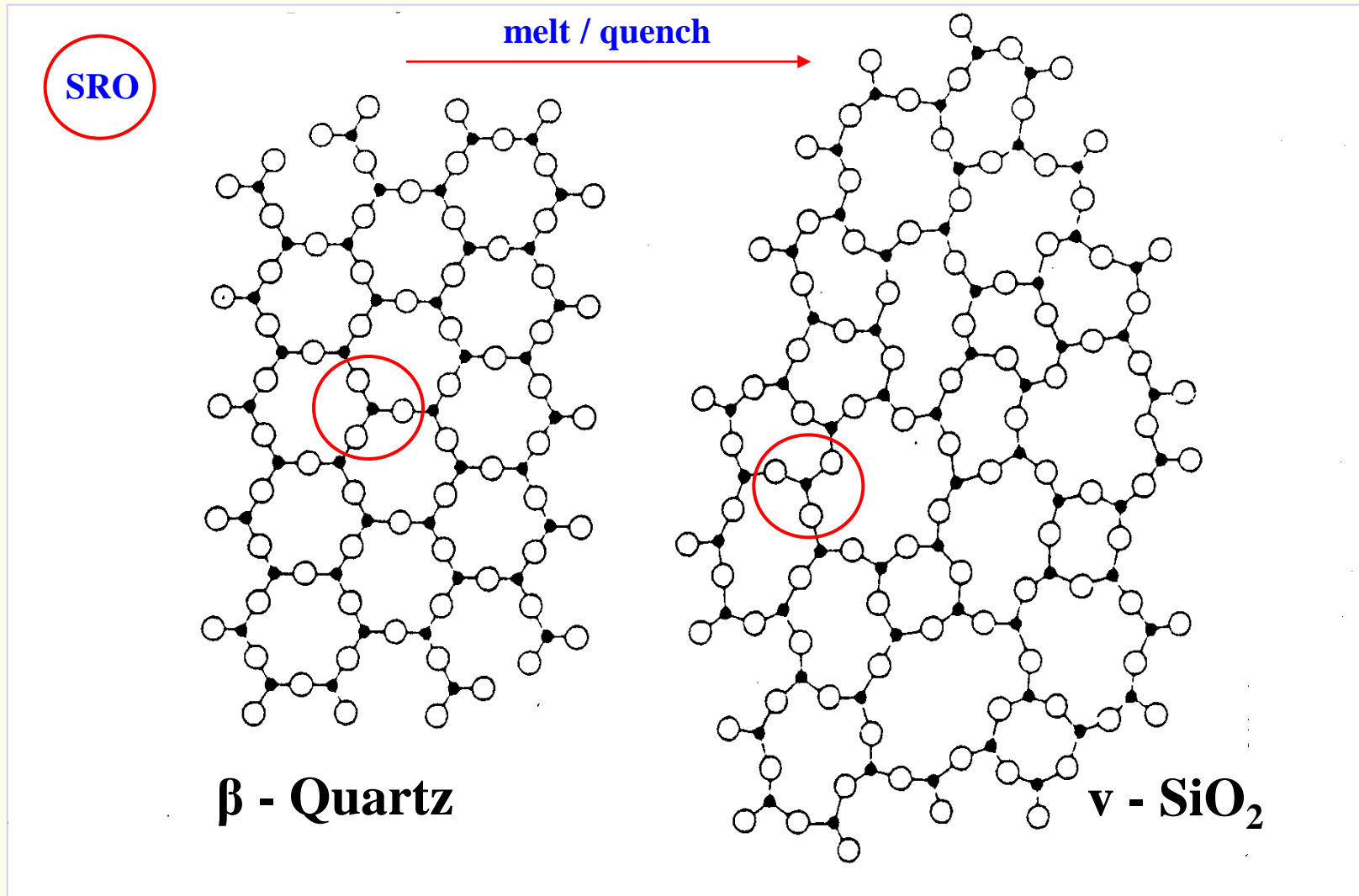

Quartz crystal

Silica glass

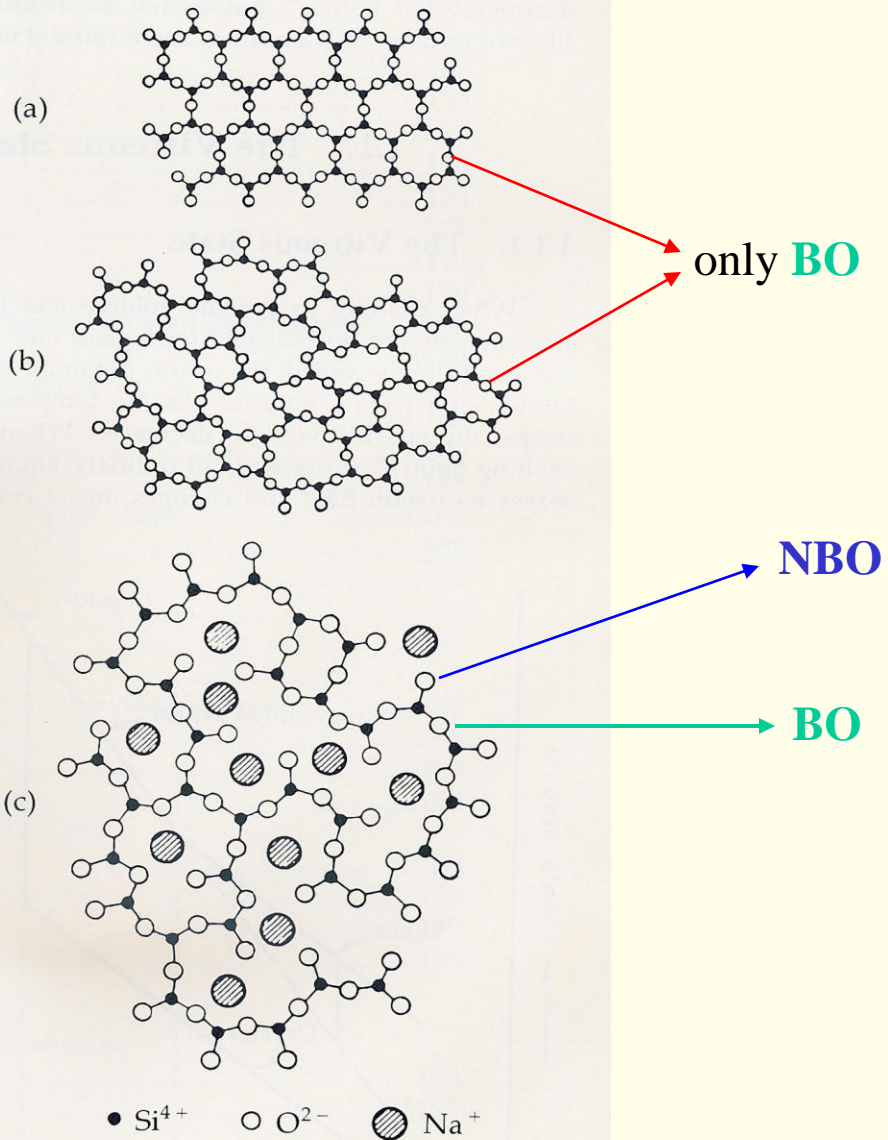

Figure (c) depicts the structure of a $\text{SiO}_2\text{-Na}_2\text{O}$ glass, where **BO** and **NBO** species can be identified.

Network structure of SiO_4^{4+} tetrahedrons: (a) quartz crystal, (b) quartz glass, (c) sodium silicate glass (Ref. 5).

(Adapted from: *Optical glass*, T.S. Izumitani, Hoya Corporation, 1986)

Glass formation

Below are some of the most representative **glass-forming substances** known to date.

TABLE 6.5-1 Glass-forming systems.

Elements:	S, Se, P
Oxides:	B_2O_3 , SiO_2 , GeO_2 , P_2O_5 , As_2O_5 , Sb_2O_3 , In_2O_3 , SnO_2 , PbO_3 , and SeO_2 , TeO_2
Halides:	BeF_2 , AlF_3 , $ZnCl_2$, $Ag(Cl, Br, I)$, $Pb(Cl_2, Br_2, I_2)$, and multicomponent mixtures
Sulfides:	As_2S_3 , Sb_2S_3 , CS_2 , and various compounds of B, Ga, In, Te, Ge, Sn, N, P, and Bi
Selenides:	Various compounds of Tl, Sn, Pb, As, Sb, Bi, Si, and P
Tellurides:	Various compounds of Tl, Sn, Pb, As, Sb, Bi, and Ge
Nitrides:	KNO_3 - $Ca(NO_3)_2$ and many other binary mixtures containing alkali and alkaline earth nitrates
Sulfates:	$KHSO_4$ and other binary and ternary mixtures
Carbonates:	K_2CO_3 - $MgCO_3$
Polymers:	Polystyrene, polymethylmethacrylate, polycarbonate, polyethylene terephthalate, and nylon
Metallic alloys:	Au_4Si , Pd_4Si , (Fe-Si-B) alloys

Source: Robert H. Doremus, *Glass Science*, 1st ed., Copyright © 1973 by John Wiley & Sons. Reprinted by permission of John Wiley & Sons, Inc.

(Adapted from: *The science and design of engineering materials*. J.P. Schaffer et al., McGraw-Hill, 1999)

Glass transition temperature

Most commercially available glasses are NCS obtained by rapid solidification of a viscous liquid below a given “freezing” temperature, designated by Glass Transition Temperature, T_g . (We shall see that T_g is often $\sim 2/3$ of the melting (or the liquidus) temperature, T_m).

The liquid of rapidly increasing viscosity which is obtained between T_m and T_g is called a *supercooled liquid*. T_g marks, therefore, the transformation from the **supercooled liquid into the solid glass, at which the viscosity is 10^{12} Pa.s.**

The preparation of glasses by melting and quenching may be understood by **plotting the volume** (or the enthalpy), or their corresponding derivatives, the thermal expansion coefficient, α_T (or the specific heat, c_p), **as functions of temperature.**

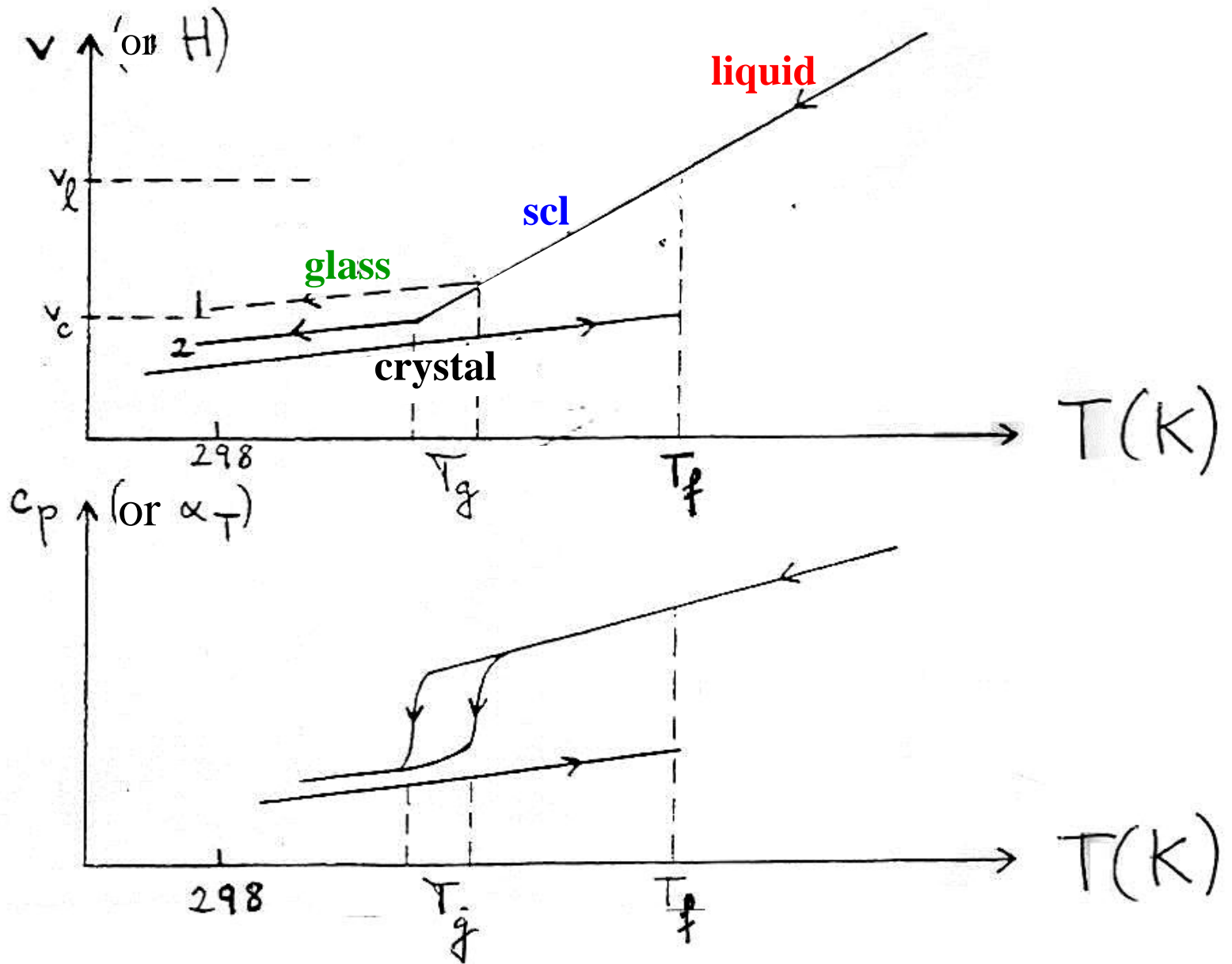

The glass is in a higher energy state, compared to the corresponding crystal.

This can be considered a metastable state, in the sense that a certain **thermodynamic energy barrier** exists (related to the activation energy for crystal growth) for the glass to crystallize. Such energy is provided when the glass is heated above its temperature of onset of crystallization (obtainable from a DSC, or DTA, run).

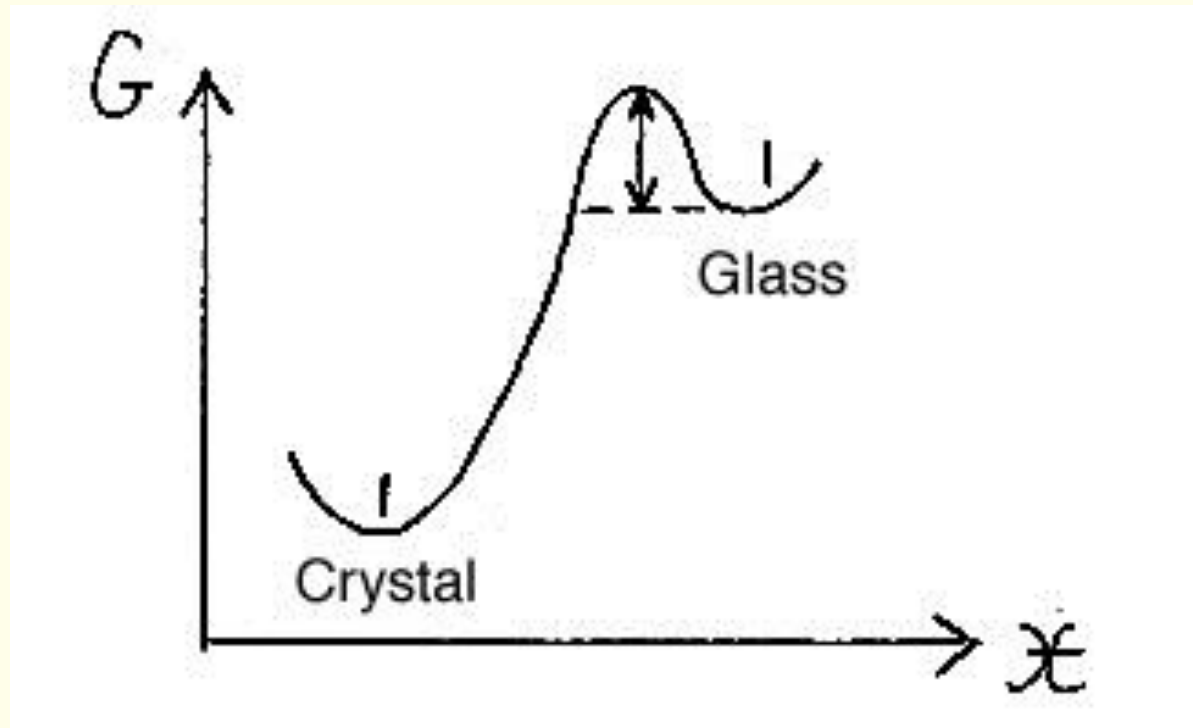

The value of T_g for a given glass can be obtained, for example, from a measurement of its thermal expansion coefficient, as we shall see later.

T_g can also be routinely measured by means of DSC (or DTA) scans, which also provide the temperature of onset of glass crystallization, T_x , as well as estimates of the solidus and liquidus temperatures of the system (which may vary with the scan rate).

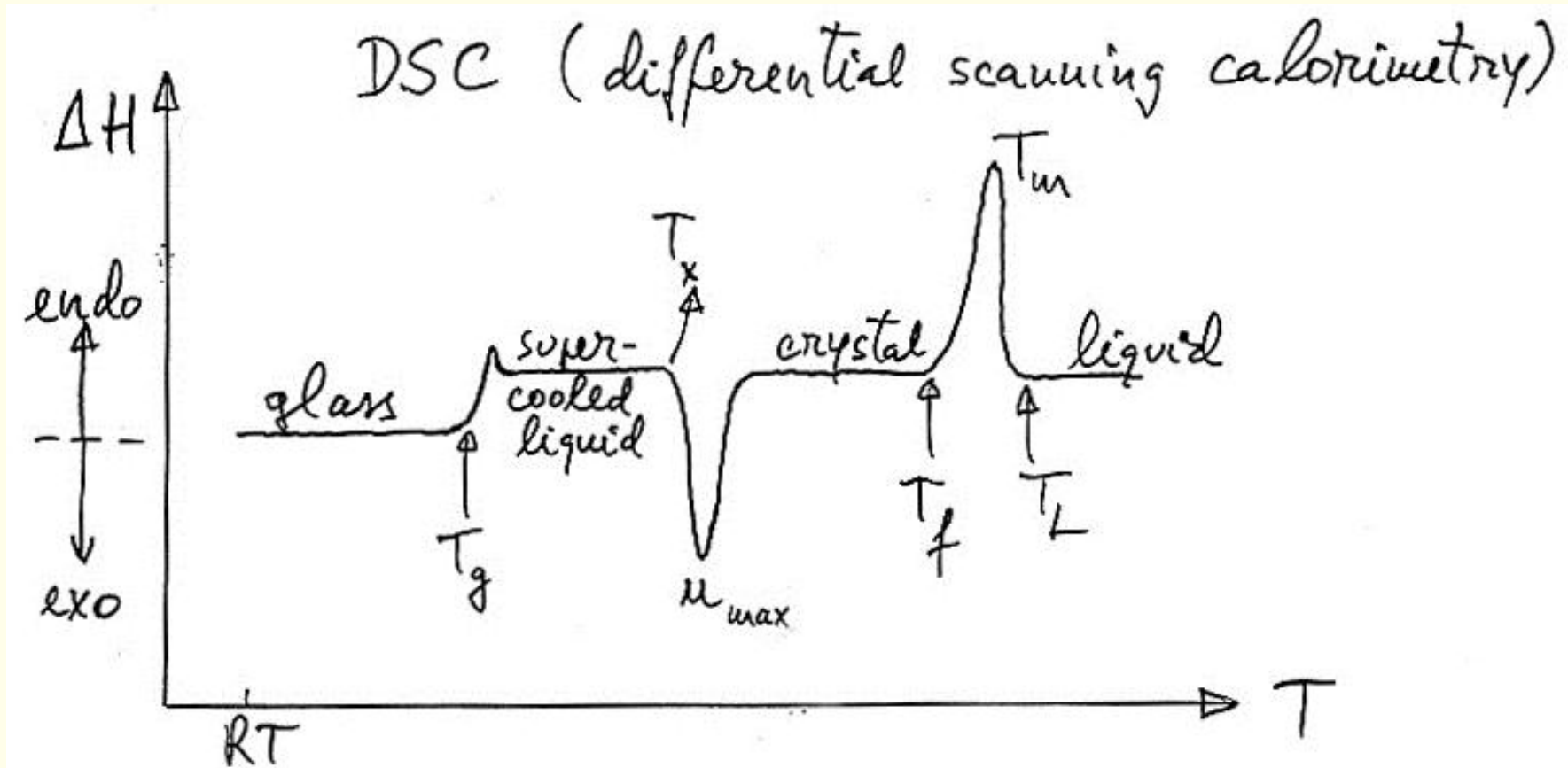

Sakka and Mackenzie (1971) have established the so-called “two thirds” rule, which expresses the fact that, for most **good glass-forming substances** (or **systems**), the ratio between T_g and the melting (or liquidus) temperatures is of the order of “two thirds”:

$$T_g / T_m \sim 2/3$$

when the temperatures are expressed in Kelvin.

(For **poor glass-forming systems**, this ratio is often **close to 0.60 or 0.70**, rather than 0.66).

Glass ceramics

A further example is a rather useful class of composite materials (which are sometimes nanocomposites) known as **glass-ceramics** (GC). These are polycrystalline solids, obtained through the *controlled nucleation and growth of a crystalline phase* (often rather fine grained) within a starting glass matrix. A **residual amorphous phase** is always present, normally in a volume fraction between ~5–45 %.

The controlled nucleation is normally achieved through the addition of a small amount of a *nucleating agent* (e.g. TiO_2 , ZrO_2 or P_2O_5) which leads to a very **fine grained ceramic** with an average grain size usually $< 1 \mu\text{m}$. This leads to a highly mechanically resistant ceramic **without** any **porosity** and prepared in **any** desired **shape** by the initial **glass casting**.

Other highly desirable properties of GC are a **low thermal expansion** and **good chemical durability**, which prompts their use as stove tops and dinnerware. **Optical** applications include **transparent** GC for high performance light bulbs and space mirror blanks. The *tailoring of the GC microstructure* is a key aspect of this important technology.

The basic processing of GC materials starts with melting of the glass at a temperature $T_m > T_L$, followed by cooling to a temperature T_n , where the rate of *nucleation* (essentially *heterogeneous*, in this case) is maximum (or by cooling to room T and reheating to T_n). The nucleation stage is then followed by a shorter *growth step* at the temperature T_{gr} , of maximum crystal growth rate (u_{max}) and finally by cooling to RT.

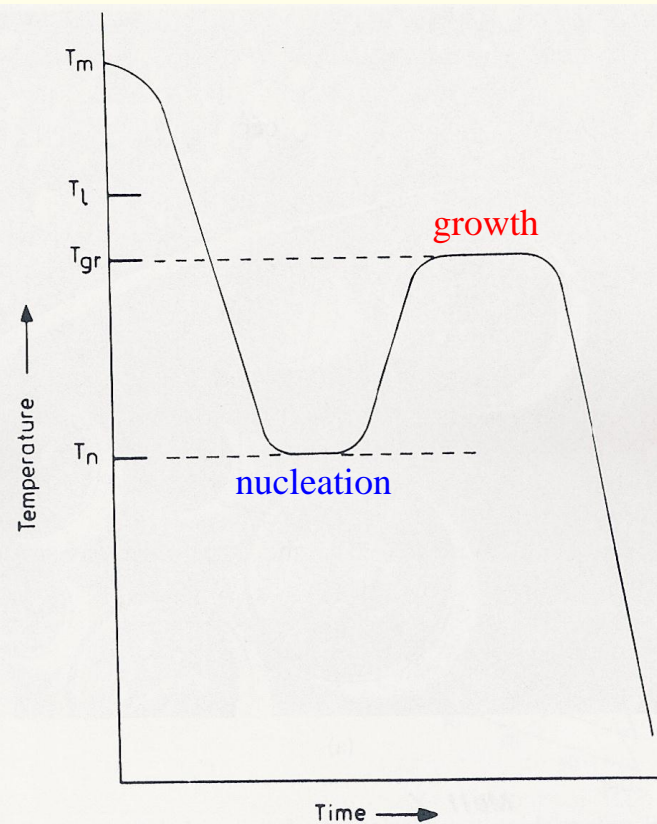

A typical heat treatment schedule for the glass-ceramic process. T_m = the melting temperature; T_l = the liquidus temperature; T_n = temperature corresponding to maximum nucleation rate; T_{gr} = maximum crystal growth rate temperature.

(Adapted from: *Fundamentals of inorganic glasses*, A.K. Varshneya, Academic Press, 1994).

Glass composition and preparation

Commercial glass compositions are based on complex mixtures of *glass-forming* compounds, *glass modifiers* and *intermediates*, in the Zachariasen/Sun sense. (See: [theories of glass formation](#)).

Although most industrial glasses are based on the **glass former SiO_2** , many other compounds are normally added, whether also glass formers like **B_2O_3** , or other **modifiers** and **intermediates**.

We will start by considering **the most important case**, from an industrial viewpoint, of **glasses prepared by cooling from the molten state**.

Abundance of chemical elements in earth crust (on a mol% basis):

O - 50 %

Si - 25 %

Al - 7 %

Fe - 4 %

Ca - 3 %

Na - 2.5 %

K - 2 %

Mg - 2 %

95.5 %

Most abundant minerals:

silicates

alumino-silicates

other oxides

Typical oxide glass compositions (in weight %)

window: 72 SiO₂-1 Al₂O₃-10 CaO-2.6 MgO-13.6 Na₂O (soda-lime glass)

container: 72 SiO₂-2 Al₂O₃-10 CaO-0.8 K₂O-13.7 Na₂O ...

borosilicate: 80 SiO₂-12 B₂O₃-2 Al₂O₃-5 Na₂O ... (“pyrex glass”,...)

fiber: 54 SiO₂-10 B₂O₃-14 Al₂O₃-17.5 CaO-4.5 MgO

optical: 46 SiO₂-45 PbO-7 K₂O-1.7 Na₂O ...

Typical compositions of commercial glasses (wt %)

Glass	SiO ₂	Al ₂ O ₃	Fe ₂ O ₃	CaO	MgO	BaO	Na ₂ O	K ₂ O	SO ₃	F ₂	PbO	B ₂ O ₃	ZnO	TiO ₂	Cr ₂ O ₃	As ₂ O ₅	CeO ₂
Flint container	72.6	1.6	0.05	11.0	0.1	—	13.7	0.5	0.2	—	—	—	—	0.1	—	—	—
Amber container	72.7	1.9	0.22	10.0	—	—	13.8	1.0	0.03	—	—	—	—	—	—	—	—
Green container	72.0	1.1	0.96	8.4	2.1	—	15.1	—	—	—	—	—	—	—	0.19	—	—
Flat	72.8	1.4	0.1	8.2	3.8	—	12.8	0.8	0.3	—	—	—	—	—	—	—	—
Borosilicate	80.2	2.6	0.07	0.1	—	—	4.5	0.3	—	—	—	12.3	—	—	—	—	—
Lighting ware (opal)	59.9	6.1	0.05	—	—	1.3	14.9	2.3	—	5.8	—	0.8	2.4	—	—	—	—
Full lead crystal	54.9	0.1	0.02	—	—	—	0.2	12.3	—	—	31.9	0.5	—	—	—	0.5	—
Lead crystal	58.5	—	0.02	—	—	—	1.3	13.1	—	—	25.2	1.5	—	—	—	0.5	—
Glass fibre, "A" glass	72.0	2.5	0.5	9.0	0.9	—	12.5	1.5	—	—	—	0.5	—	0.1	—	—	—
Glass fibre, "E" glass	55.2	14.8	0.3	17.7	4.3	—	0.3	0.2	—	0.3	—	7.3	—	—	—	—	—
Colour TV screen	63.2	3.3	—	1.8	1.1	12.7	9.9	7.5	—	—	—	—	—	—	—	—	0.21
Aluminosilicate	57.0	20.5	0.01	5.5	12.0	—	1.0	—	—	—	—	4.0	—	—	—	—	—
Light barium crown	57.1	0.2	—	0.3	—	26.9	—	13.7	—	—	—	1.8	—	—	—	—	—
Dense barium crown	36.2	3.5	—	0.2	—	44.6	—	0.2	—	—	—	7.7	—	—	—	—	—
Light flint	52.5	0.2	—	0.3	—	—	—	9.5	—	—	37.5	—	—	—	—	—	—
Dense flint	48.0	0.2	—	0.3	—	—	5.2	1.2	—	—	45.1	—	—	—	—	—	—

(Adapted from: Glass-making today, P.J. Doyle, Portcullis press, 1979)

Note: the term *flint* is normally used for glasses which contain significant amounts of PbO, including the so-called lead *crystal* glasses (24-32 wt% PbO) and the optical *flint* glasses, containing even higher amounts of PbO (light flint, with up to ~ 44 wt% PbO and dense flint, with up to ~ 60 wt% PbO); *crown* glasses usually have BaO or La₂O₃.

Types of glass

A) Flat glass (window)

- Horizontal draw (Libbey-Owens, 1905)
- Vertical draw (Fourcault, 1902; Pittsburgh, 1926)
- Float glass (Pilkington, 1965)

B) Hollow glass (container, tubing)

- Blowing
- Drawing (tubing)
- IS machines (Individual Section, 1924; bottles, ...)

C) Fiber glass

C) Glass fiber

- for insulation (sieve-like Pt bushing for short fibers)
- continuous fiber (long fibers drawn from Pt bushing)
- optical fiber (extremely long high silica fibers)

Sol-gel glasses

The colloidal route designated by *sol-gel* is a method for preparing glasses, either in **bulk** or **thin film** form.

The traditional sol-gel process, whose origin dates back to the 19th century, may be exemplified in the case of the **preparation of SiO₂ glass**. This starts with the **hydrolysis and polycondensation** of an alkoxide such as tetraethoxy-silane (TEOS) in an acidic medium:

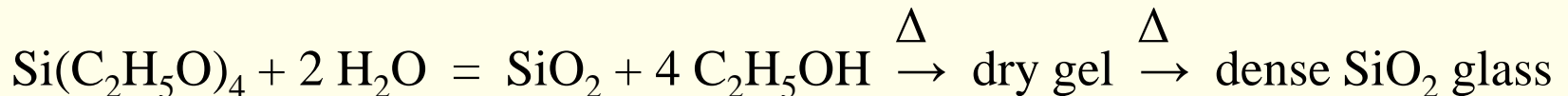

A **colloidal solution** (the “sol”) is first obtained, which polymerizes further (“ageing”) and turns **into a “gel”** (through solvent evaporation); this is further dried and finally densified (at a temperature near T_g) **into a solid, dense glass**.

Glass properties

- density
- mechanical properties

Lecture 2:

- viscosity
- thermal expansion
- annealing and tempering
- optical properties
- transport properties (diffusion, electrical conductivity, chemical durability)

Density and free volume in a glass

There is a **macroscopic** structural parameter, designated by free volume, which is closely related to the macroscopic **density** (ρ), a basic property of the glass. If the molar volumes ($V = M/\rho$) of the glass and corresponding crystal are designated by V_g and V_x , respectively, the corresponding **free volume** is given by:

$$V_f = 1 - V_x/V_g$$

The **free volume** of **v-SiO₂** ($\rho = 2.2 \times 10^3 \text{ kg/m}^3$) with respect to the densest four-coordinated crystalline form of silica, **coesite** ($\rho = 2.9 \times 10^3 \text{ kg/m}^3$), is 0.24 (or 24%), **corresponding to a large fraction of interstitial space**, which is “**free**” for possible **accommodation of modifier ions** such as Na^+ or Ca^{2+} .

However, if the comparison term is α -quartz ($\rho = 2.65 \times 10^3 \text{ kg/m}^3$) rather than coesite, the free volume of v-SiO₂ will only be 17%.

(Adapted from: *Introduction to glass science and technology*, J.E. Shelby, RSC paperbacks, 1997)

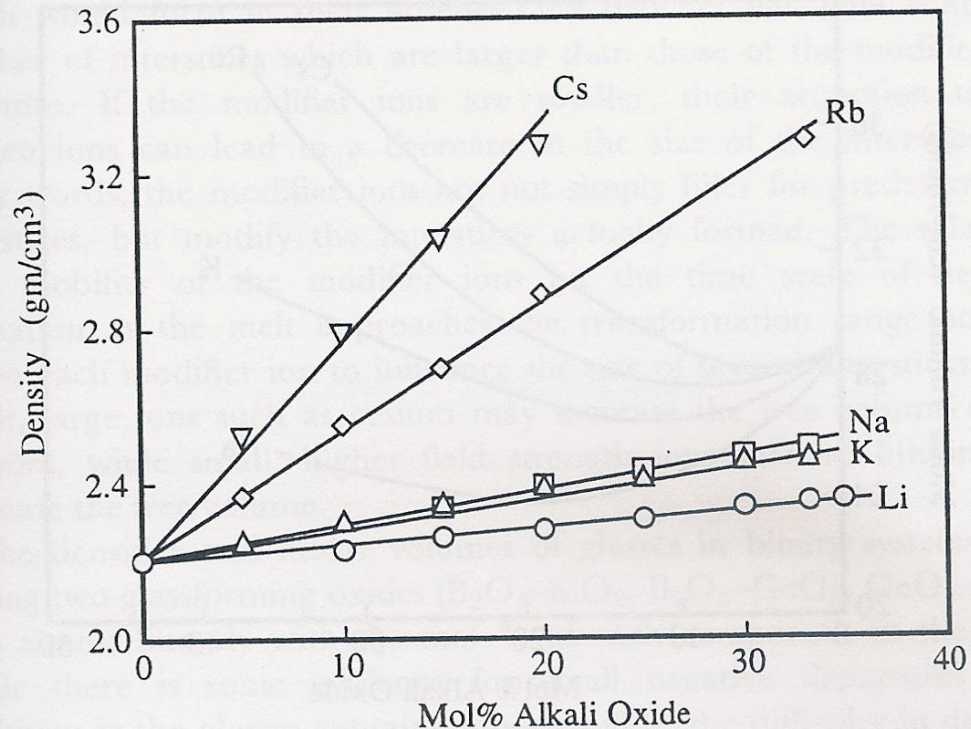

Effect of composition on the density of alkali silicate glasses

The behavior of **glass density is not simple**.

Although the free volume concept would suggest that a significant amount of modifier ions could be added to silica glass, increasing the mass without a volume increase and, therefore, increasing its density, this figure shows that things are not that simple. In fact, the **glasses containing potassium are less dense than those containing sodium**, despite the fact that K is almost twice as heavy as Na.

(Adapted from: *Introduction to glass science and technology*, J.E. Shelby, RSC paperbacks, 1997)

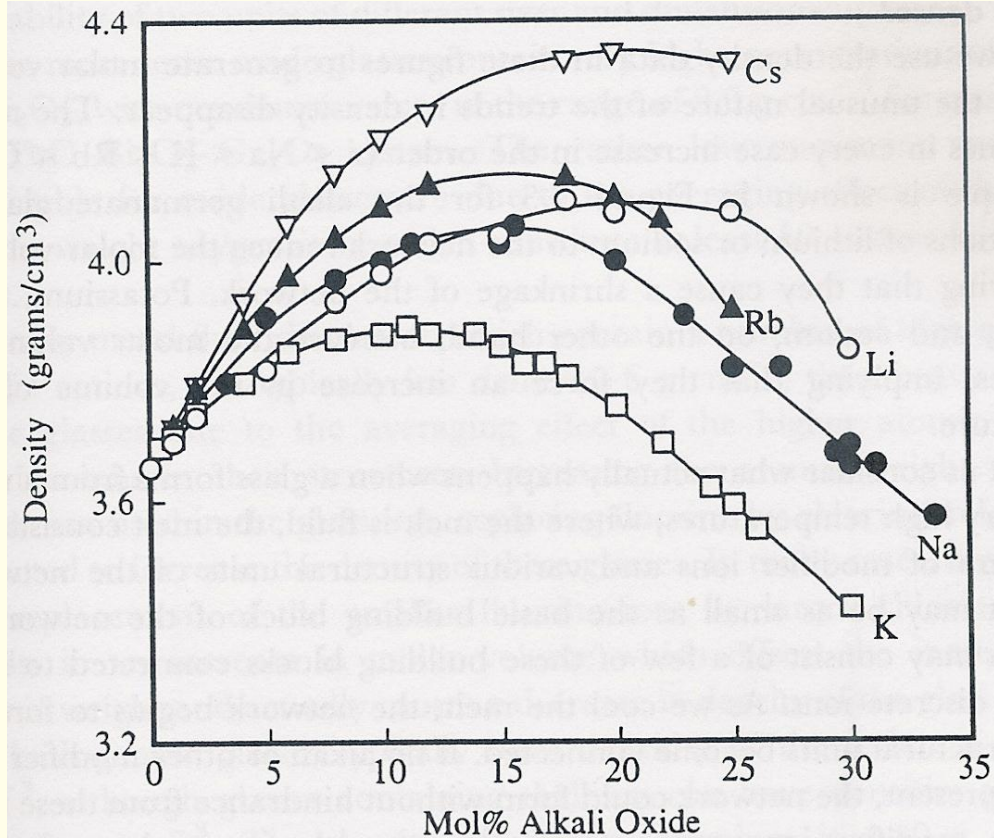

Effect of composition on the density of alkali germanate glasses

The situation is even more complicated in alkali germanate glasses, where not only K-containing glasses are less dense than those containing Na and Li (!), but also the GeO₂-Li₂O glasses with > 20 mol% Li₂O are denser than K-, Na- and Rb-containing glasses. On top of this remarkable behavior, all curves show **maxima** at some intermediate modifier content, a fact known as the *germanate anomaly*.

Mechanical behavior of glass

Glasses are *brittle* materials: only recoverable strains, of the order of 0.1 %.
There is **no plastic deformation**.

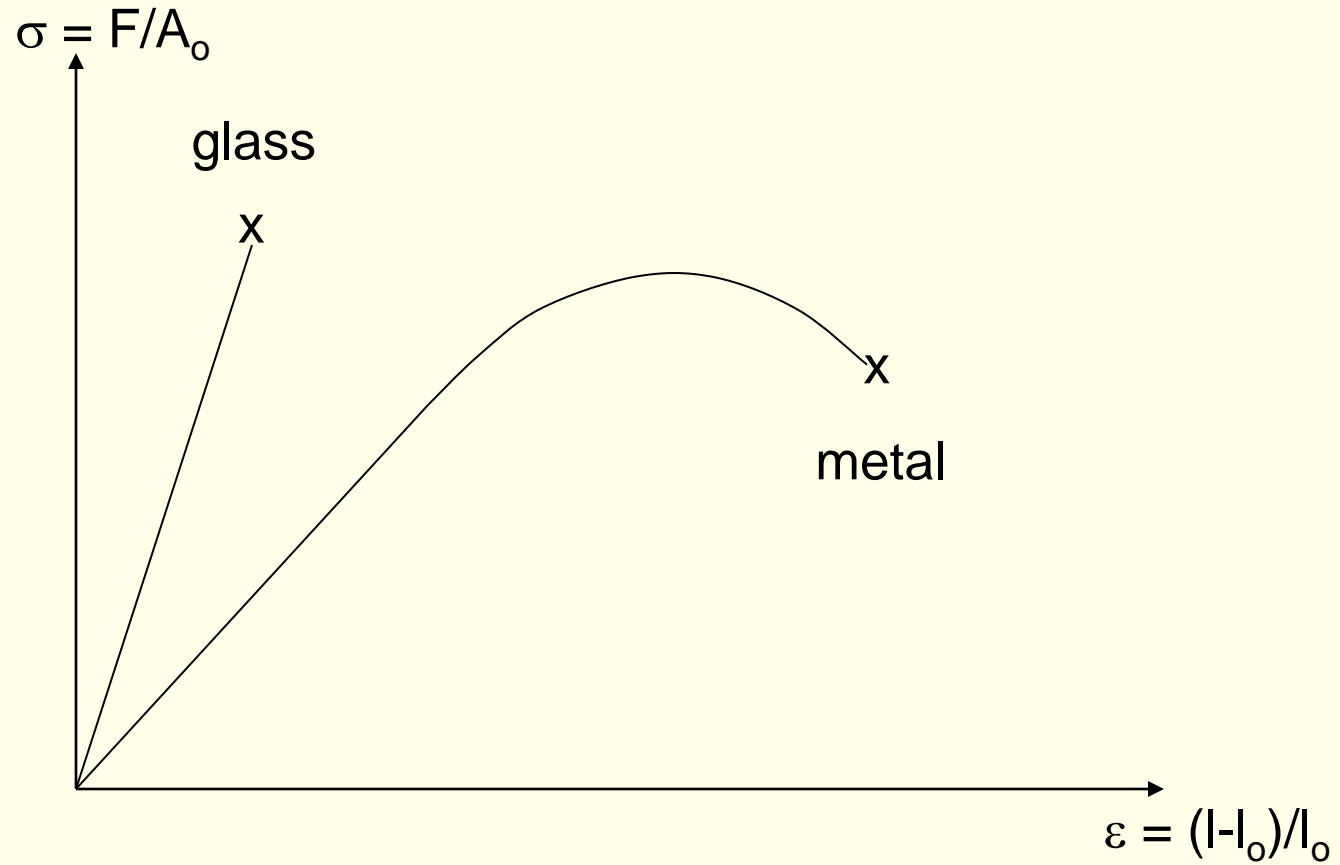

Theoretical tensile strength

Glass fails much more readily **under tension** than under compression. The theoretical *tensile strength* of glass, σ_t , corresponds to the stress needed to separate two atomic “planes”, when the *attractive forces* are at a *maximum*:

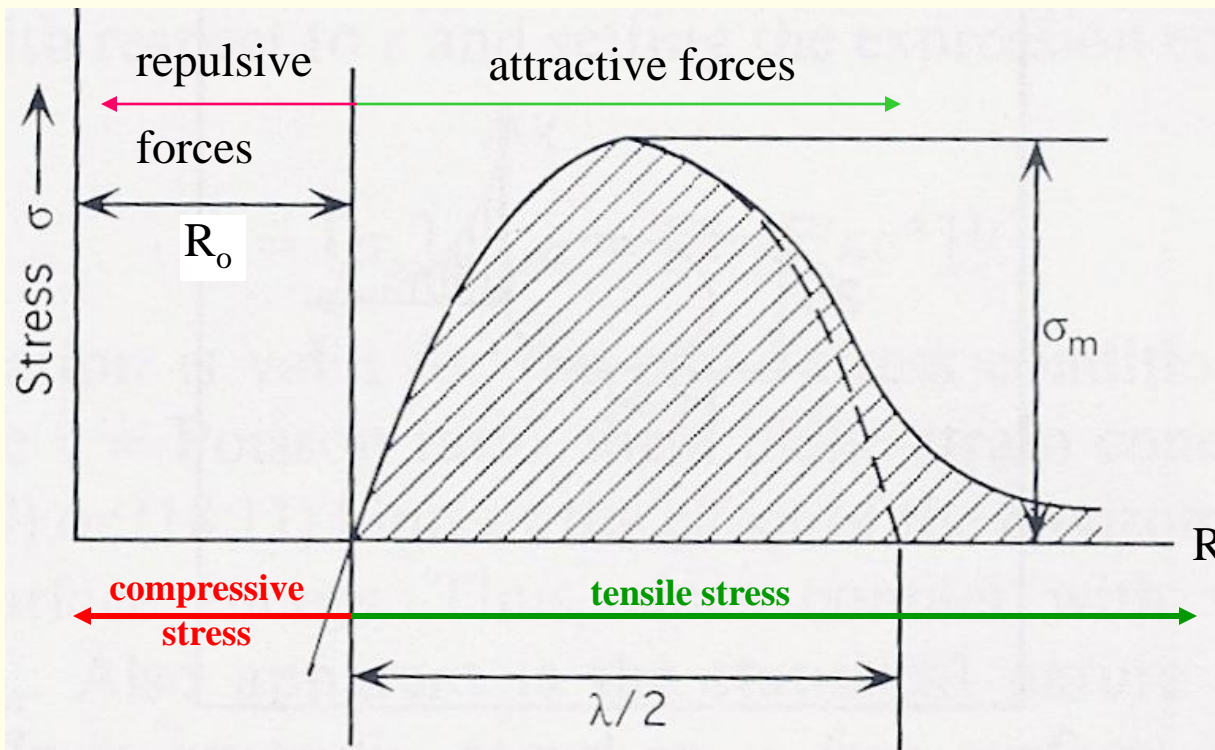

Variation of stress σ with increasing interatomic spacing.

(Adapted from: *Fundamentals of inorganic glasses*, A.K. Varshneya, Academic Press, 1994)

For a glass with an equilibrium interatomic spacing R_o , a Young's modulus E and a surface energy γ , **it can be shown** that (Orowan eq.):

$$\sigma_t = (E \gamma / 4 R_o)^{1/2}$$

For example, for v-SiO₂ ($R_o=0.162$ nm, $E=72$ GPa, $\gamma=2.9$ J/m²), one has:

$$\sigma_t = 18 \text{ GPa} \sim E / 5$$

The actual experimental value (measured at 4 K, after flame polishing) was:

$$\sigma_t = 15 \text{ GPa}$$

Under normal **practical conditions** (at room temperature and without previous surface reconditioning), for v-SiO₂, one measures only:

$$\sigma_t \sim 100 \text{ MPa}$$

more than **100 times less than the theoretical prediction.**

This large difference was attributed by *Griffith* (1920) to the occurrence of microscopic (or even nanoscopic, using today's terminology) **flaws** (or *cracks*) at the surface of ordinary glass specimens, which **act as stress concentrators**, causing glass fracture at an applied stress $\sigma_a \ll \sigma_t$. Such flaws are usually the result of handling or abrasion.

Griffith's model was based on a previous result of elasticity theory due to Inglis (1913), which yielded an expression for the maximum value of the concentrated tensile stress near the tip of an **elliptical crack of major axis $2c$ and crack tip radius ρ** :

$$\sigma_{\max} = 2 \sigma_a (c/\rho)^{1/2}$$

Fracture will occur whenever $\sigma_{\max} \geq \sigma_t$.

Typical example of an elliptical flaw, where the crack tip radius:

$$\rho = b^2 / c$$

is not too small.

However, for very sharp cracks (for which $b/c \ll 1$), their tip radii may reach atomic dimensions. For example, if $\rho \sim 0.2 \text{ nm}$ and $c \sim 1 \text{ }\mu\text{m}$, the *stress concentration factor*:

$$2 (c/\rho)^{1/2} = \sigma_{\text{max}} / \sigma_a$$

will be ~ 140 .

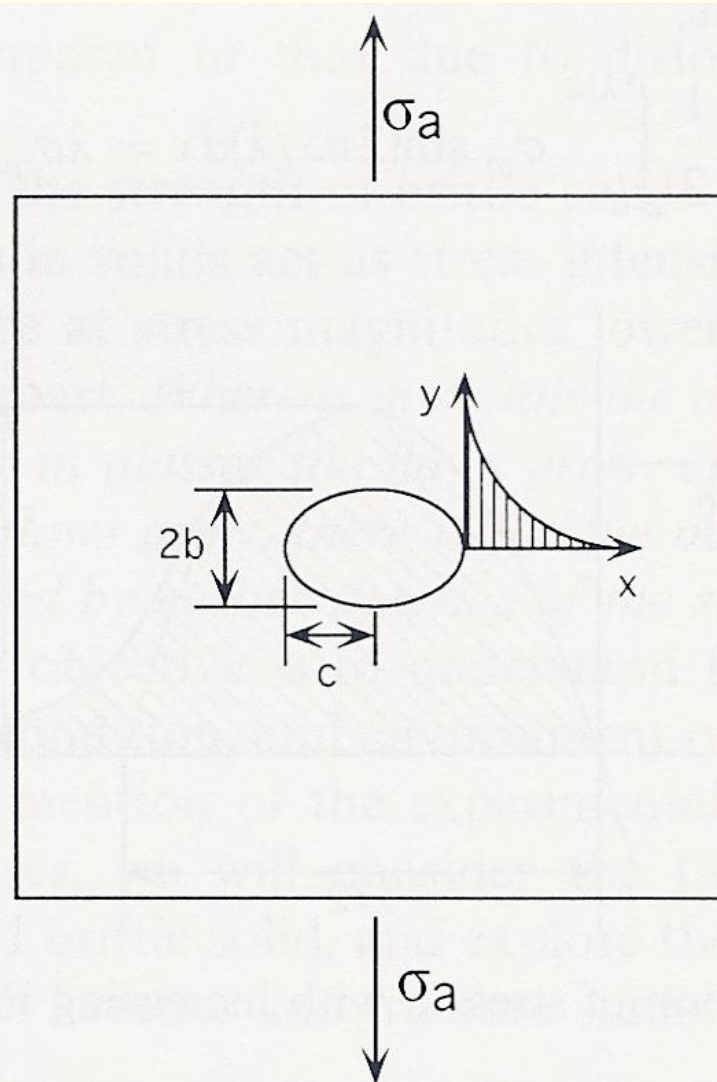

Elliptical flaw in a glass plate under tension.

(Adapted from: *Fundamentals of inorganic glasses*, A.K. Varshneya, Academic Press, 1994)

A combination of **Griffith's and Inglis'** theories eventually leads to the equation:

$$\sigma_t \sim (4 E \gamma / \rho)^{1/2}$$

Comparing this equation with the theoretical estimate of σ_t , one obtains the following estimate of the **crack tip radius**:

$$\rho \sim 16 R_0$$

In the case of uniaxial compression, **Griffith's** model predicts that the theoretical **compressive strength**, σ_c , equals **8 times the tensile strength**, for infinitely sharp cracks ($b/c \rightarrow 0$).

The mechanical strength of brittle materials like glass has a *statistical* nature, with varying populations of cracks from sample to sample (number and size), which account for the usual scattering in measured strength data.

A statistical criterion derived by Weibull (Weibull statistics, similar but not equal to the normal gaussian distribution) is the most suitable in this case.

In 1957, Irwin introduced the *stress intensity factor, K*:

$$K = Y \sigma_a c^{1/2} \quad (\text{in Pa}\cdot\text{m}^{1/2}, \text{ or Nm}^{-3/2})$$

where Y is a shape factor; for surface flaws in a glass, $Y \sim \pi^{1/2}$ and $K \sim \sigma_a(\pi c)^{1/2}$.

For glass specimens with **pre-existing surface flaws** (usually due to handling), **fracture is controlled by crack propagation**. When a **critical stress level**, the applied fracture stress, σ_a^{fr} , is reached for the largest flaw with proper orientation (called the *critical flaw*, of length $2c_{\text{cr}}$), Griffith's criterion determines the occurrence of *catastrophic failure*.

If $\sigma_a < \sigma_a^{\text{fr}}$ (for example, for a glass window **under a static load**), there will be *no failure, unless* the glass part exhibits *static fatigue*, or delayed failure, which consists of *slow crack growth*, under a **sub-critical**, static applied **stress**, until the most severe crack reaches the length $2c_{\text{cr}}$ and brittle fracture occurs at that time.

Such phenomenon, in common silicate glasses, is usually **attributed to stress corrosion at the crack tip**, where **strained bonds are broken**, often by the combined action of stress and atmospheric humidity:

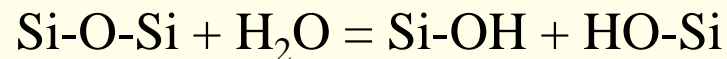

forming a gel-like region where the crack is able to propagate under sub-critical conditions.

For the **critical stress level**, the stress intensity factor becomes $K_{\text{Ic}} = Y \sigma_a^{\text{fr}} c_{\text{cr}}^{1/2}$ and it is called the glass **fracture toughness**.

Crack velocity, $v = dc/dt$, as a function of K , for soda-lime-silica glass, in a nitrogen atmosphere with humidity values between $\sim 0 - 100\%$.

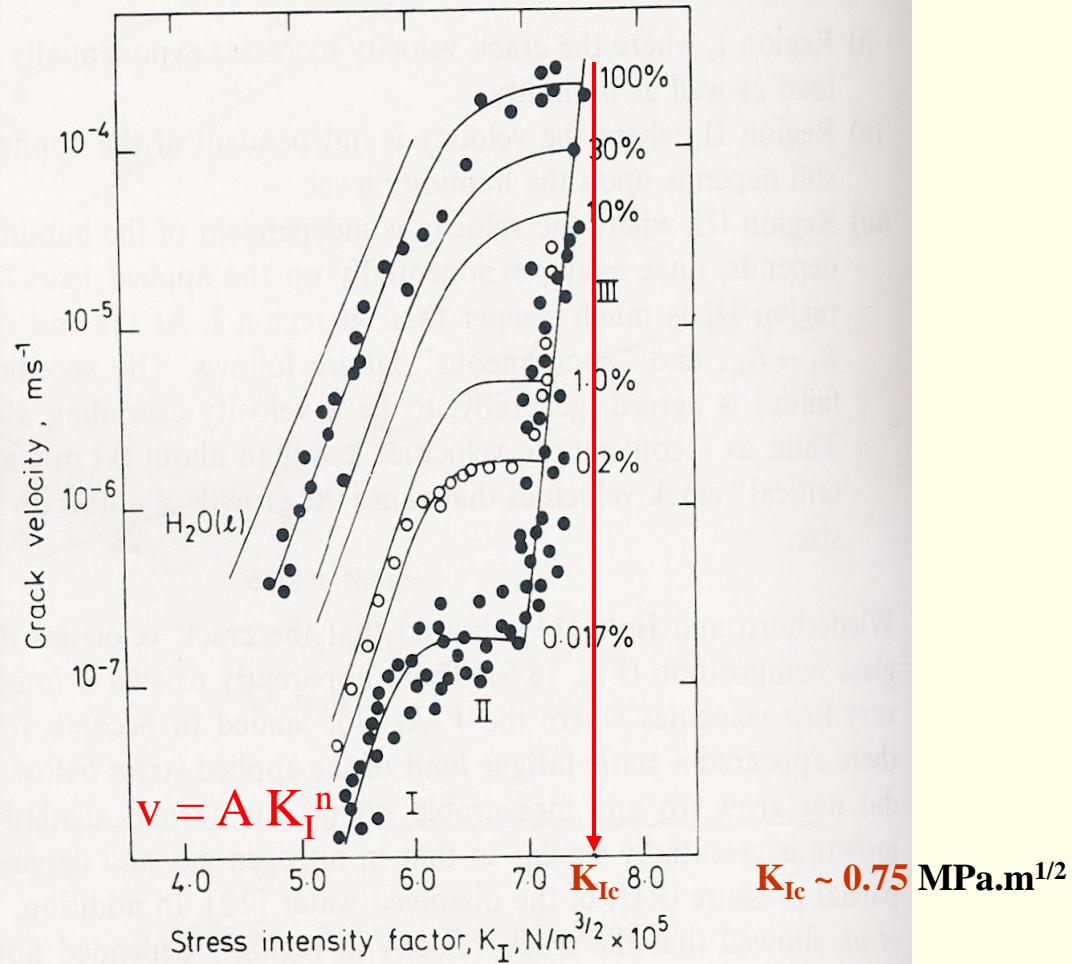

Crack velocity vs. applied intensity factor for soda lime silica glass in N_2 gas of varying levels of humidity. (After Wiederhorn [11a]. Reproduced with permission of The American Ceramic Society.)

(Adapted from: *Fundamentals of inorganic glasses*, A.K. Varshneya, Academic Press, 1994)

Region I – crack velocity increases exponentially with the applied load and also with the humidity; the dependence on the applied load may be expressed as:

$$v = A K_I^n$$

where **n** is the so-called *stress corrosion susceptibility parameter*, varying between ~ 12 - 35 for most (modified) glasses, but reaching a value of 72 for v-SiO₂. The lower n is, the larger is the stress corrosion susceptibility of the glass.

Region II – crack velocity depends on the humidity level, but is independent of the applied stress.

Region III – crack velocity depends on the applied stress, but it is independent of the humidity. The slope is steeper than in region I. At the end of region III, crack velocity reaches ~ 0.1 m/s and K_I reaches the critical value K_{Ic} , the fracture toughness, causing spontaneous failure.

Silica, Vycor and Pyrex glasses exhibit only region I prior to catastrophic failure.

Typical shell-like shape of glass fracture. Next to the origin of the catastrophic failure, where the *critical flaw* was located, lies a shiny region called the *mirror*, which ends in a misty texture called the *mist*. The mist begins to form when the fracture front approaches its terminal velocity, usually $\sim 60\%$ of the transverse acoustic velocity, $v_t \sim 3$ km/s. The rougher *hackle* region surrounding the mist represents the motion of the fracture front at terminal velocity, after which it decelerates, producing *Wallner lines*.

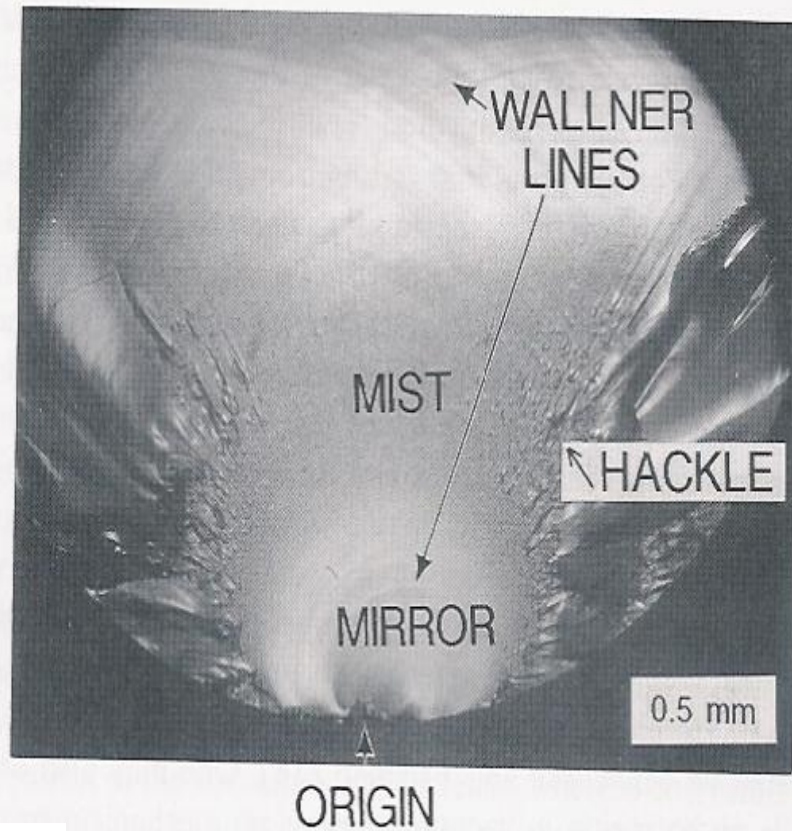

The *fractographic analysis* of broken glass may yield very important information regarding the cause of the fracture.

Fracture surface of a soda lime silica glass rod broken in bending at room temperature. (80 \times)
(Adapted from: *Fundamentals of inorganic glasses*, A.K. Varshneya, Academic Press, 1994)

References:

<http://www.lehigh.edu/imi/OptoGlassCourse.htm> (Rui M. Almeida)

A.K. Varshneya, **Fundamentals of Inorganic Glasses**, 2nd Edition, Society of Glass Technology, (Sheffield, UK, 2006).

James E. Shelby, **Introduction to Glass Science and Technology**, 2nd Edition, The Royal Society of Chemistry (Cambridge, U.K., 2005).

P.J. Doyle, **Glass-making today**, Portcullis Press (Redhill, UK, 1979).