

Optical Microfibers and Nanofibers Fabrication, Properties and Applications

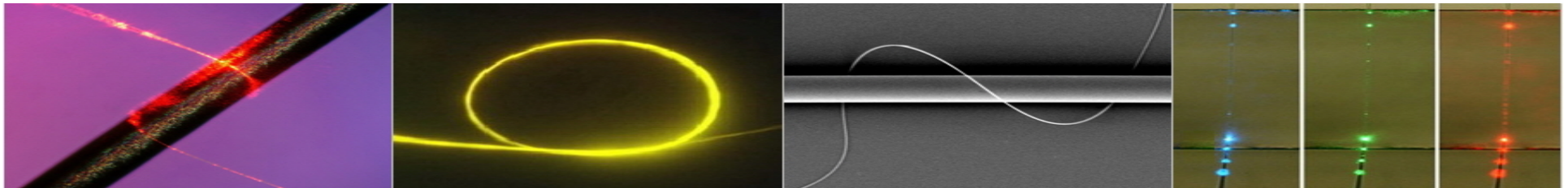

Limin Tong

State Key Laboratory of Modern Optical Instrumentation
Department of Optical Engineering
Zhejiang University
Hangzhou, China

2010-01-12



Outline

- Introduction

1. Fabrication

2. Optical Properties

3. Potentials and Applications

- Summary

Outline

- Introduction

1. Fabrication

2. Optical Properties

3. Potentials and Applications

- Summary

▫ Introduction

● Optical fibers



In the past 40 years, optical fibers have been finding successful applications in

- Optical communications
- Optical sensing
- Power delivery
- Nonlinear fiber optics



Nobel Prize in Physics 2009

▫ Introduction

● Optical fibers

Basically

Linear Optics

**Guide light/photons
linearly**

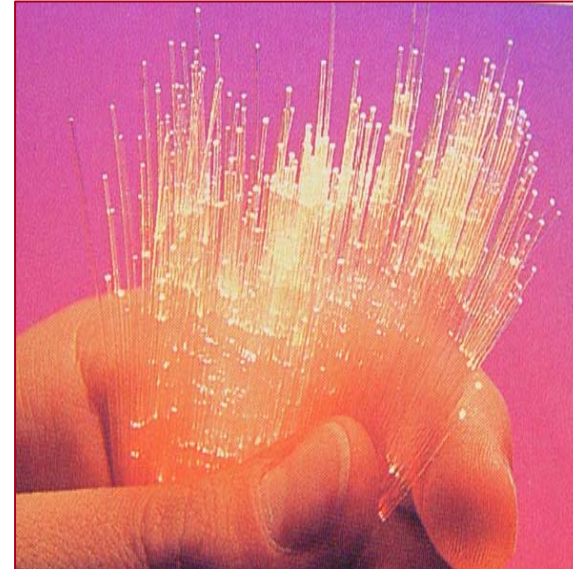

▫ Introduction

● Optical fibers

Basically

Linear Optics
Guide light/photons
linearly

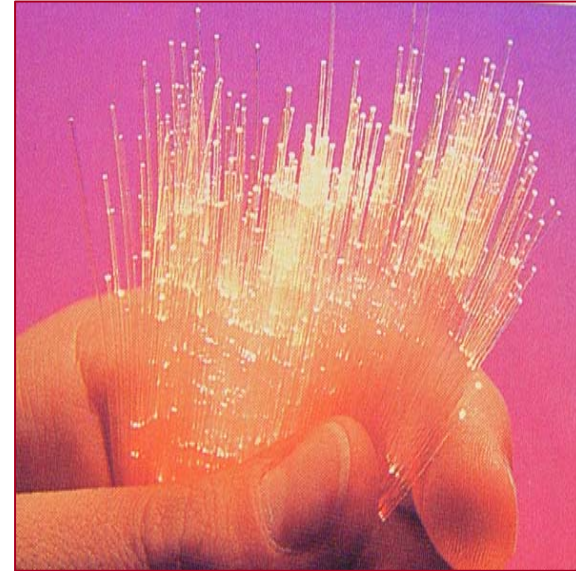

When the light is
powerful enough

Nonlinear Optics
Absorb & Generate
new light/photons

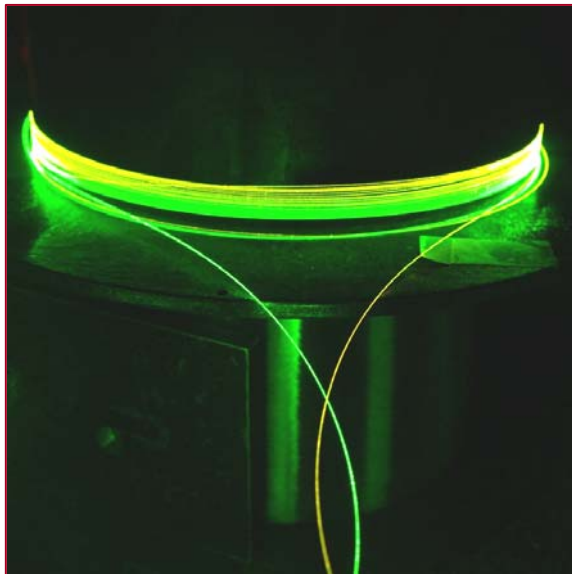

▫ Introduction

● Miniaturization of optical fibers

Fiber-optic technology

- **Rapid development of nanotechnology**
- **Fiber optic devices with higher performances**

e.g., Higher sensitivity
Faster response
Higher density
Smaller footprint

▫ Introduction

● Miniaturization of optical fibers

Fiber-optic technology

- Rapid development of nanotechnology
- Fiber optic devices with higher performances

e.g., Higher sensitivity
Faster response
Higher density
Smaller footprint



It is desired to miniaturize optical fibers

▫ Introduction

● Miniaturization of optical fibers

Also, it is always interesting to explore new opportunities of an optical fiber

▫ Introduction

● Miniaturization of optical fibers

Also, it is always interesting to explore new opportunities of an optical fiber

For example

- **Besides the photon, can it guide something else?**
e.g., an atom, a molecules, or a dust

▫ Introduction

● Miniaturization of optical fibers

Also, it is always interesting to explore new opportunities of an optical fiber

For example

- **Besides the photon, can it guide something else?**
e.g., an atom, a molecules, or a dust
- **As electromagnetic waves, can the photons in a glass fiber behavior like the electrons in a copper wire?**
e.g., making a connection by a simple touch

▫ Introduction

● Miniaturization of optical fibers

 **The answer:** Yes, if the fiber is thin enough

Optical microfiber or nanofiber



Therefore, the motivation of shrinking optical fibers is:
Explore new opportunities on new dimensions

▫ Introduction

● Miniaturization of optical fibers

For this purpose



One of the simplest approach

Drawing a standard optical fiber to micro or nanometer scale

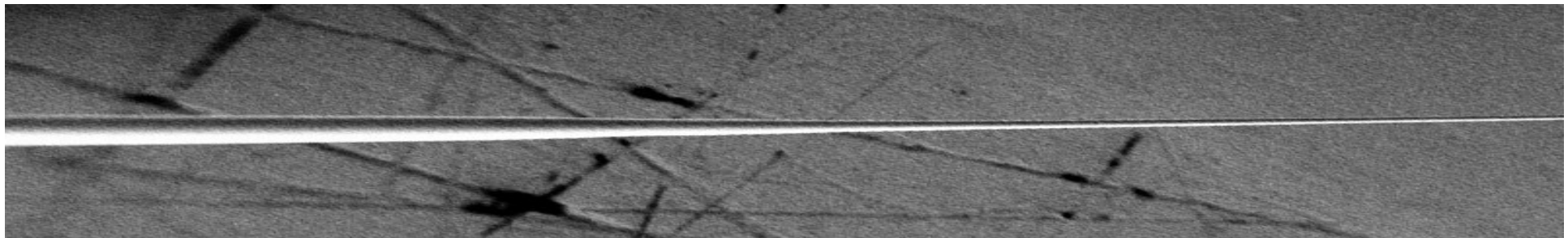

▫ Introduction

■ Optical micro/nanofiber

an optical fiber with diameter close to or thinner than the wavelength of the light it guided

$$\text{i.e., } D_{\text{fiber}} \approx \lambda \text{ or } D_{\text{fiber}} < \lambda$$

▫ Introduction

■ Optical micro/nanofiber

an optical fiber with diameter close to or thinner than the wavelength of the light it guided

$$\text{i.e., } D_{\text{fiber}} \approx \lambda \quad \text{or} \quad D_{\text{fiber}} < \lambda$$

sometimes  it is called

**“Subwavelength-diameter wires” / “Microfiber” /
“Nanofiber” / “Nanotaper” / “Nanowire” /
“Fiber taper” / “Ultrathin optical fiber” ...**

Subwavelength-diameter silica wires for low-loss optical wave guiding

Limin Tong^{1,2}, Rafael R. Gattass¹, Jonathan B. Ashcom^{1*}, Sailing He², Jingyi Lou², Mengyan Shen^{1,3}, Iva Maxwell¹ & Eric Mazur¹

¹Department of Physics and Division of Engineering and Applied Sciences, Harvard University, Cambridge, Massachusetts 02138, USA

²Centre for Optical and Electromagnetic Research and Department of Physics,

PHYSICAL REVIEW A 73, 013819 (2006)

Scattering of an evanescent light field by a single cesium atom near a nanofiber

Fam Le Kien,^{1,*} V. I. Balykin,^{1,2} and K. Hakuta¹

¹Department of Applied Physics and Chemistry, University of Electro-Communications, Chofu, Tokyo 182-8585, Japan

February 15, 2008 / Vol. 33, No. 4 / OPTICS LETTERS

Mach-Zehnder interferometers assembled with optical microfibers or nanofibers

Yuhang Li and Limin Tong*

State Key Laboratory of Modern Optical Instrumentation, and Department of Optical Engineering, Zhejiang University, Hangzhou 310027, China

*Corresponding author: phyton@zju.edu.cn

PRL 99, 163602 (2007)

PHYSICAL REVIEW LETTERS

week ending
19 OCTOBER 2007

Cold-Atom Physics Using Ultrathin Optical Fibers: Light-Induced Dipole Forces and Surface Interactions

G. Sagué, E. Vetsch, W. Alt, D. Meschede, and A. Rauschenbeutel*

Institut für Angewandte Physik, Universität Bonn, Wegelerstr. 8, 53115 Bonn, Germany

Optical microfiber loop resonator

M. Sumetsky,^{a)} Y. Dulashko, J. M. Fini, and A. Hale
OFS Laboratories, 19 Schoolhouse Road, Somerset, New Jersey 08873

(Received 4 November 2004; accepted 8 March 2005; published online 13

We experimentally demonstrate an optical microfiber loop resonator. The n free space by creating a loop from the subwavelength-diameter waist of a

Ultra-low-loss optical fiber nanotapers

Gilberto Brambilla, Vittoria Finazzi, and David J. Richardson

University of Southampton, Highfield, Southampton, SO17 1BJ, UK
gb2@orc.soton.ac.uk

<http://www.orc.soton.ac.uk>

apers with a waist size larger than 1µm are nications and sensor applications. However the cal fiber tapers with subwavelength diameters e impractical due to difficulties associated with nness and diameter uniformity. In this paper we

New Journal of Physics

The open-access journal for physics

Single atoms on an optical nanofibre

K P Nayak and K Hakuta¹

Department of Applied Physics and Chemistry, University of Electro-Communications, Chofu, Tokyo 182-8585, Japan

163603 (9pp)

s can be detected using a sub-fibre, and the fact that sin can be readily guided into a ngle atoms around the nanof is the excitation spectrum of

letters to nature

Subwavelength-diameter silica wires for low-loss optical wave guiding

Limin Tong, Rafael R. Gattass, Jonathan B. Ashcom, Sailing He, Jingyi Lou, Mengyan Shen, Iva Maxwell & Eric Mazur

Department of Physics and Division of Engineering and Applied Sciences, Harvard University, Cambridge, Massachusetts 02138, USA
Centre for Optical and Electromagnetic Research and Department of Physics,

APPLIED PHYSICS LETTERS 86, 161108 (2004)

Optical microfiber loop resonator

M. Sumetsky, Y. Dulashko, J. M. Fini, and A. Hale
OFS Laboratories, 19 Schoolhouse Road, Somerset, New Jersey 08873

(Received 4 November 2004; accepted 8 March 2005; published online 13 March 2005)

We experimentally demonstrate an optical microfiber loop resonator. The resonator is formed in free space by creating a loop from the subwavelength-diameter waist of a microfiber.

Ultra-low-loss optical fiber nanotapers

Gilberto Brambilla, Vittoria Finazzi, and David J. Richardson

Optoelectronics Research Centre, University of Southampton, Highfield, Southampton, SO17 1BJ, UK
g.b2@orc.soton.ac.uk

http://www.orc.soton.ac.uk

Microfibers with waist size larger than 1µm are used for sensor applications. However the loss in microfibers with subwavelength diameters is high due to difficulties associated with diameter uniformity. In this paper we

PHYSICAL REVIEW A 73, 013819 (2006)

Scattering of an evanescent light field by a single cesium atom near a nanofiber

Fam Le Kien, 1

Department of Applied Physics and Chemistry, City University of Hong Kong, Tat Chee Avenue, Kowloon, Hong Kong

February 2006

Mach-Zehnder interferometer using optical microfibers

Yuhang Li and Lin Zhang

State Key Laboratory of Modern Optical Instrumentation, Zhejiang University, Hangzhou 310027, China
*Corresponding author: phytong@zju.edu.cn

In this talk for simplicity
Micro/nanofiber

Journal of Physics: Applied Physics
Applied Physics Letters
Progress in Optics
Progress in Quantum Electronics
Progress in Surface Science
Progress in Theoretical Physics

Optical nanofiber

K P Nayak and K Hakuta

Department of Applied Physics and Chemistry, University of Tsukuba, 1-1-1 Tennodai, Tsukuba, Ibaraki 305-8585, Japan

PRL 99, 163602 (2007)

PHYSICAL REVIEW LETTERS

week ending
19 OCTOBER 2007

Cold-Atom Physics Using Ultrathin Optical Fibers: Light-Induced Dipole Forces and Surface Interactions

G. Sagué, E. Vetsch, W. Alt, D. Meschede, and A. Rauschenbeutel

Institut für Angewandte Physik, Universität Bonn, Wegelerstr. 8, 53115 Bonn, Germany

163602 (9pp)

atoms can be detected using a sub-wavelength optical fibre, and the fact that single atoms can be readily guided into a microfiber. The excitation spectrum of

▫ Introduction

● What does an optical microfiber look like ?

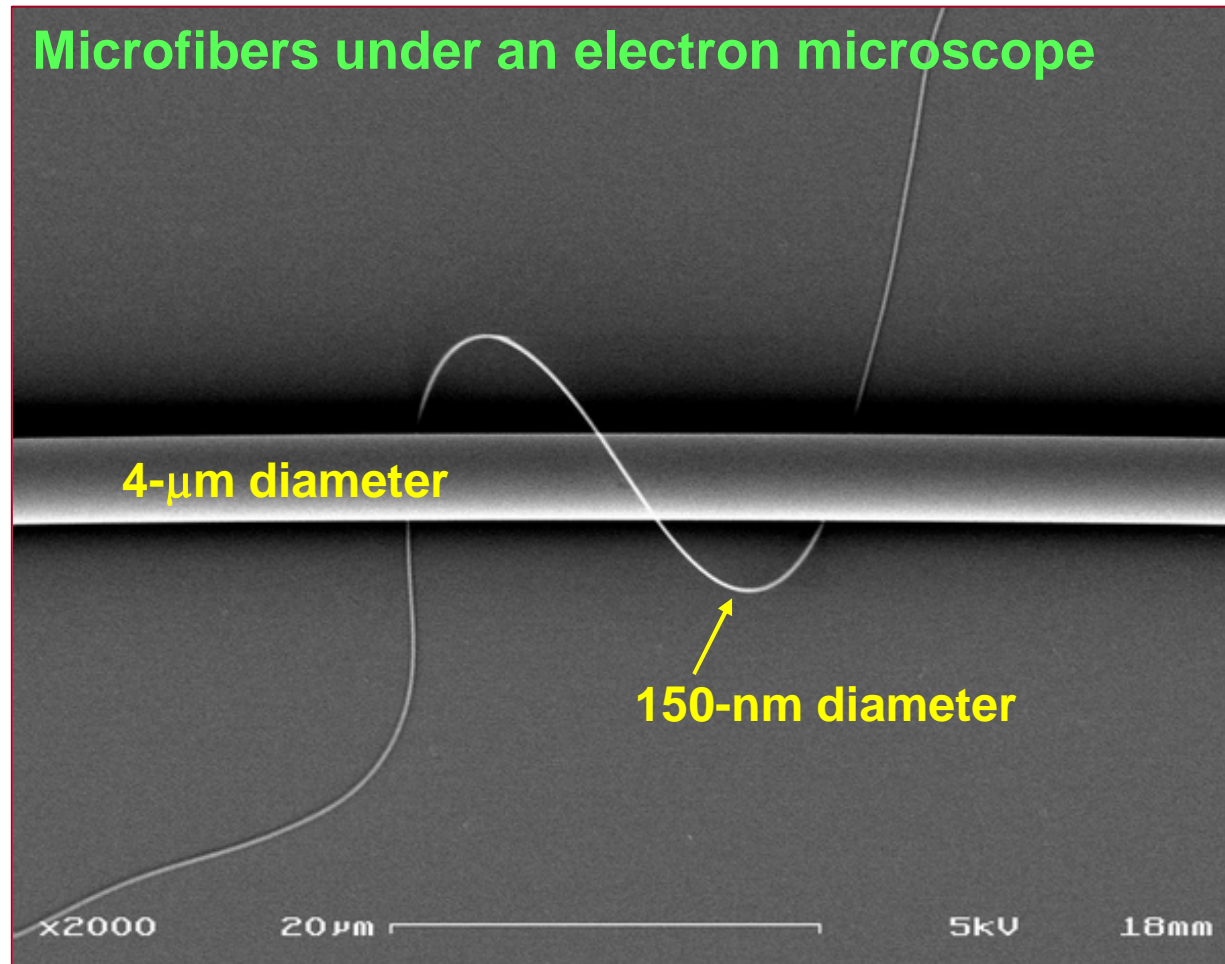

Introduction

- What does an o

Scale of a
microfiber

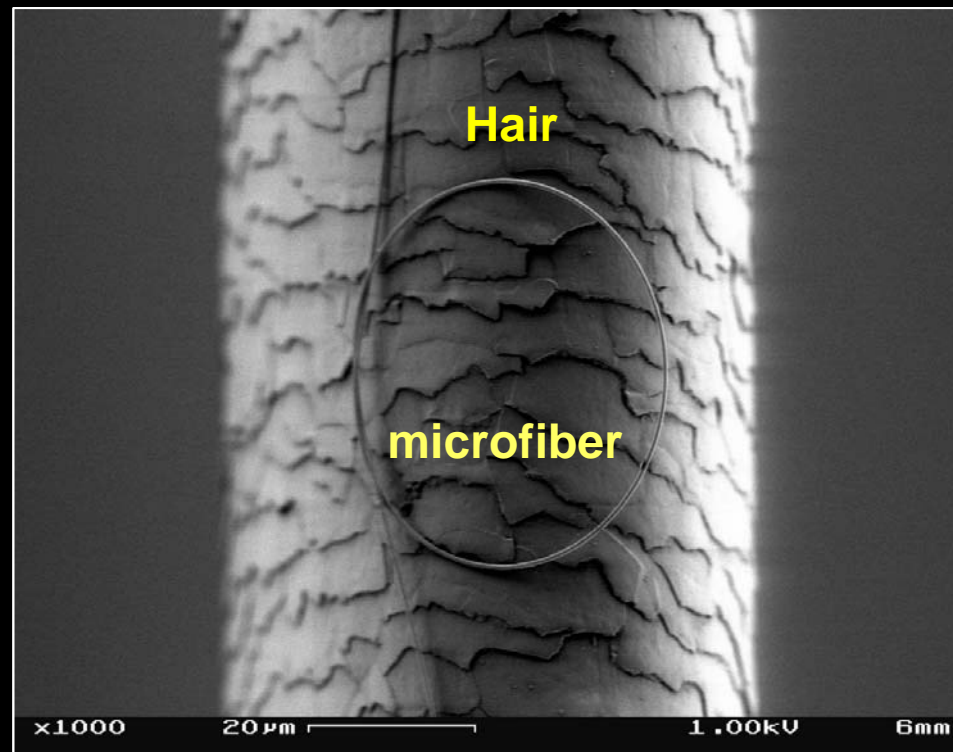
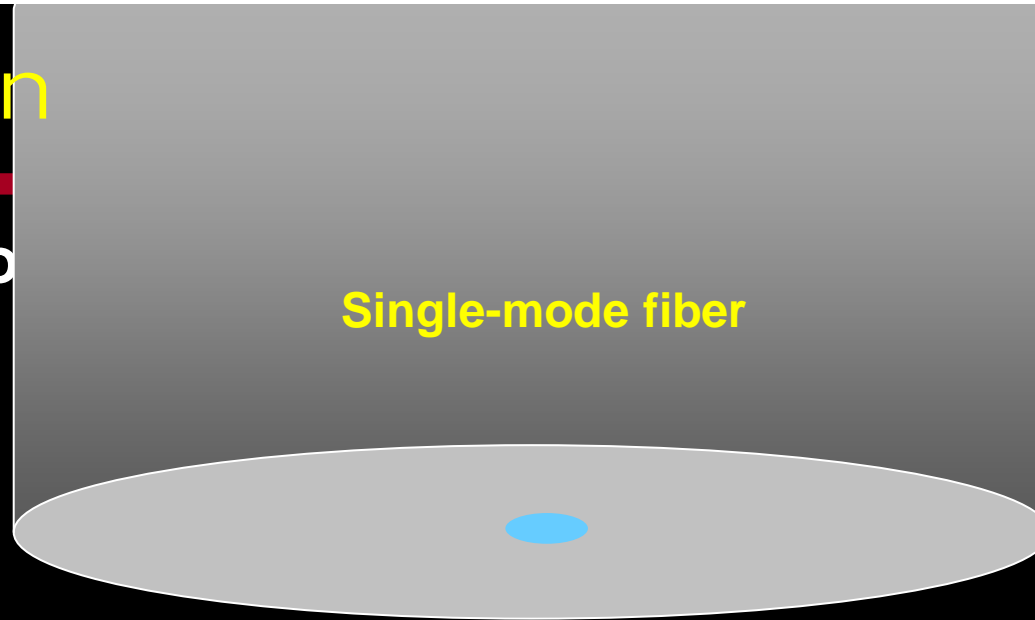

Introduction

● What does an o

Scale of a
microfiber

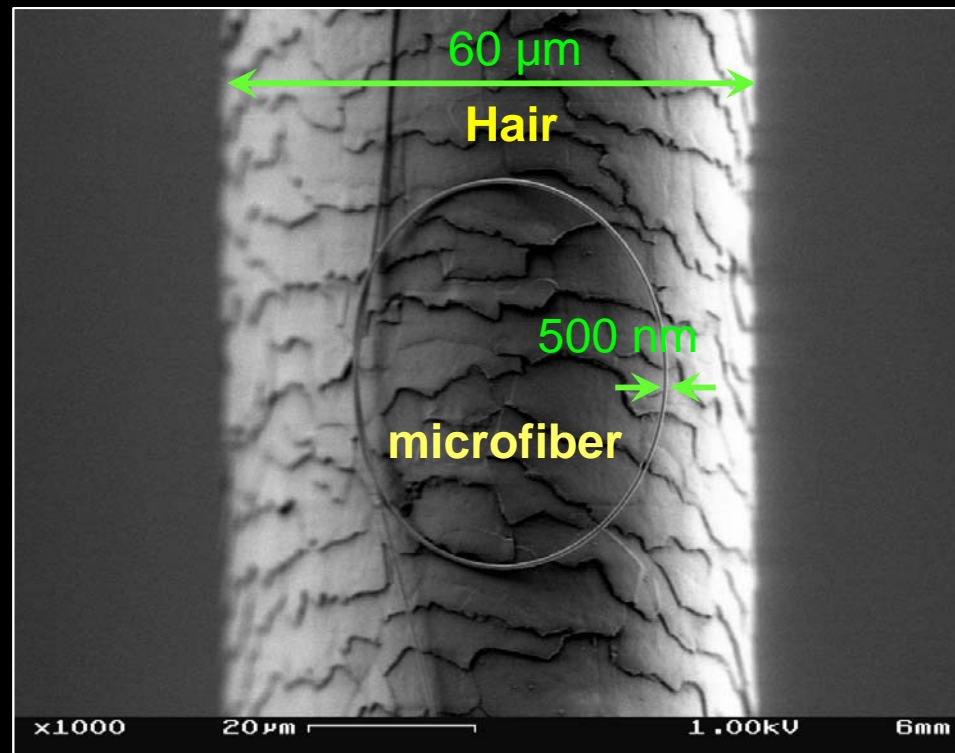
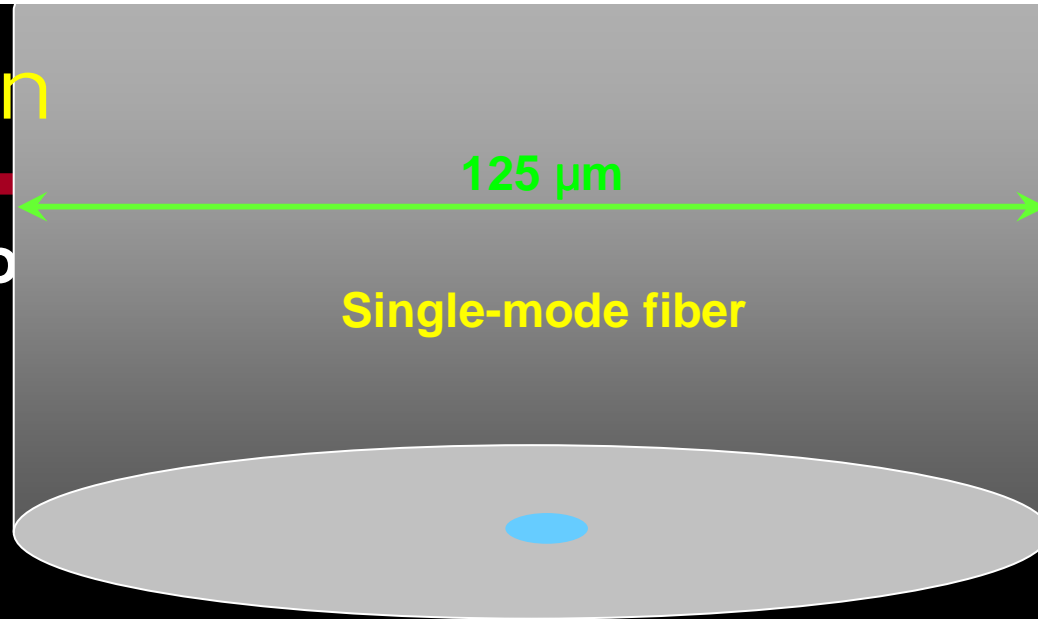

▫ Introduction

● What does an optical microfiber look like ?

Due to its large length, despite of its thin diameter, a microfiber is visible to the naked eye.

Nanoscale glass

Movie 0-1: A 350-nm-diameter nanofiber captured by a digital camera using close-up mode, the fiber is illuminated by a 633-nm-wavelength light guided along it



▫ Introduction

● What's new of guiding light with a microfiber?

Low-loss optical waveguiding with microfibers ($D=360\text{ nm}$, $\lambda=633\text{ nm}$)

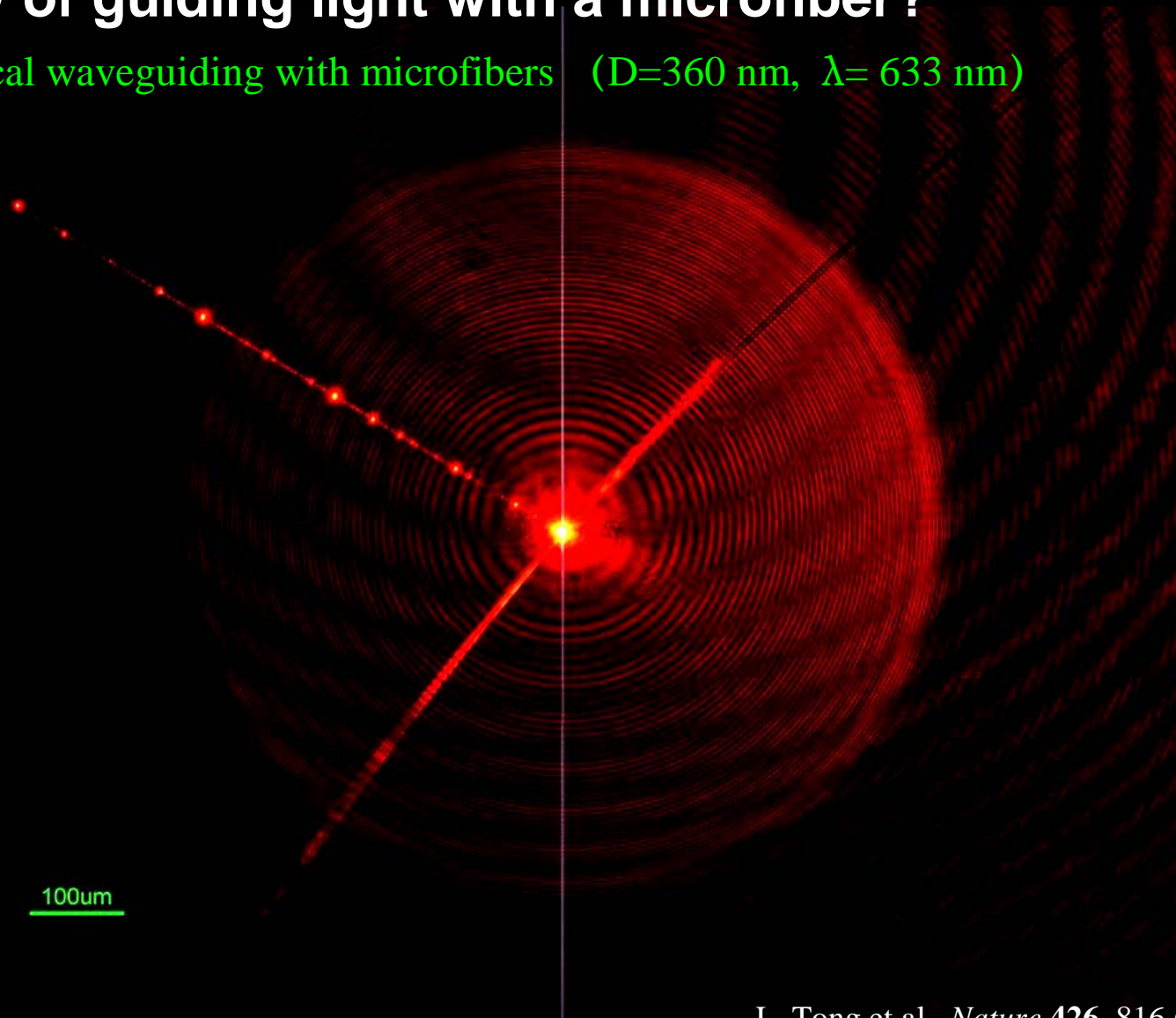

▫ Introduction

● What's new of guiding light with a microfiber?

Low-loss optical waveguiding with microfibers ($D=360\text{ nm}$, $\lambda=633\text{ nm}$)

Very small mode area

Tight optical confinement

High fraction of evanescent fields

Enhanced field intensity on surface

Large waveguide dispersion

100 μm

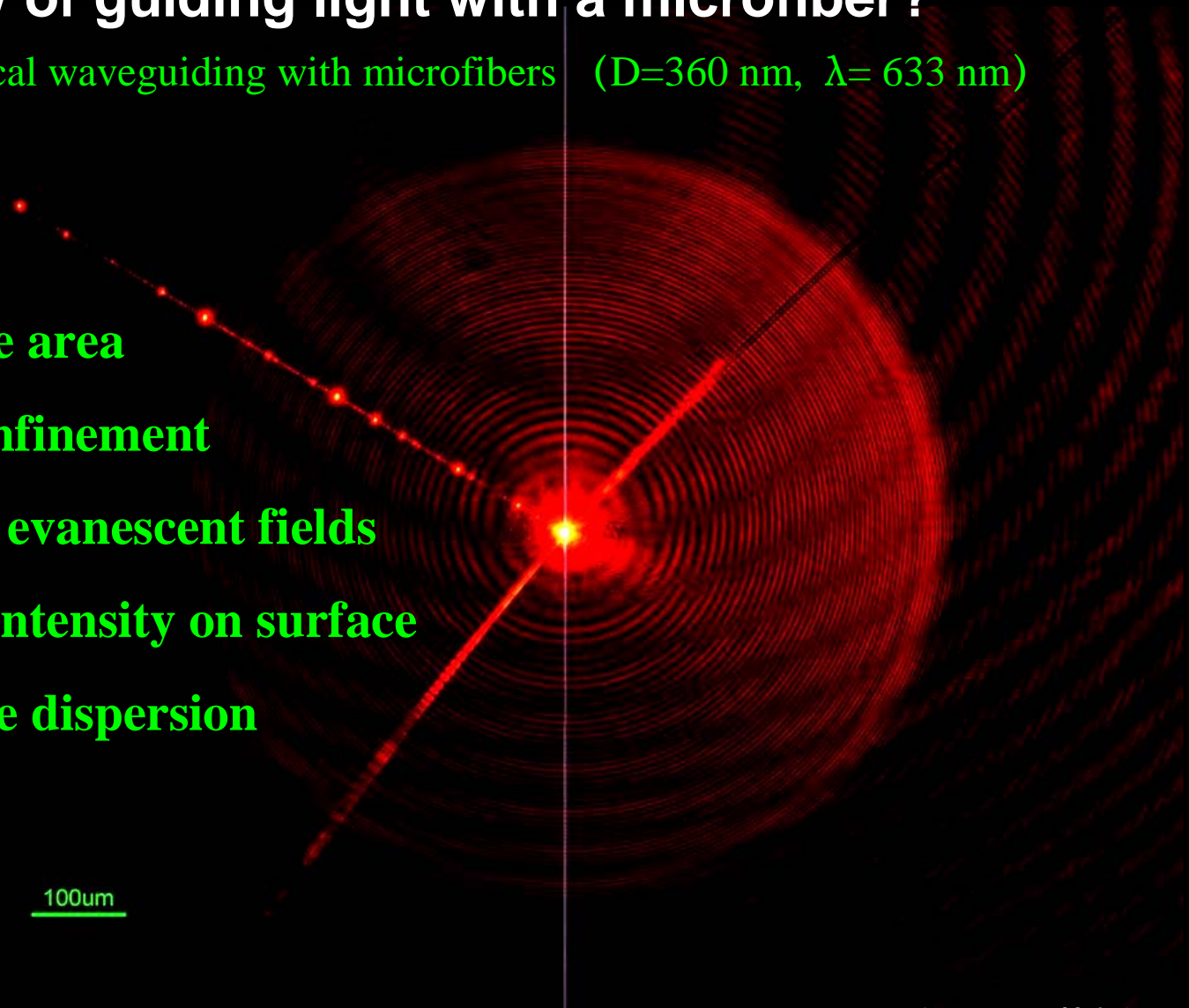
A micrograph showing a single microfiber (a thin red line) extending from the top left towards the center. A bright red laser beam is focused on the fiber, creating a central spot. Concentric red rings radiate outwards from this spot, representing the evanescent fields of the light. A vertical white line is drawn through the center of the fiber. A scale bar at the bottom left indicates 100 micrometers.

▫ Introduction

● What's new of guiding light with a microfiber?

Low-loss optical waveguiding with microfibers ($D=360\text{ nm}$, $\lambda=633\text{ nm}$)

Very small mode area

Tight optical confinement

High fraction of evanescent fields

Enhanced field intensity on surface

Large waveguide dispersion

**New opportunities
for Photonics**

100um

▫ Introduction

● Motivation for working on microfibers

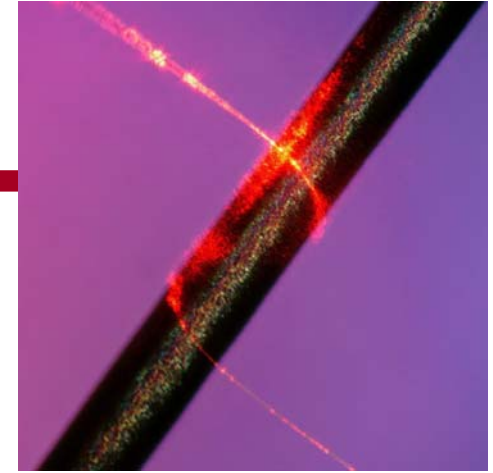

which makes it possible to combine **fiber optics** with **near-field optics**, **nonlinear optics**, **plasmonics** and **quantum optics** on micro/nanoscale, for both fundamental research and technological applications



Optical communication

Optical sensing

Optical computing

Quantum information

...

□ Introduction

■ Next Generation Fibers

G. Brambilla, “Next generation fibers: Optical fibers go nano”, *Laser Focus World*, October 2007, p85-88.

Optical fibers go nano

GILBERTO BRAMBILLA

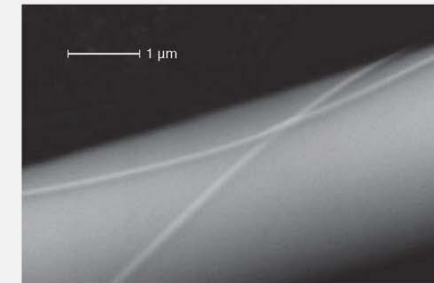

FIGURE 1. Two nanowires with radii of 30 and 50 nm manufactured from standard telecom optical fibers (around which they are entwined) are shown in a scanning-electron micrograph. (Courtesy of the University of Southampton)

Nanoscience and nanotechnology have attracted much interest in recent years because materials exhibit novel properties when structured at nanometer dimensions. In the last two decades, nanowires and subwavelength

wires have been fabricated from a variety of materials using a wide range of techniques, including electron-beam lithography, laser ablation, templates, vapor-liquid-solid techniques, physical- or chemical-vapor deposition, and sol-gel.

Although optical nanowires have previously been fabricated from silica, most have exhibited an irregular profile along their length. Surface roughness and length inhomogeneity appear to have limited the loss levels that could be reliably achieved, and thus their usefulness for optical applications.

Nanowires can also be drawn from optical fibers; this process results in very low surface roughness and high homogeneity. The low optical loss of these nanowires opens the way to a host of new optical devices for communications, sensing, biology, and chemistry.

Optical-fiber nanowires are fabricated by adiabatically

stretching optical fibers, preserving the original fiber dimensions at the input and output ends and allowing ready splicing to standard fibers and fiber components. These fiber pigtailed structures have macroscopic dimensions and allow the manipulation of a single nanowire without the expensive instrumentation typical of the

nano world.

With large evanescent fields and high optical nonlinearity, nanofibers drawn from optical fiber are well suited for optical sensors and other devices. Their standard-size fiber ends allow for easy coupling of light in and out.

Flame brushing

In the last four years, the manufacture of nanowires from optical fibers has been established as a methodology to reliably produce structures with a transmission loss low enough to be used for optical devices. Among the top-down techniques, the “flame-brushing” technique provides the longest

and most uniform nanowires with the lowest measured loss. Originally developed for the manufacture of fiber tapers and couplers, flame brushing is based on a small flame moving under an optical fiber that is being stretched. The control of the flame movement and the fiber stretch can be used to define the taper shape to an extremely high degree of accuracy. Although taper diameters in the range of 1 μm can be eas-

GILBERTO BRAMBILLA is a Royal Society Senior Research Fellow at the Optoelectronics Research Centre, University of Southampton, Southampton SO17 1BJ, England; e-mail: gb2@orc.soton.ac.uk.

Outline

- Introduction

1. Fabrication

2. Optical Properties

3. Potentials and Applications

- Summary

1. Fabrication of Microfibers

1.1 How to fabricate a microfiber?

First work was reported in 19th century

C. V. Boys, *Phil. Mag.* **23**, 489 (1887).

“On the production, properties, and some suggested uses of the finest threads”

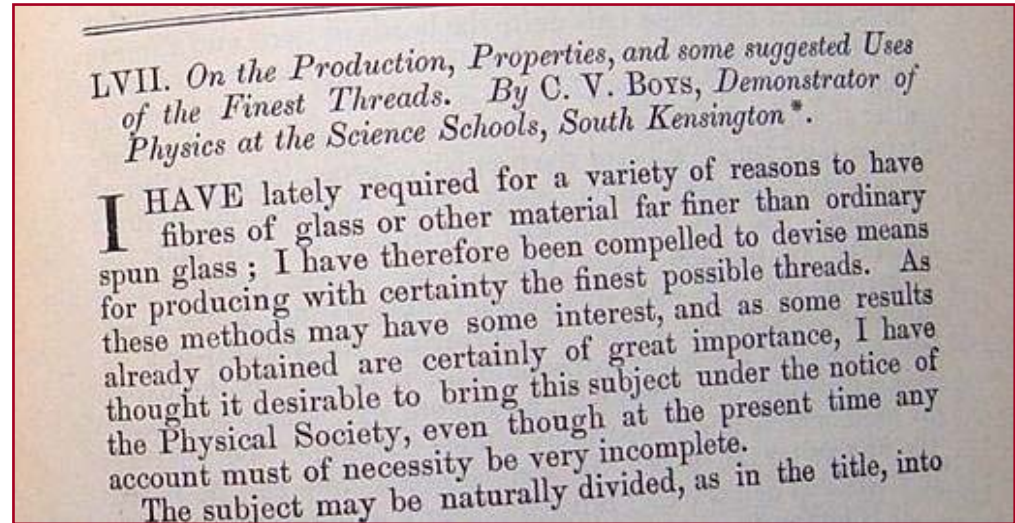

1. Fabrication of Microfibers

1.1 How to fabricate a microfiber?

First work was reported in 19th century

C. V. Boys, *Phil. Mag.* **23**, 489 (1887).

“On the production, properties, and some suggested uses of the finest threads”

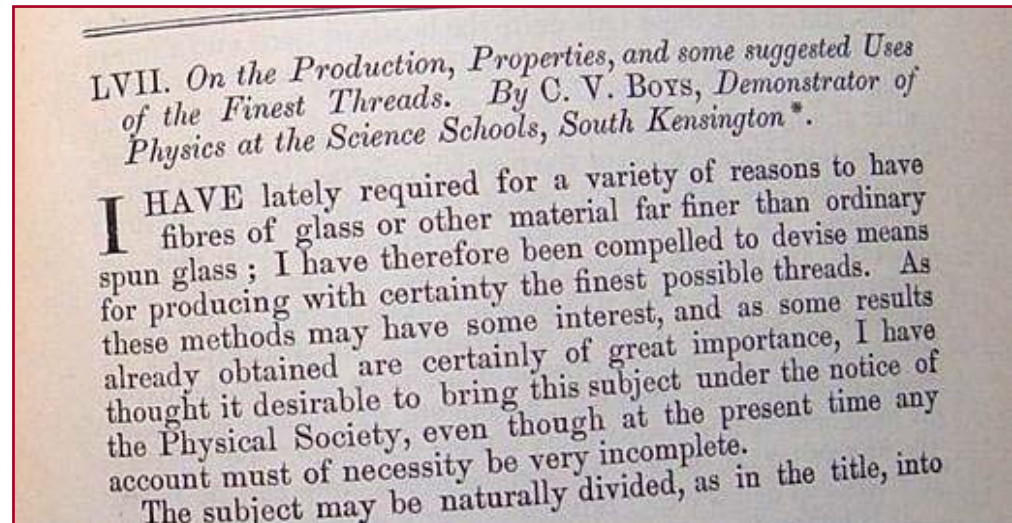

Flame-heated drawing of molten glass → Finest threads

→ $D \sim \mu\text{m}$ (They did not really know, no electron microscope at that time)

Applications

19th century: “Finest threads” → Elasticity → Spring for galvanometer

1. Fabrication of Microfibers

1.1 How to fabricate a microfiber?

Taper drawing fibers heated by flame, electric heater or laser

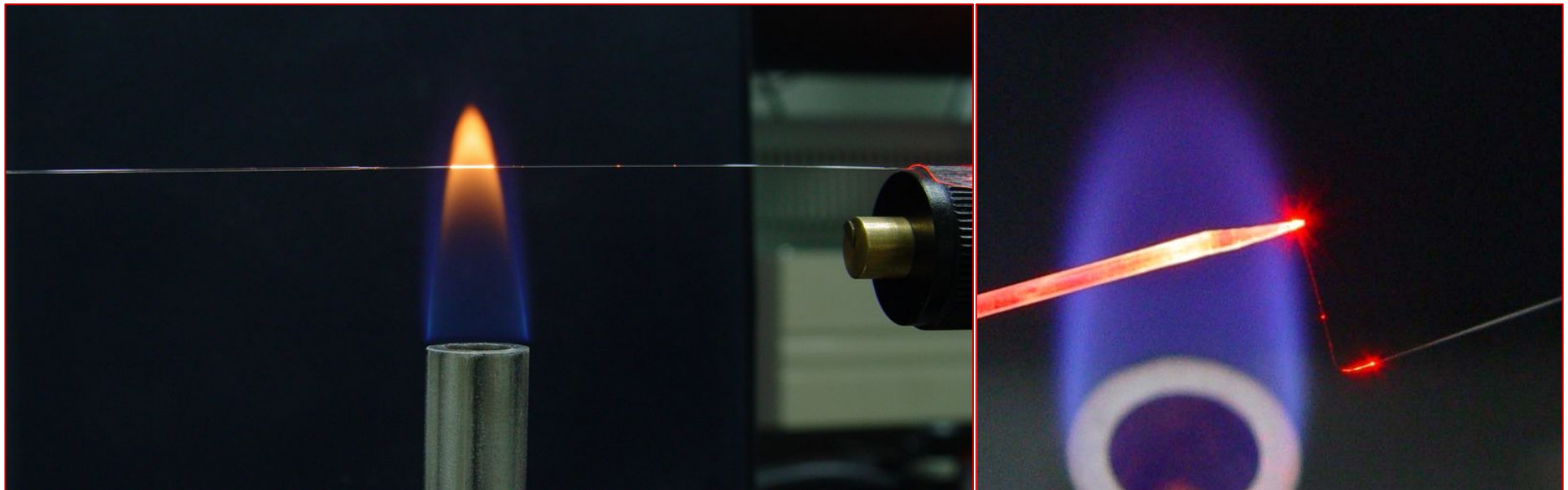

Taper drawing glass fibers to diameter $< 1 \mu\text{m}$

F. P. Payne et al., *SPIE* 1504, 165 (1991)

J. Bures et al., *J. Opt. Soc. Am. A* **16**, 1992 (1999)

L. Tong et al., *Nature* **426**, 816 (2003) 30

...

1. Fabrication of Microfibers

1.1 How to fabricate a microfiber?

Movie 1-1: Taper drawing a glass fiber heated by a flame

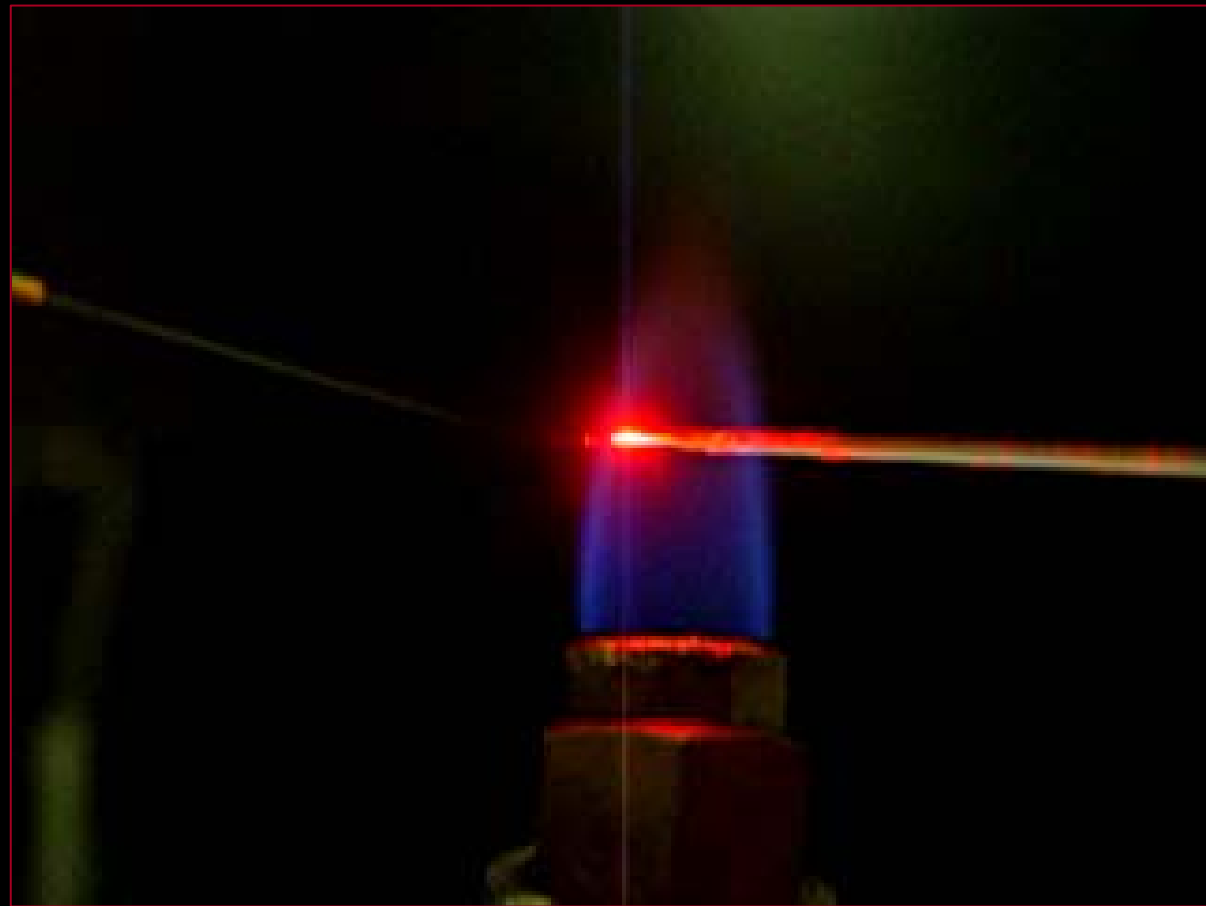

1. Fabrication of Microfibers

1.1 How to fabricate a microfiber?

Top-down approach

Physical drawing microfibers from

- glass fibers
- bulk glasses

x100

200 μm

1.00kV

6mm

1. Fabrication of Microfibers

SEM
images

Silica fibers

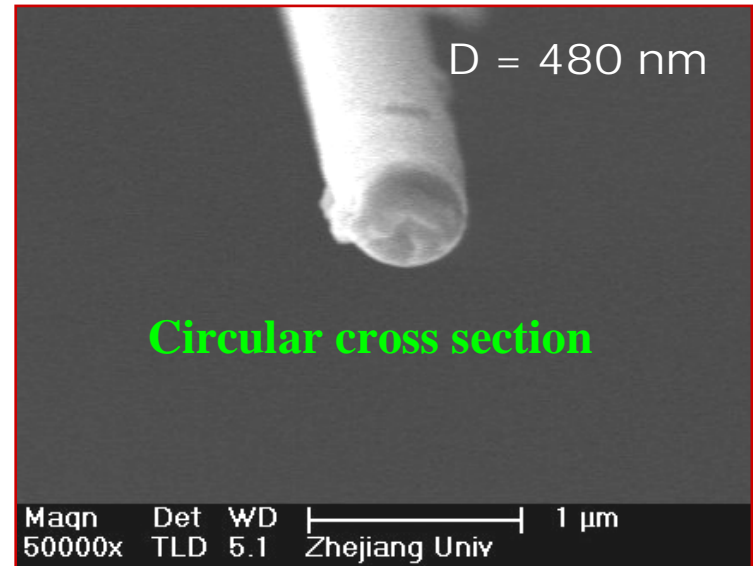
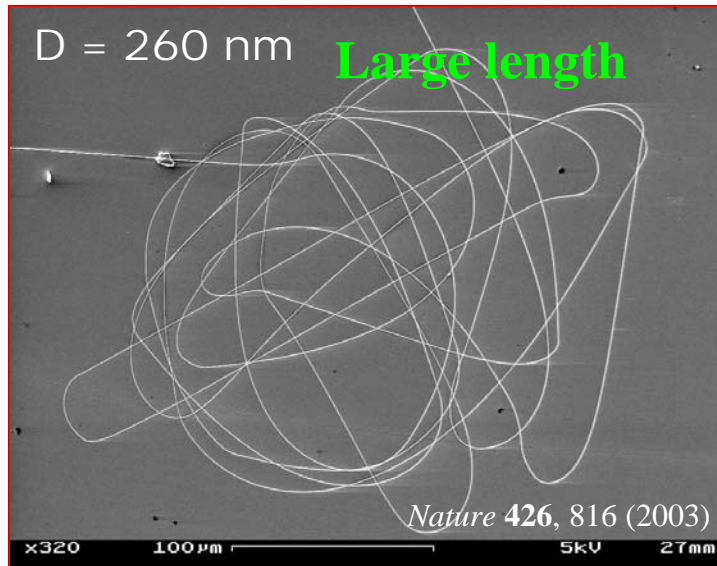
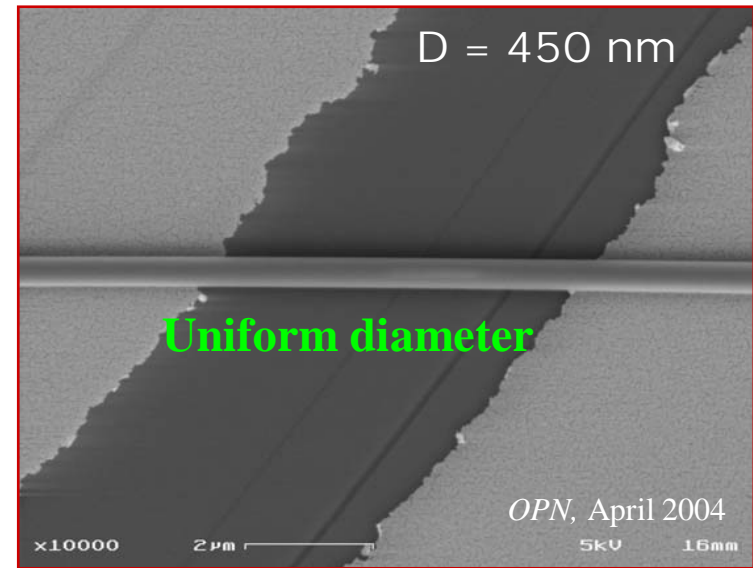
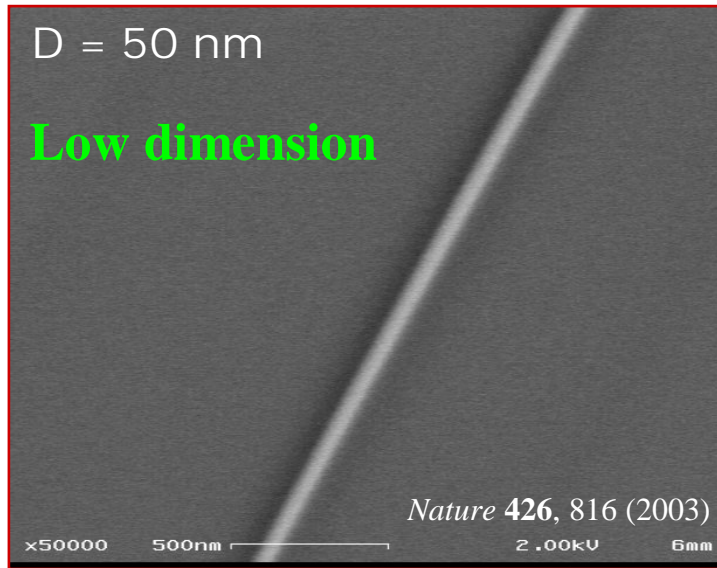

1. Fabrication of Microfibers

1.1 How to fabricate a microfiber?

Taper drawing of bulk glasses heated by flame or laser

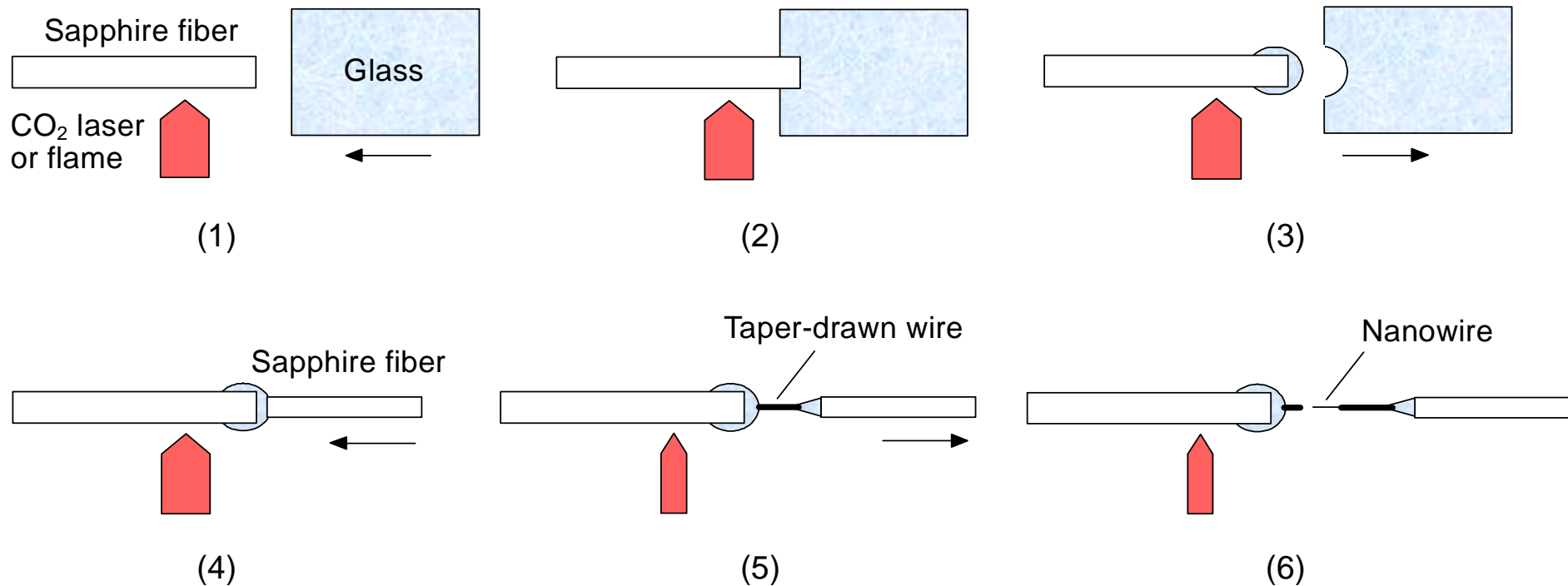

1. Fabrication of Microfibers

SEM images

Other materials a, e: tellurite b: silicate c, d, f: phosphate

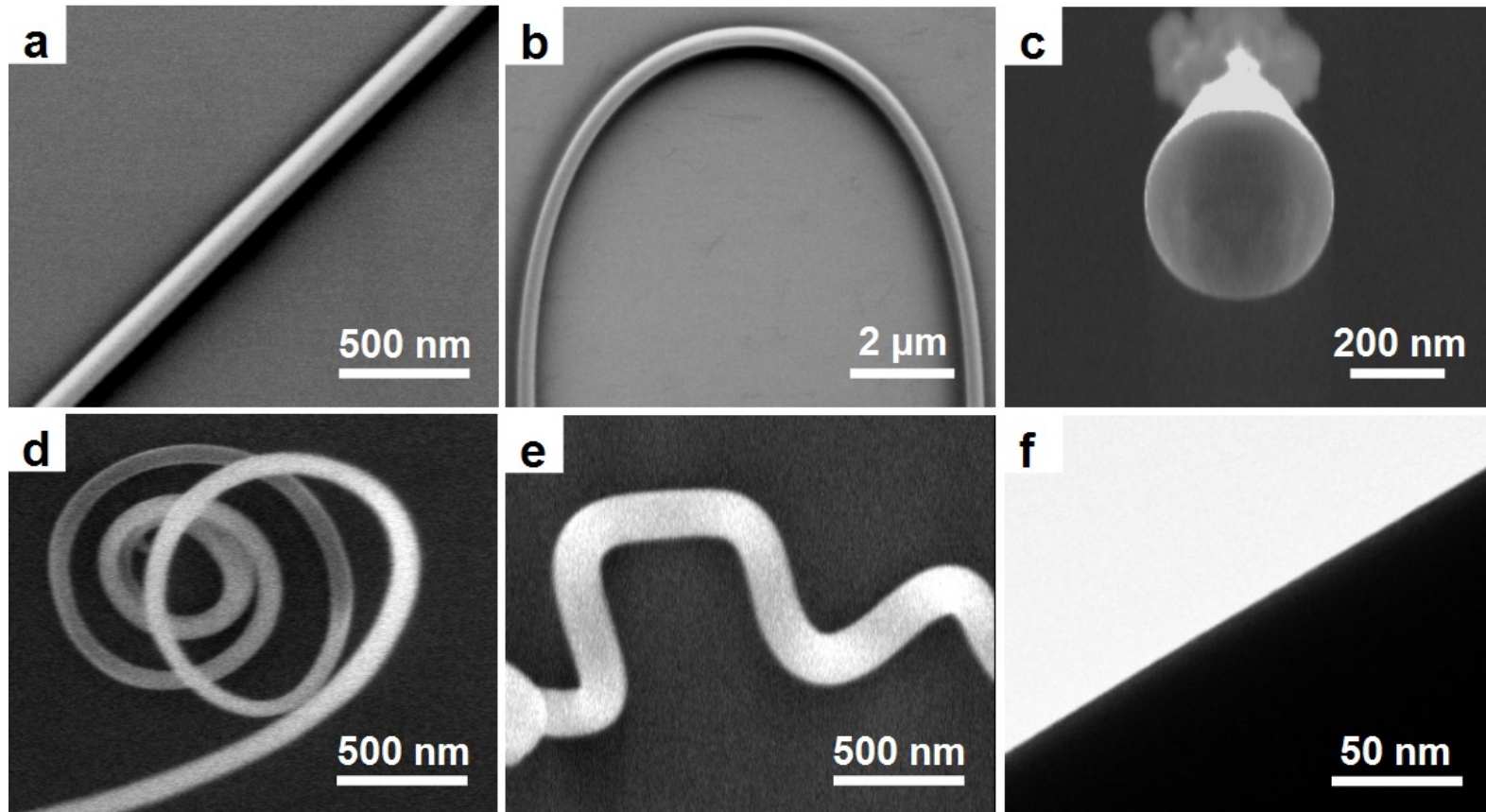

55

1. Fabrication of Microfibers

TEM images

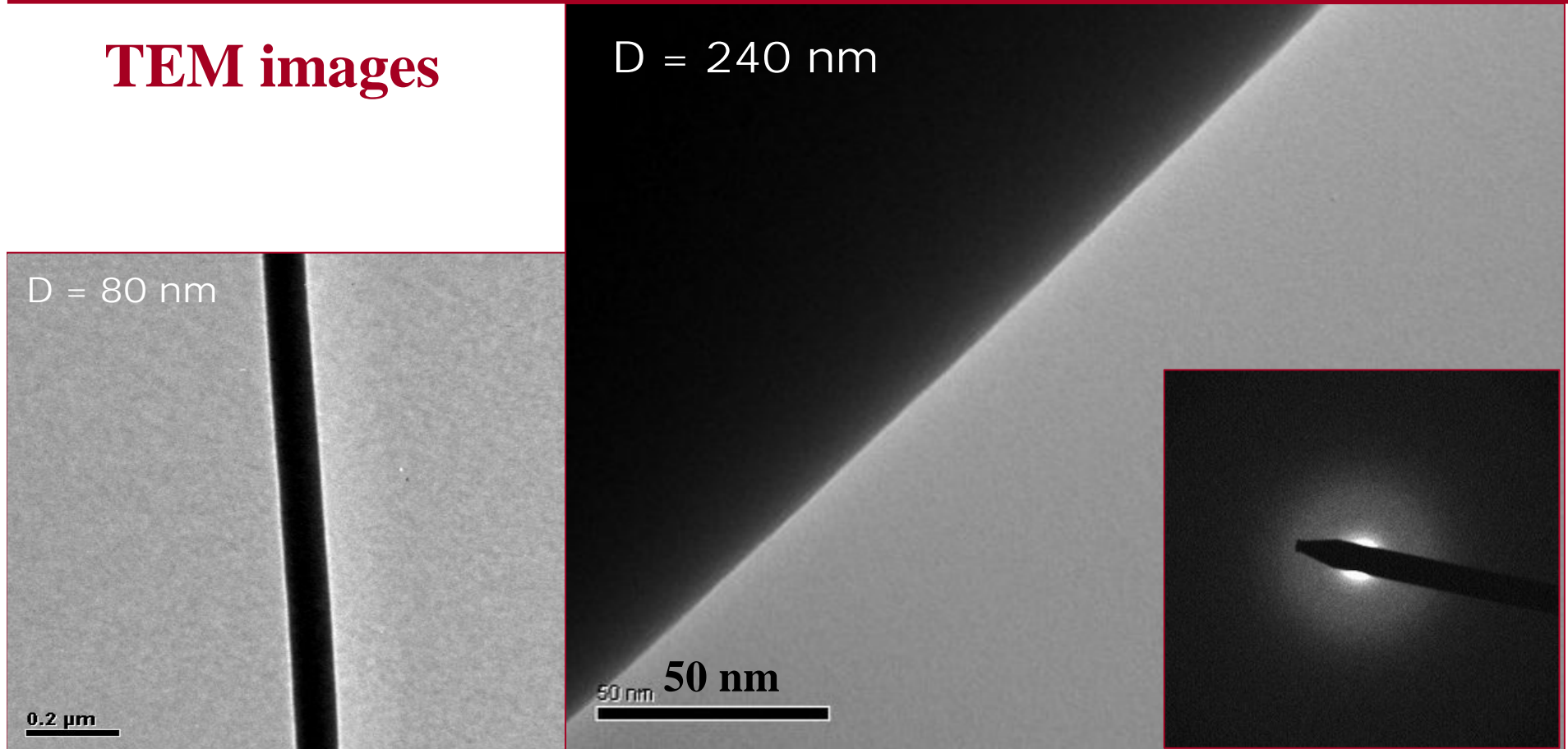

Very smooth surface with sidewall roughness (RMS) lower than 0.3 nm

➡ Favorite for low-loss optical wave guiding

1. Fabrication of Microfibers

1.2 Micromanipulation

Tailoring through micro/nanomanipulation

- **Cut**

Bend-to-fracture approach to cut fibers with flat endfaces

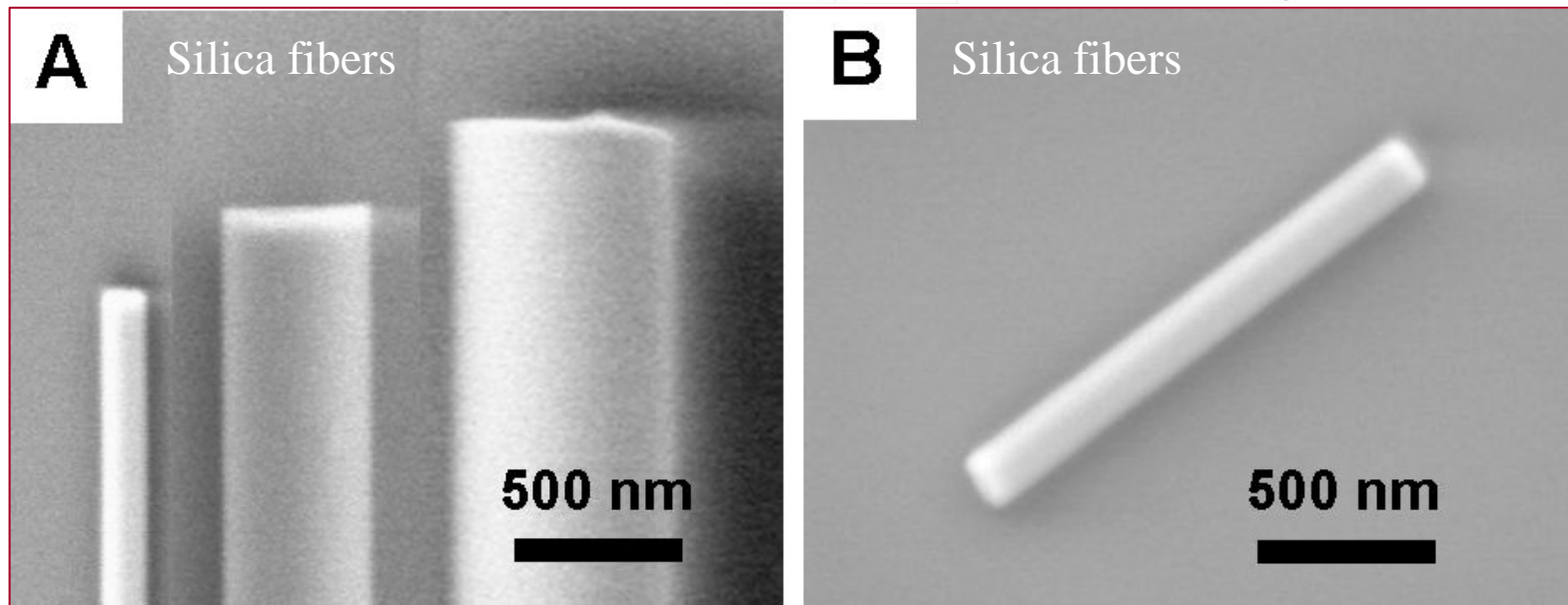
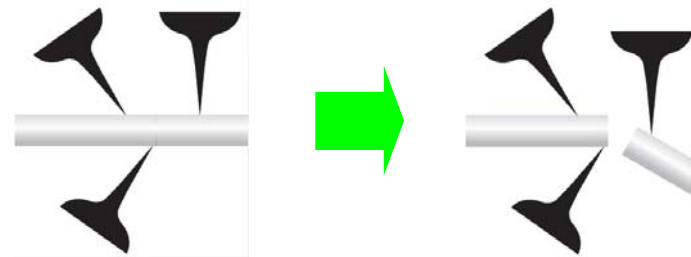

1. Fabrication of Microfibers

1.2 Micromanipulation

Tailoring through micro/nanomanipulation

- **Plastic bend**

Annealing-after-bending method

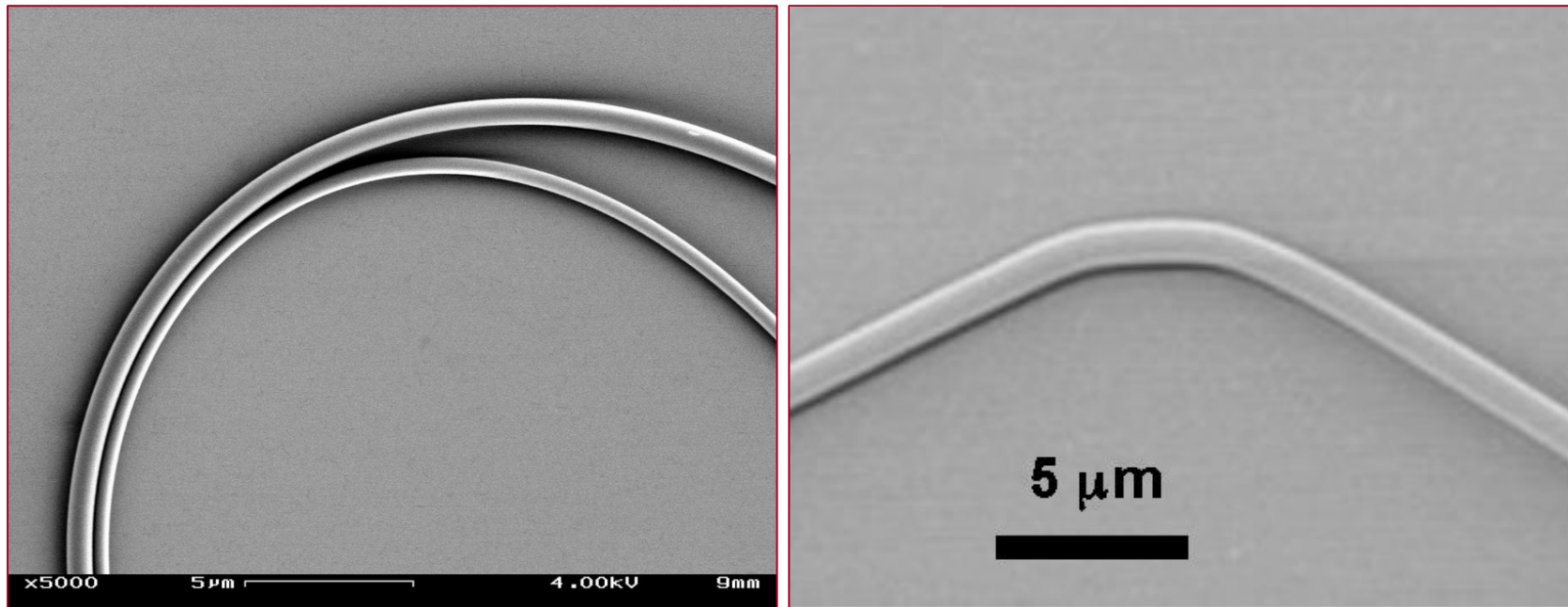

Silica fibers

1. Fabrication of Microfibers

1.2 Micromanipulation

Tailoring through micro/nanomanipulation

- **Twist**

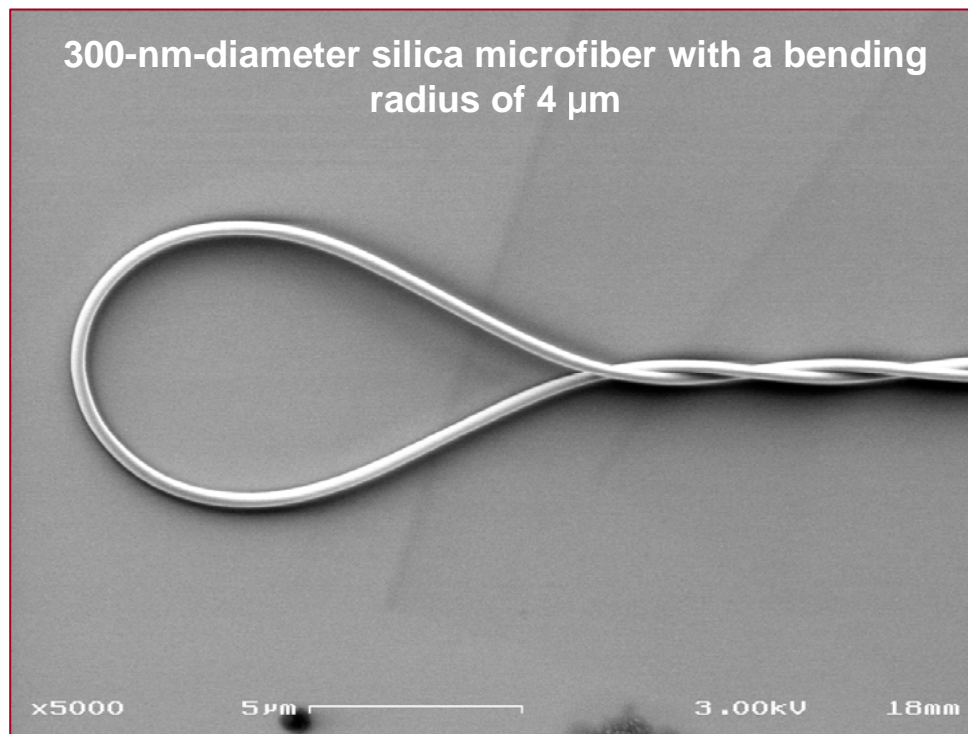

**Mechanically
robust & flexible**



**Critical for practical
applications**

Typical tensile strength > 5 GPa (@ RT)

Outline

- Introduction

1. Fabrication

2. Optical Properties

3. Potentials and Applications

- Summary

2. Optical Properties

- Basic model

Perfect cylindrical symmetry



Helmholtz Equations

$$\begin{aligned}(\nabla^2 + n^2 k^2 - \beta^2) \vec{e} &= 0, \\ (\nabla^2 + n^2 k^2 - \beta^2) \vec{h} &= 0.\end{aligned}$$



Analytical solutions of guided modes supported by the fiber [1]

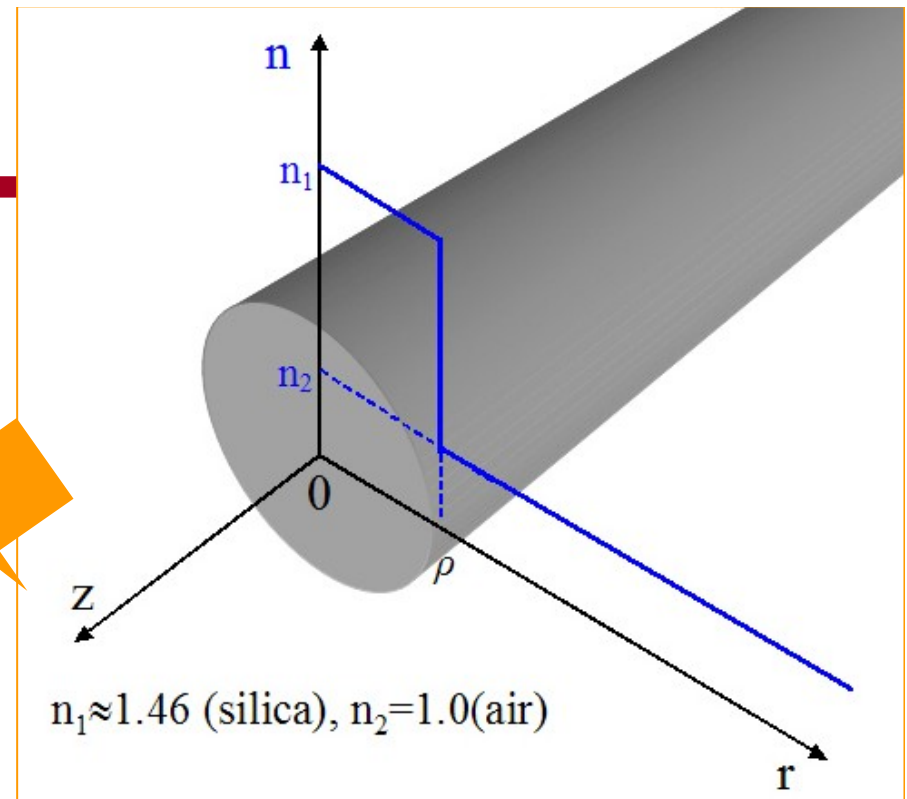

Boundary conditions

$$+ \quad n(r) = \begin{cases} n_1, & 0 \leq r < \rho \\ n_2, & \rho \leq r < \infty \end{cases}$$

HE_{vm}, EH_{vm}	$0 \leq r < \rho$	$\rho \leq r < \infty$
e_r	$-\frac{a_1 J_{v-1}(UR) + a_2 J_{v+1}(UR)}{J_v(U)} f_v(\phi)$	$-\frac{U}{W} \frac{a_1 K_{v-1}(WR) - a_2 K_{v+1}(WR)}{K_v(W)} f_v(\phi)$
e_ϕ	$-\frac{a_1 J_{v-1}(UR) - a_2 J_{v+1}(UR)}{J_v(U)} g_v(\phi)$	$-\frac{U}{W} \frac{a_1 K_{v-1}(WR) + a_2 K_{v+1}(WR)}{K_v(W)} g_v(\phi)$
e_z	$\frac{-iU}{\rho\beta} \frac{J_v(UR)}{J_v(U)} f_v(\phi)$	$\frac{-iU}{\rho\beta} \frac{K_v(WR)}{K_v(W)} f_v(\phi)$
h_r	$\left(\frac{\varepsilon_0}{\mu_0}\right)^{1/2} \frac{kn_1^2}{\beta} \frac{a_3 J_{v-1}(UR) - a_4 J_{v+1}(UR)}{J_v(U)} g_v(\phi)$	$\left(\frac{\varepsilon_0}{\mu_0}\right)^{1/2} \frac{kn_1^2}{\beta} \frac{U}{W} \frac{a_5 K_{v-1}(WR) + a_6 K_{v+1}(WR)}{K_v(W)} g_v(\phi)$
h_ϕ	$-\left(\frac{\varepsilon_0}{\mu_0}\right)^{1/2} \frac{kn_1^2}{\beta} \frac{a_3 J_{v-1}(UR) + a_4 J_{v+1}(UR)}{J_v(U)} f_v(\phi)$	$-\left(\frac{\varepsilon_0}{\mu_0}\right)^{1/2} \frac{kn_1^2}{\beta} \frac{U}{W} \frac{a_5 K_{v-1}(WR) - a_6 K_{v+1}(WR)}{K_v(W)} f_v(\phi)$
h_z	$-i \left(\frac{\varepsilon_0}{\mu_0}\right)^{1/2} \frac{UF_2}{k\rho} \frac{J_v(UR)}{J_v(U)} g_v(\phi)$	$-i \left(\frac{\varepsilon_0}{\mu_0}\right)^{1/2} \frac{UF_2}{k\rho} \frac{K_v(WR)}{K_v(W)} g_v(\phi)$
$f_v(\phi) = \begin{cases} \cos(v\phi) \\ \sin(v\phi) \end{cases}; \quad g_v(\phi) = \begin{cases} -\sin(v\phi) & \text{even} \\ \cos(v\phi) & \text{odd} \end{cases}$		$F_1 = \left(\frac{UW}{V}\right)^2 \frac{b_1 + (1-2\Delta)b_2}{v}; F_2 = \left(\frac{V}{UW}\right)^2 \frac{v}{b_1 + b_2}$
$a_1 = \frac{(F_2 - 1)}{2}; a_3 = \frac{(F_1 - 1)}{2}; a_5 = \frac{(F_1 - 1 + 2\Delta)}{2}$		$b_1 = \frac{1}{2U} \left\{ \frac{J_{v-1}(U)}{J_v(U)} - \frac{J_{v+1}(U)}{J_v(U)} \right\}$
$a_2 = \frac{(F_2 + 1)}{2}; a_4 = \frac{(F_1 + 1)}{2}; a_6 = \frac{(F_1 + 1 - 2\Delta)}{2}$		$b_2 = -\frac{1}{2W} \left\{ \frac{K_{v-1}(W)}{K_v(W)} + \frac{K_{v+1}(W)}{K_v(W)} \right\} \quad 42$

TE_{0m}	$0 \leq r < \rho$	$\rho \leq r < \infty$
e_ϕ	$-\frac{J_1(UR)}{J_1(U)}$	$-\frac{K_1(WR)}{K_1(W)}$
h_r	$\left(\frac{\epsilon_0}{\mu_0}\right)^{\frac{1}{2}} \frac{\beta J_1(UR)}{k J_1(U)}$	$\left(\frac{\epsilon_0}{\mu_0}\right)^{\frac{1}{2}} \frac{\beta K_1(WR)}{k K_1(W)}$
h_z	$i\left(\frac{\epsilon_0}{\mu_0}\right)^{\frac{1}{2}} \frac{U J_0(UR)}{k\rho J_1(U)}$	$-i\left(\frac{\epsilon_0}{\mu_0}\right)^{\frac{1}{2}} \frac{W K_0(WR)}{k\rho K_1(W)}$
$e_r = e_z = h_\phi = 0$		
TM_{0m}	$0 \leq r < \rho$	$\rho \leq r < \infty$
e_r	$\frac{J_1(UR)}{J_1(U)}$	$\frac{n_1^2 K_1(WR)}{n_2^2 K_1(W)}$
e_z	$\frac{iU J_0(UR)}{\rho\beta J_1(U)}$	$\frac{-in_1^2 W K_0(WR)}{n_2^2 \rho\beta K_1(W)}$
h_ϕ	$\left(\frac{\epsilon_0}{\mu_0}\right)^{\frac{1}{2}} \frac{kn_1^2 J_1(UR)}{\beta J_1(U)}$	$\left(\frac{\epsilon_0}{\mu_0}\right)^{\frac{1}{2}} \frac{kn_1^2 K_1(WR)}{\beta K_1(W)}$
$e_\phi = h_r = h_z = 0$		

2. Optical Properties

2.1 Basic model

Solve the eigenvalue equations numerically



$$\begin{array}{l} HE_{vm} \\ EH_{vm} \end{array} \left\{ \frac{J'_v(U)}{UJ'_v(U)} + \frac{K'_v(W)}{WK'_v(W)} \right\} \left\{ \frac{J'_v(U)}{UJ'_v(U)} + \frac{n_2^2 K'_v(W)}{n_1^2 WK'_v(W)} \right\} = \left(\frac{v\beta}{kn_1} \right)^2 \left(\frac{V}{UW} \right)^4$$

$$TE_{0m} \quad \frac{J_1(U)}{UJ_0(U)} + \frac{K_1(W)}{WK_0(W)} = 0$$

$$TM_{0m} \quad \frac{n_1^2 J_1(U)}{UJ_0(U)} + \frac{n_2^2 K_1(W)}{WK_0(W)} = 0$$

2. Optical Properties

- Basic model

Propagation constants (β)

Air-clad silica
microfibers
Wavelength: 633 nm

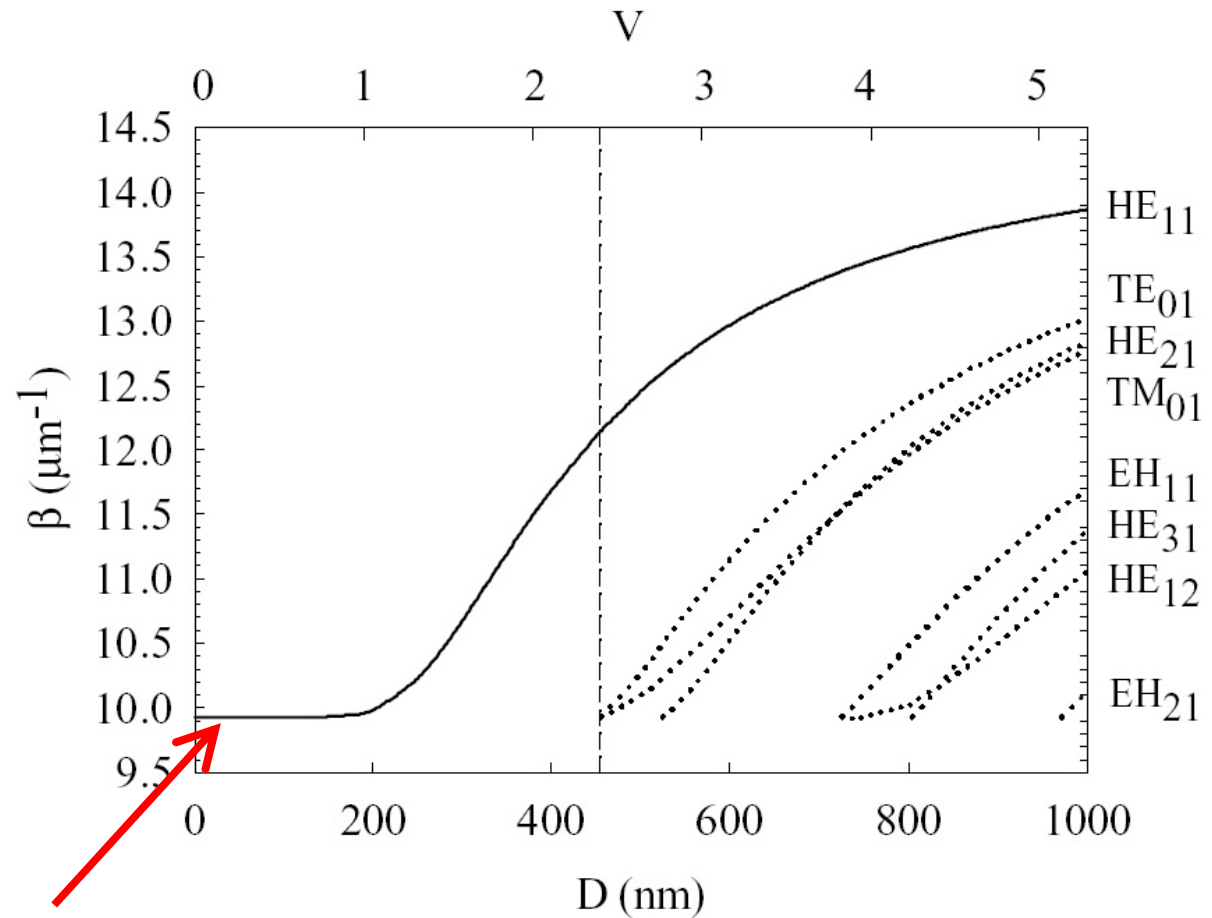

no cutoff of the fundamental modes

2. Optical Properties

• Single-mode condition

$$V = \pi \cdot \frac{D}{\lambda_0} \cdot (n_1^2 - n_2^2)^{1/2} \approx 2.405$$

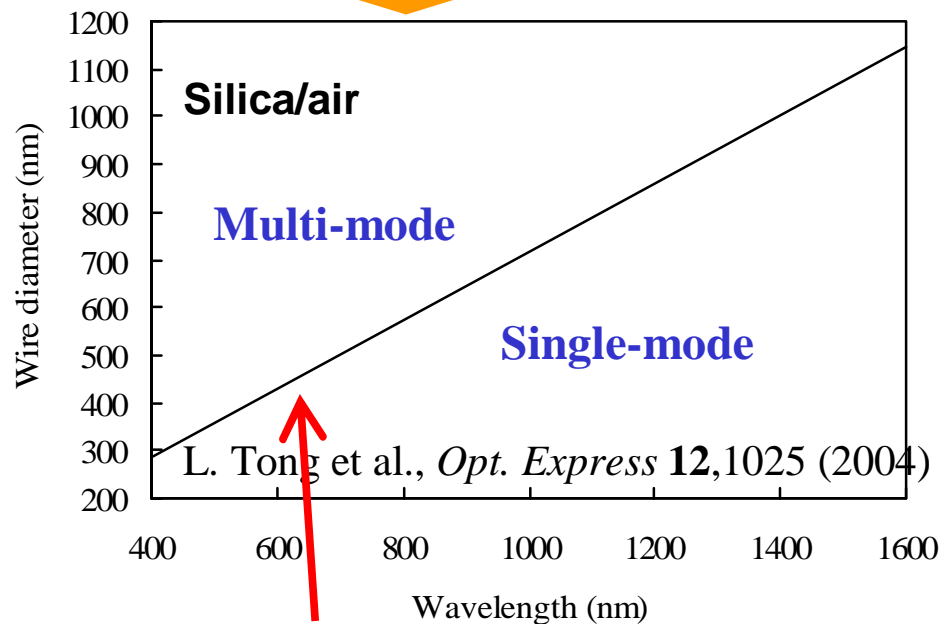

The shorter the wavelength

β for HE_{11} mode of several glass nanofibers

L. Tong et al., *Opt. Express* **14**, 82 (2006)

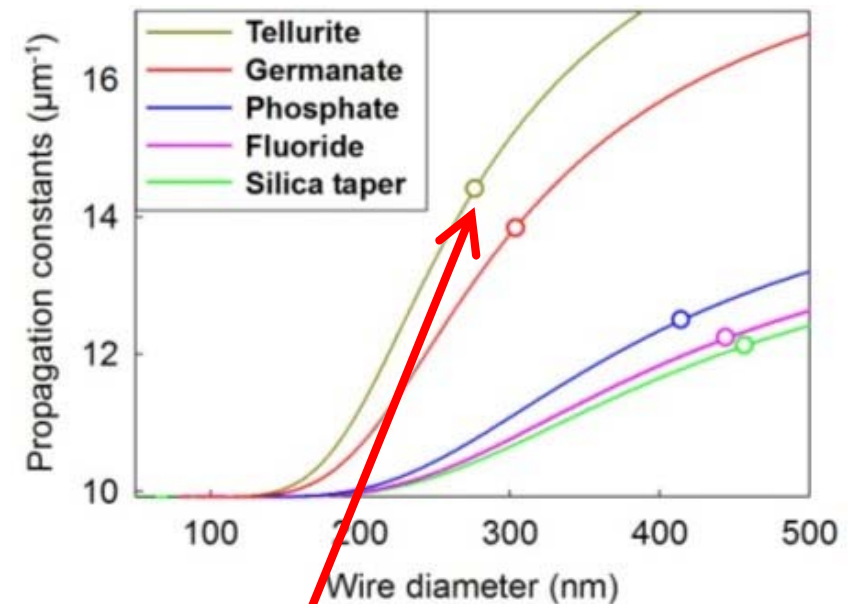

the higher the refractive index

the smaller the single-mode cutoff diameter

2. Optical Properties

- Electric fields of HE_{11} mode

For the fundamental mode (HE_{11})

Eigenvalue equations

$$\left\{ \frac{J_1'(U)}{UJ_1(U)} + \frac{K_1'(W)}{WK_1(W)} \right\} \left\{ \frac{J_1'(U)}{UJ_1(U)} + \frac{n_2^2 K_1'(W)}{n_1^2 WK_1(W)} \right\} = \left(\frac{\beta}{kn_1} \right)^2 \left(\frac{V}{UW} \right)^4$$



Solve β numerically



Electromagnetic fields $\begin{cases} \vec{E}(r, \phi, z) = (e_r \hat{r} + e_\phi \hat{\phi} + e_z \hat{z}) e^{i\beta z} e^{i\omega t}, \\ \vec{H}(r, \phi, z) = (h_r \hat{r} + h_\phi \hat{\phi} + h_z \hat{z}) e^{i\beta z} e^{i\omega t} \end{cases}$

2. Optical Properties

2.3 Electric fields of HE_{11} mode

For the fundamental mode (HE_{11})

Normalized electric fields in a air-clad silica fiber operated at 633-nm wavelength

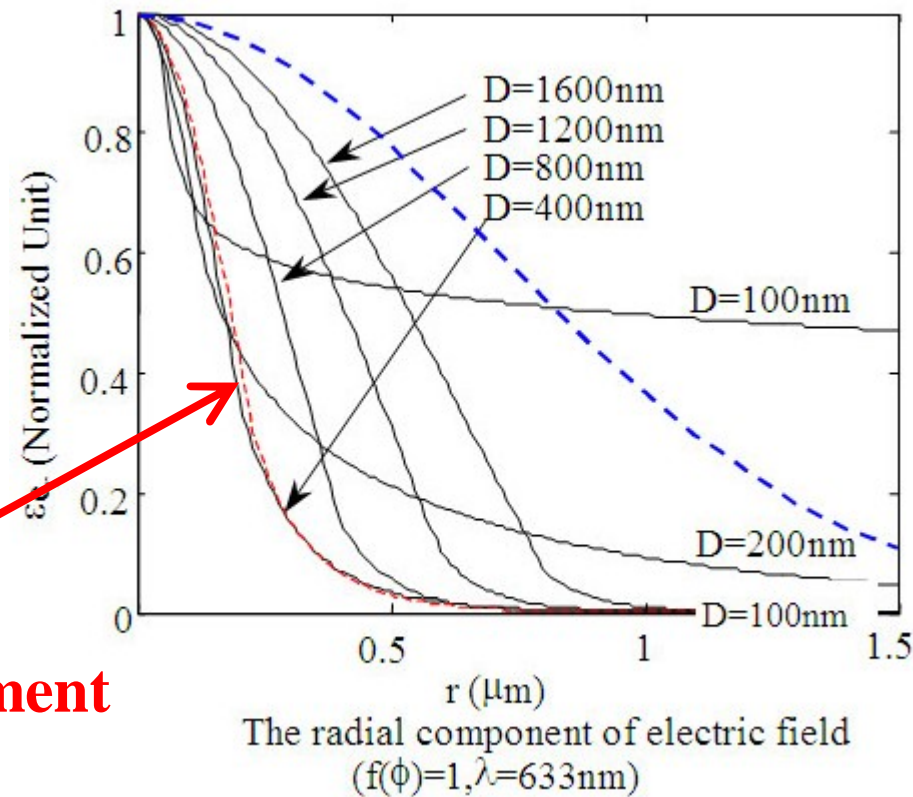

Tight confinement

For the fundamental mode (HE_{11})

Normalized electric fields in a air-clad silica fiber operated at 633-nm wavelength

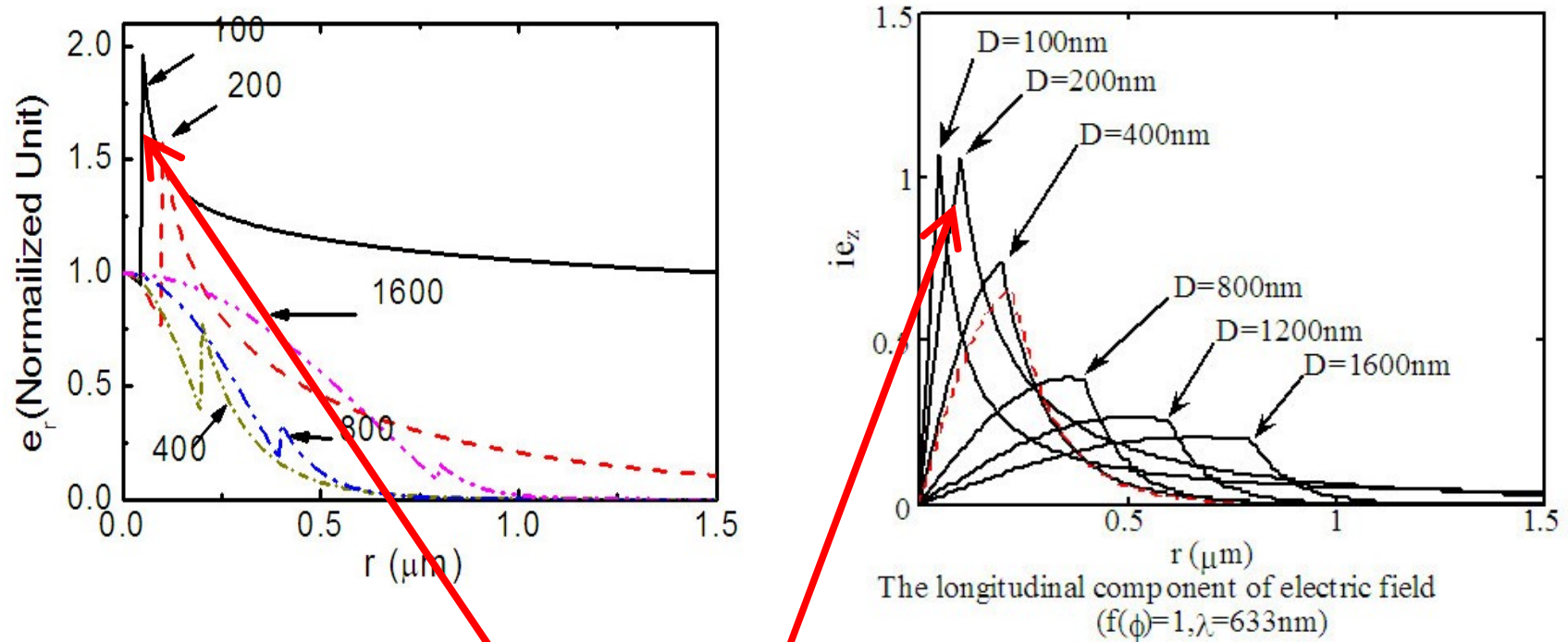

**On the surface, x- and z-component \rightarrow Maximum
 \rightarrow field enhancement on surface**

e.g., when a 1-mW 780-nm-wavelength light sent into a 340-nm-diameter silica nanofiber, it generate a $2\text{kW}/\text{mm}^2$ power density on the nanofiber surface.

2. Optical Properties

- Evanescent field of HE₁₁ mode

Z-components of Poynting vector

$$S_z = \begin{cases} \frac{|a|^2}{2} \left(\frac{\epsilon_0}{\mu_0} \right)^{1/2} \frac{kn_1^2}{\beta J_1^2(U)} \left\{ a_1 a_3 J_0^2(UR) + a_2 a_4 J_2^2(UR) + \frac{1-F_1 F_2}{2} J_0(UR) J_2(UR) \cos(2\phi) \right\}, & \text{core} \\ \frac{|a|^2}{2} \left(\frac{\epsilon_0}{\mu_0} \right)^{1/2} \frac{kn_1^2}{\beta K_1^2(W)} \frac{U^2}{W^2} \left\{ a_1 a_5 K_0^2(WR) + a_2 a_6 K_2^2(WR) - \frac{1-2\Delta-F_1 F_2}{2} K_0(WR) K_2(WR) \cos(2\phi) \right\}, & \text{cladding} \end{cases}$$

Fractional power inside the core

$$\eta = \frac{P_1}{P_1 + P_2} \quad \text{where} \quad P_1 = \int_0^a S_{z1} dA, \quad P_2 = \int_a^\infty S_{z2} dA,$$

$$dA = \rho^2 R \cdot dR \cdot d\phi = r \cdot dr \cdot d\phi.$$

2. Optical Properties

- Evanescent field of HE_{11} mode

Fractional power inside the core

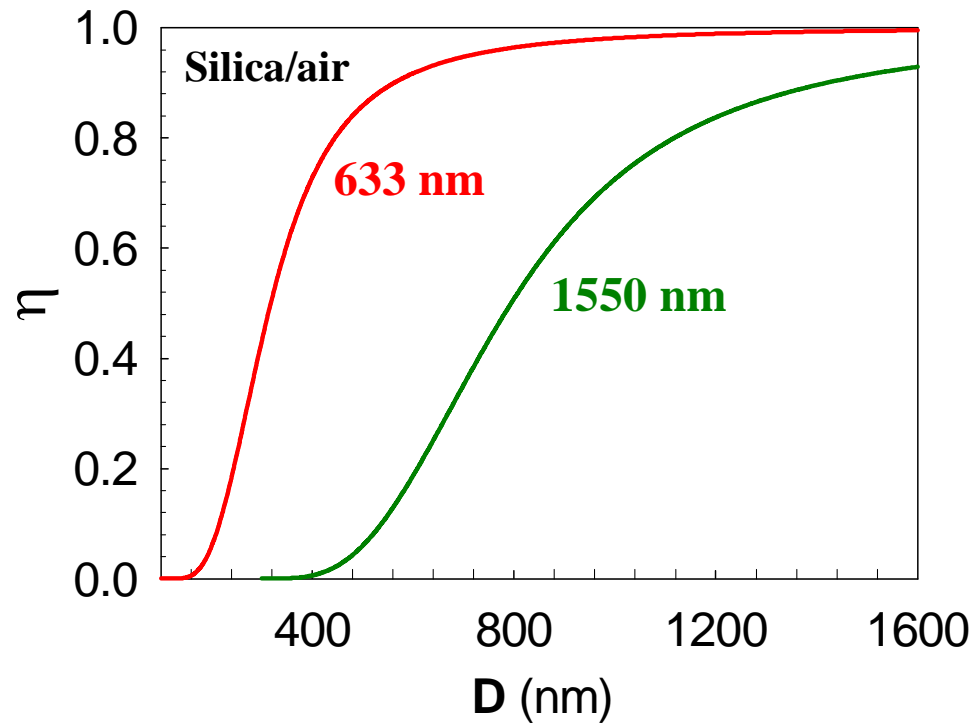

2. Optical Properties

- Evanescent field of HE_{11} mode

Fractional power inside the core

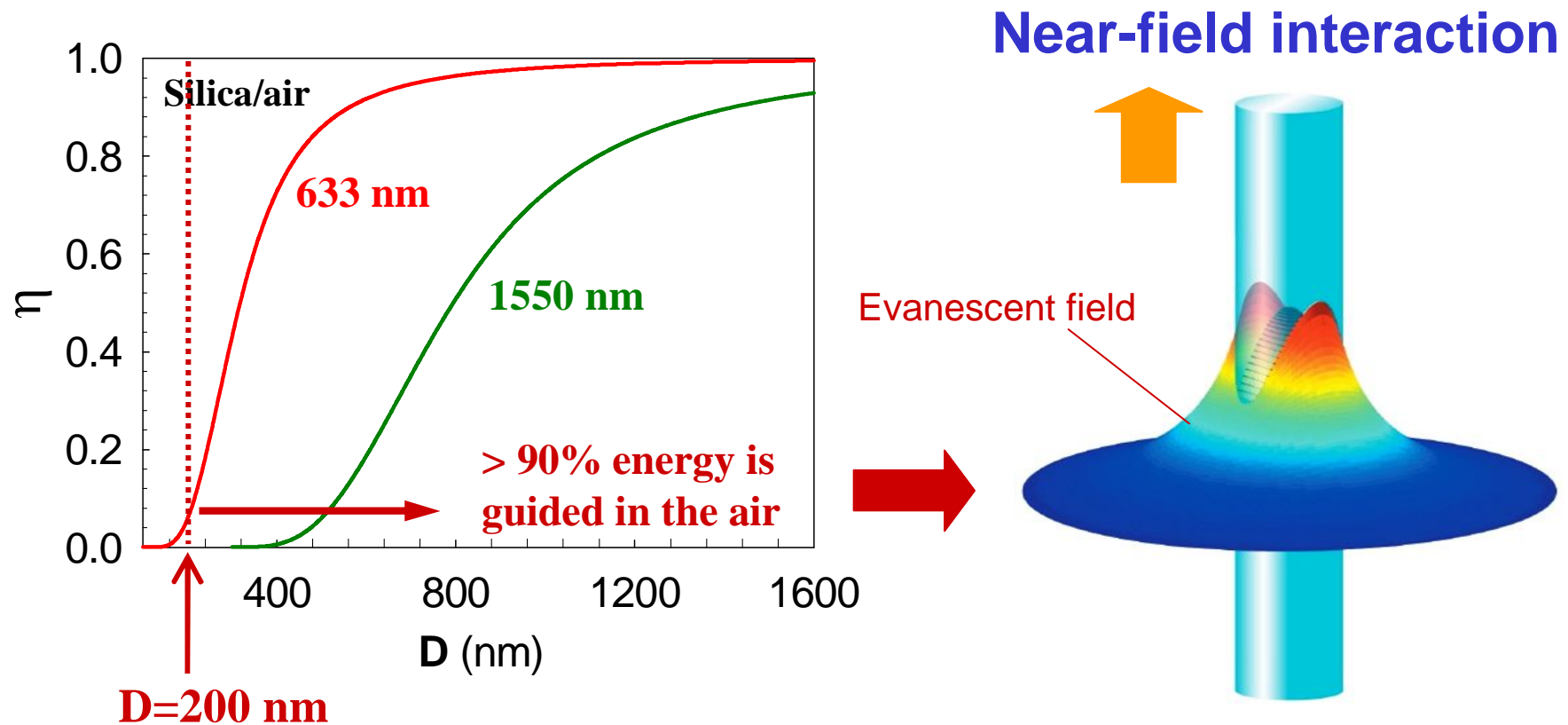

2. Optical Properties

- Optical confinement of HE_{11} mode

Effective Diameter: Mode area for optical confinement of 86.5%

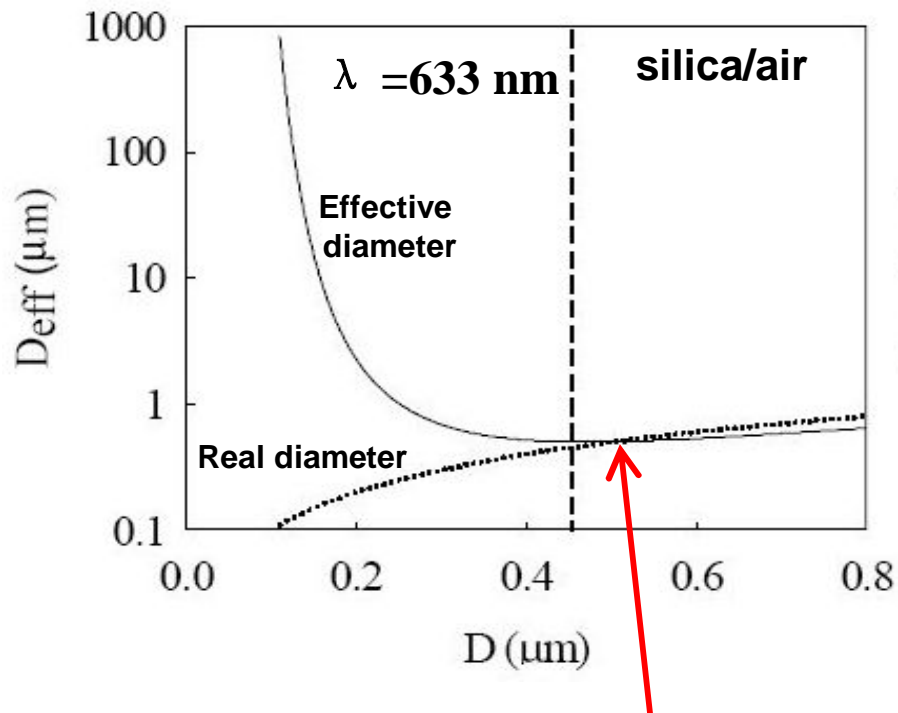

Minimum usable Effective Diameter ~ 500 nm

2. Optical Properties

- Optical confinement of HE_{11} mode

Effective Diameter: Mode area for optical confinement of 86.5%

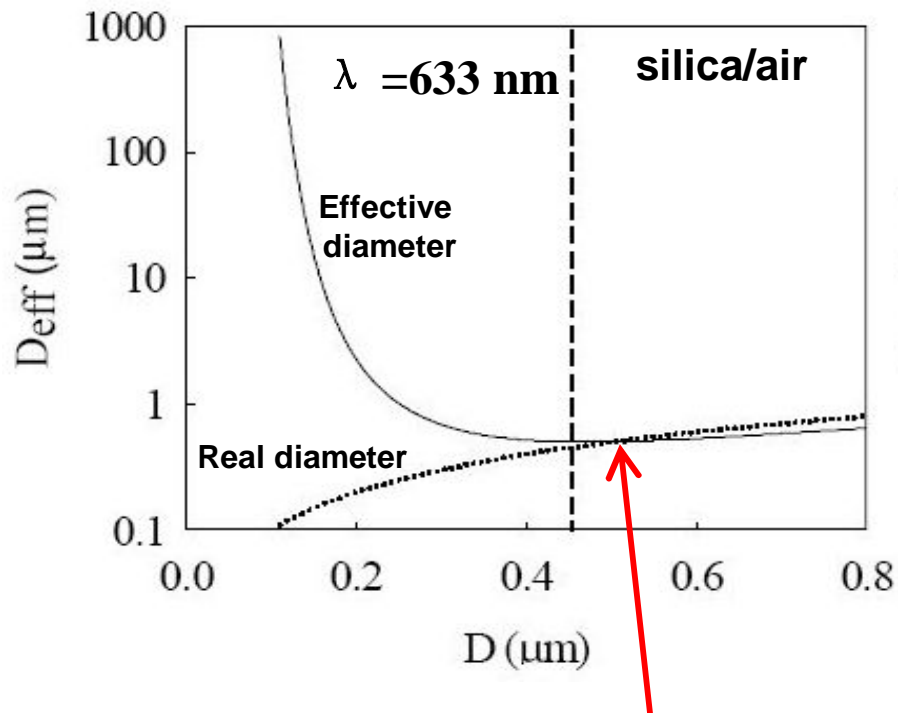

Minimum usable Effective Diameter ~ 510 nm

Small mode area



Nonlinear effects

2. Optical Properties

- Waveguide dispersion of HE_{11} mode

Waveguide dispersion in air-clad silica fibers

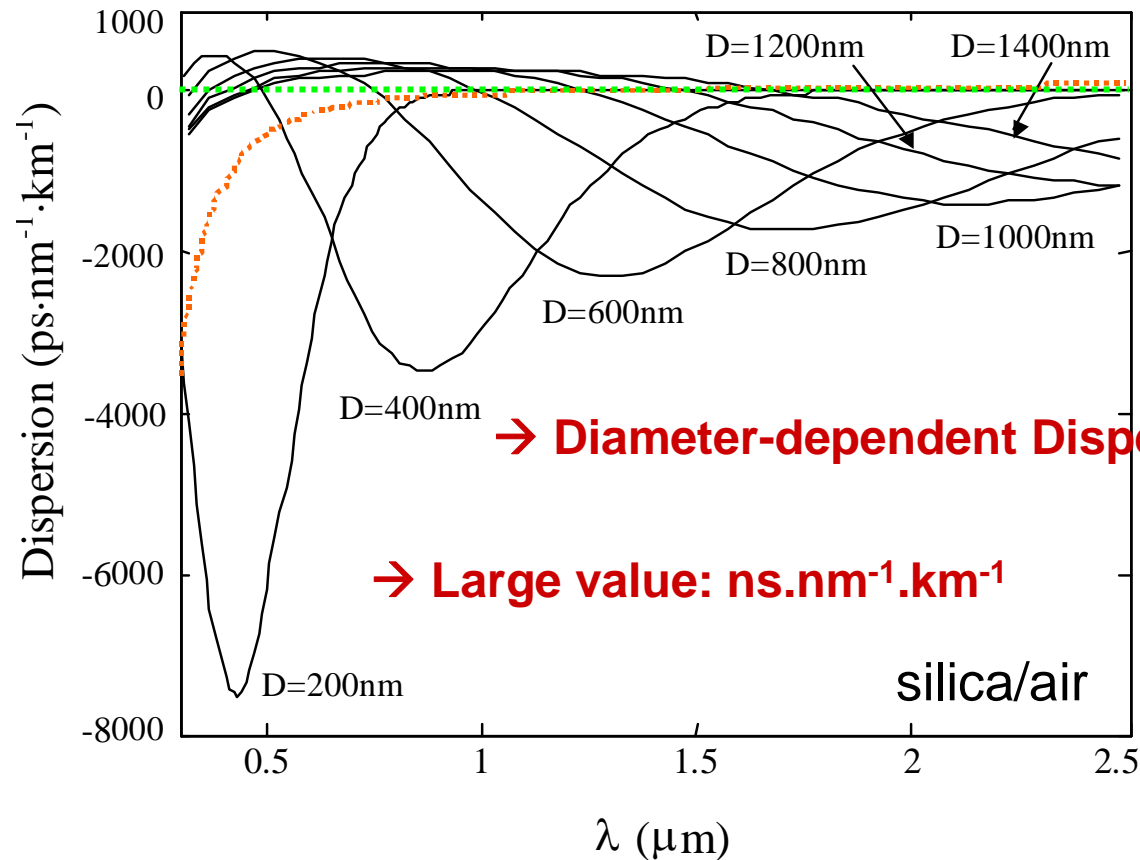

Nonlinear effects

2. Optical Properties

• Optical loss in real microfibers

Measured losses for single-mode glass fibers are typically < 0.1 dB/mm

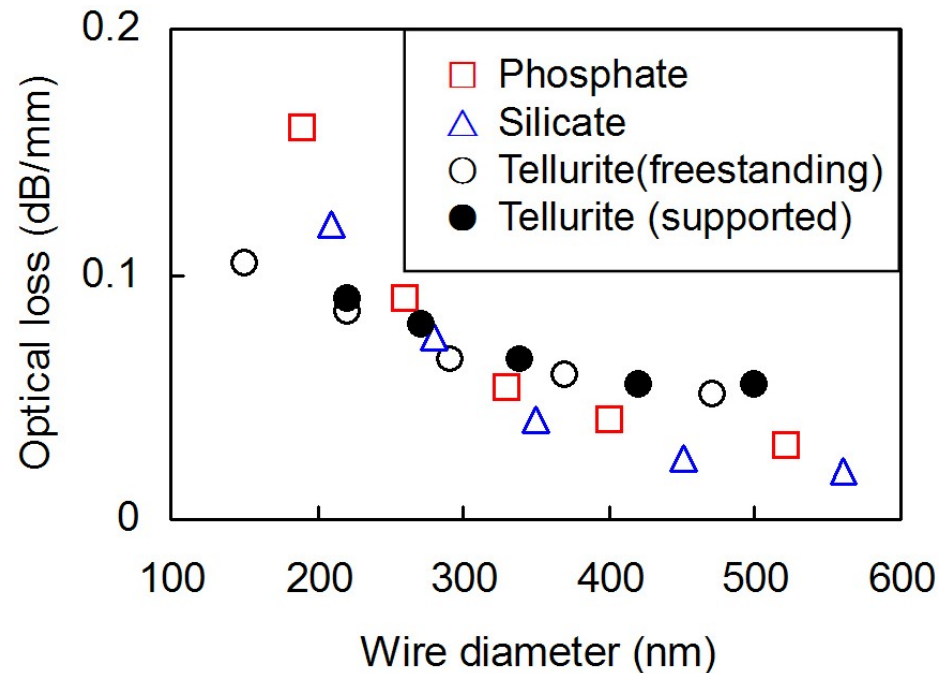

L. Tong et al., *Opt. Express* 14, 82 (2006)

Lower loss reported in silica fibers:

$\alpha \sim 0.01$ dB/mm [2]

[2] G. Brambilla et al., *Opt. Express* 12, 2258 (2004)



Lowest loss reported:

$\alpha \sim 1$ dB/m [3]

[3] S. G. Leon-Saval et al., *Opt. Express* 12, 2864 (2004)



Lower loss may be possible

$\alpha < 0.1$ dB/m

2. Optical Properties

- **Optical loss in real microfibers**

Bending loss

**High index contrast
between silica and air**



**Light can be guided through sharp bend
with low optical loss**

A

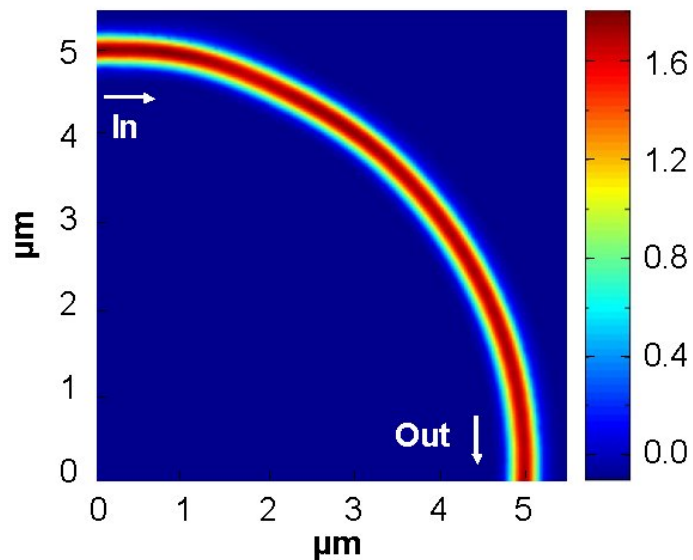

3D-FDTD simulations of the intensity of a 633-nm-wavelength light guided in 5- μm -radius-bend 450-nm-diameter silica fiber.

2. Optical Properties

- Optical loss in real microfibers

Bending loss

**High index contrast
between silica and air**



A

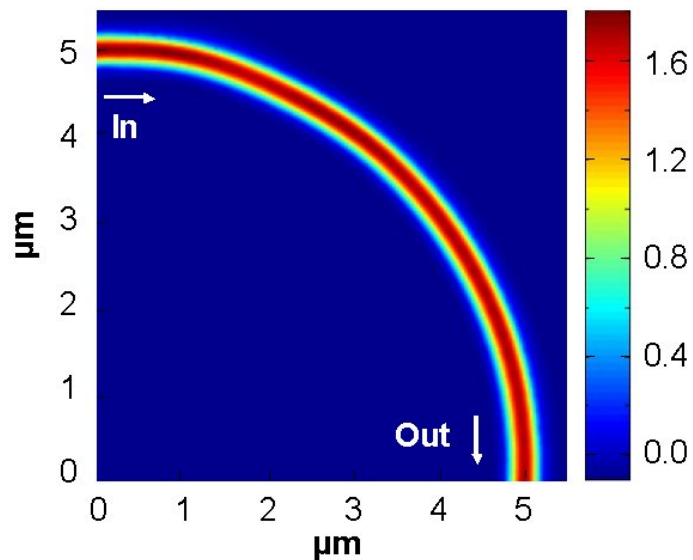

3D-FDTD simulations of the intensity of a 633-nm-wavelength light guided in 5- μm -radius-bend 450-nm-diameter silica fiber.

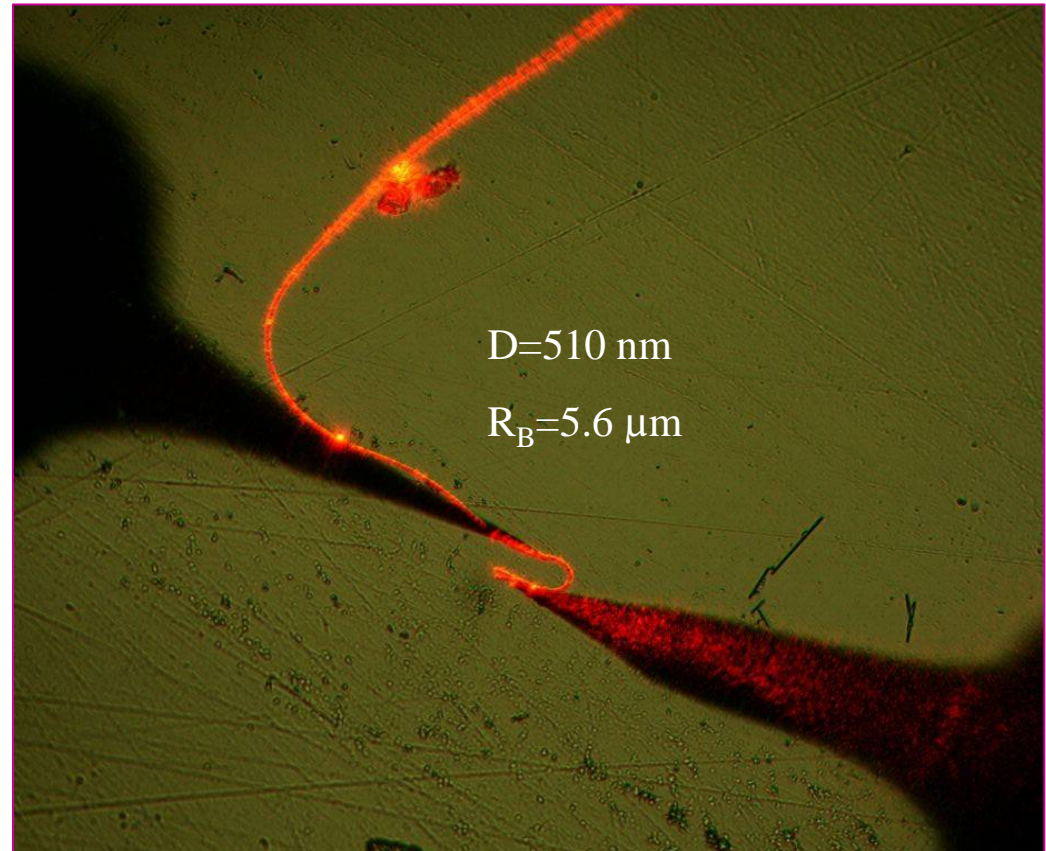

Optical microscope image of a 633-nm-wavelength light guided in 5.6- μm -radius-bend 510-nm-diameter silica fiber.

Bending loss

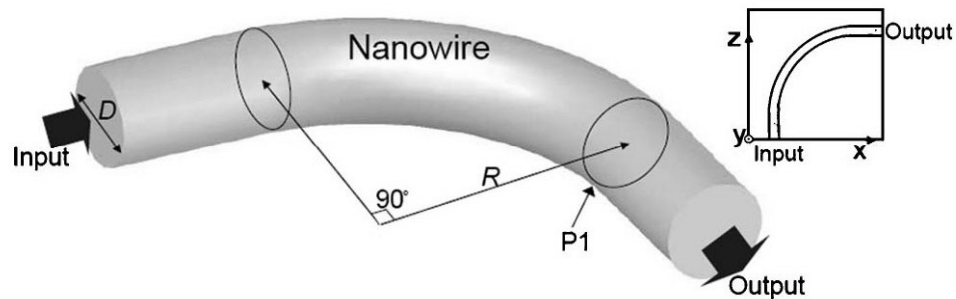

Fig. 1. Mathematical model for 3D-FDTD simulation of a circular 90° bent nanowire. Inset, topography profile of the bent nanowire.

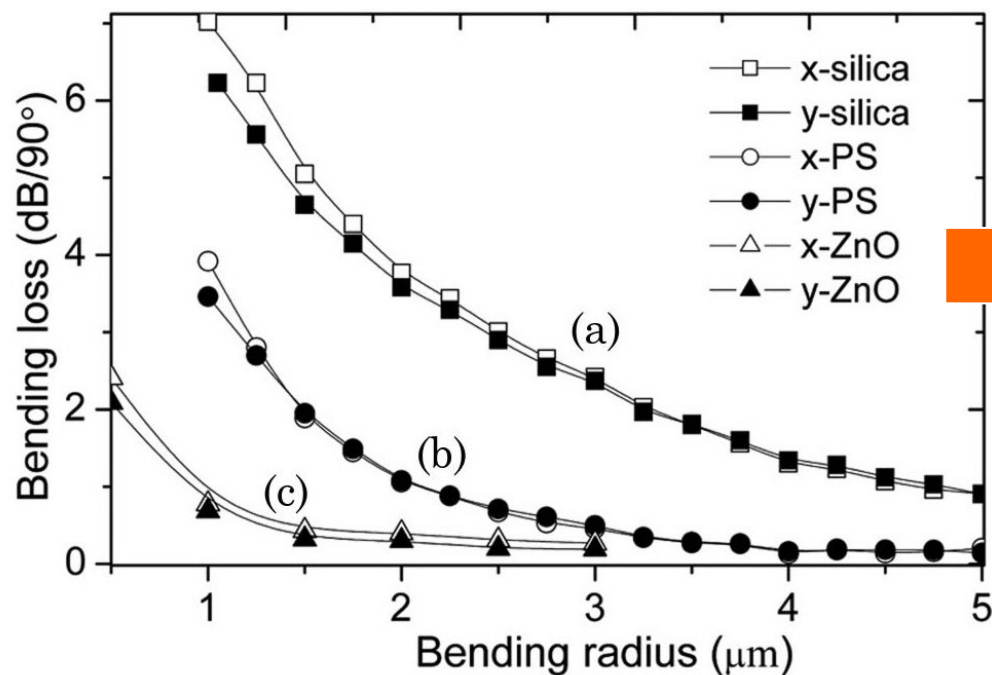

Fig. 3. Bending-radius-dependent bending losses of (a) a 350 nm diameter silica nanowire, (b) a 350 nm diameter PS nanowire, and (c) a 270 nm diameter ZnO nanowire with a 633 nm wavelength source.

3D-FDTD simulations

PS nanofiber ($n=1.59$)

633-nm wavelength

2- μm bending radius

Bending loss ~ 1 dB/90°

2. Optical Properties

■ What's New ?

Small

2. Optical Properties

■ What's New ?

Small



High Δn for SM \rightarrow
Sharper bend with
shorter optical length

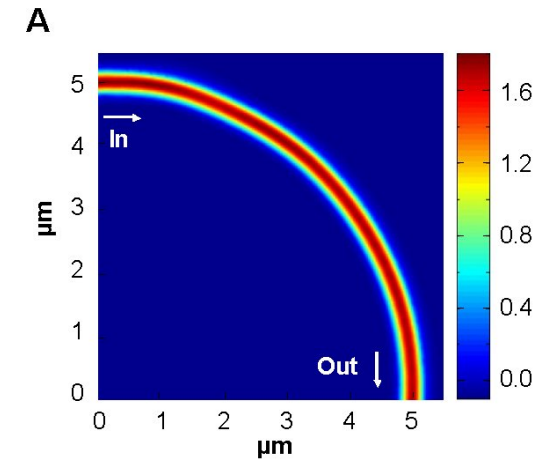

2. Optical Properties

■ What's New ?

Small

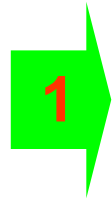

High Δn for SM \rightarrow
Sharper bend with
shorter optical length

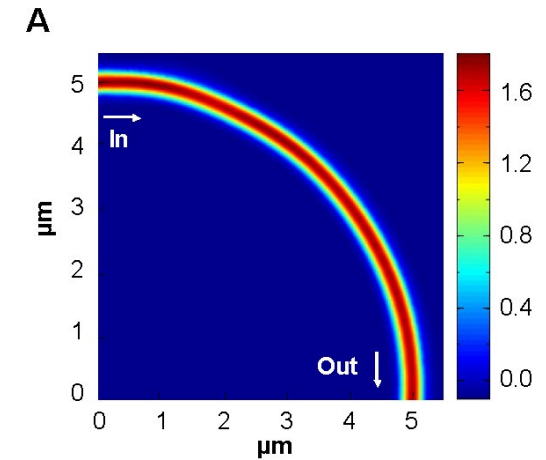

Light travels through with less time

e.g., consider the minimum allowable bending radius

SMF ~ 1 cm $\rightarrow \sim 30$ ps

Nanofiber ~ 10 μm NF $\rightarrow \sim 30$ fs 1000 times faster

2. Optical Properties

■ What's New ?

Small

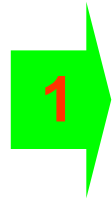

High Δn for SM \rightarrow
Sharper bend with
shorter optical length

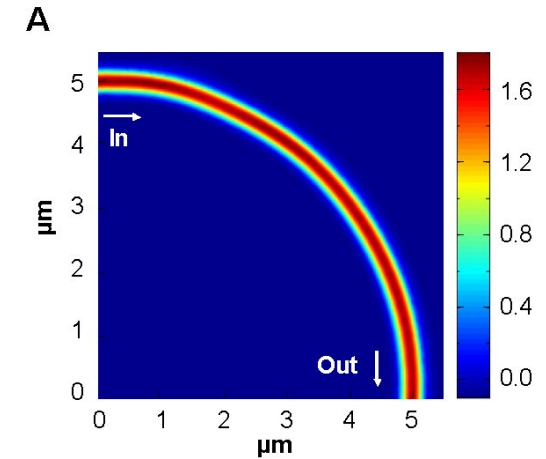

Light travels through with less time

e.g., consider the minimum allowable bending radius

SMF ~ 1 cm $\rightarrow \sim 30$ ps

Nanofiber ~ 10 μm NF $\rightarrow \sim 30$ fs 1000 times faster



Faster operation

2. Optical Properties

■ What's New ?

Small



Core diameter $<$ wavelength



High fraction of evanescent fields
Steep field gradient

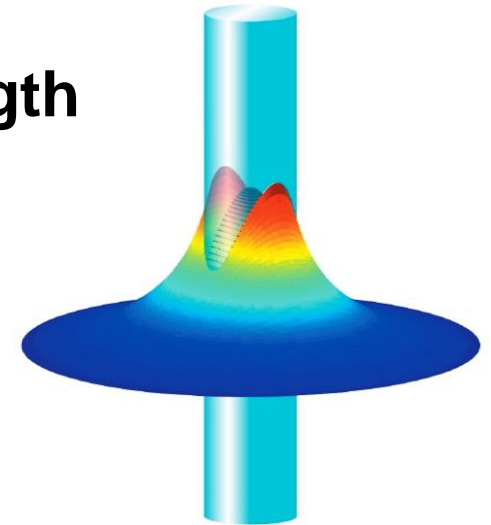

2. Optical Properties

■ What's New ?

Small



Core diameter $<$ wavelength



High fraction of evanescent fields
Steep field gradient



Stronger near-field
interaction



Higher-sensitivity
optical sensing

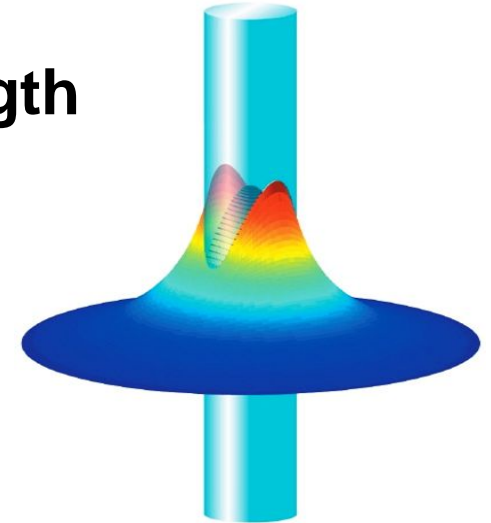

2. Optical Properties

■ What's New ?

Small

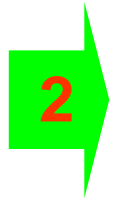

Core diameter $<$ wavelength



High fraction of evanescent fields
Steep field gradient

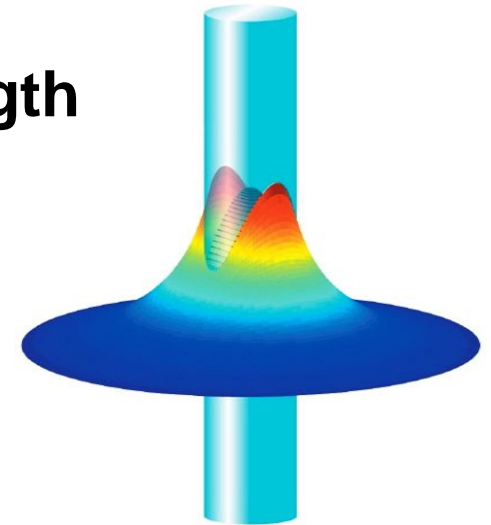

Stronger near-field
interaction



Larger optical
gradient force



Higher-sensitivity
optical sensing



Atom trapping and
waveguiding

2. Optical Properties

■ What's New ?

Small

3

Smaller mode area

e.g., SMF $\sim 100 \mu\text{m}^2$
Nanofiber $\sim 1 \mu\text{m}^2$

2. Optical Properties

■ What's New ?

Small

3

Smaller mode area

e.g., SMF ~ 100 μm^2
Nanofiber ~ 1 μm^2

Thinner Beam

Higher-sensitivity
optical sensing

2. Optical Properties

■ What's New ?

Small

3

Smaller mode area

e.g., SMF $\sim 100 \mu\text{m}^2$
Nanofiber $\sim 1 \mu\text{m}^2$

Thinner Beam

Higher effective
nonlinearity

Higher-sensitivity
optical sensing

Lower-threshold optical
nonlinear effects

2. Optical Properties

■ What's New ?

Small



Tight confinement with small mode area



Modify vacuum states around the nanofiber

2. Optical Properties

■ What's New ?

Small  Tight confinement with small mode area



Modify vacuum states around the nanofiber



Modify spontaneous
rate of an atom nearby

2. Optical Properties

■ What's New ?

Small  Tight confinement with small mode area



Modify vacuum states around the nanofiber



Modify spontaneous rate of an atom nearby



Couple distant atoms through the fiber

2. Optical Properties

■ What's New ?

Small



Extremely light in mass



e.g., Mass of a 200-nm-diameter 10-um-length nanofiber is
~ 10^{-15} kg / ~ 10 pN (in weight)
comparable to the pressure of light with power of 10 mW

2. Optical Properties

■ What's New ?

Small



Extremely light in mass



e.g., Mass of a 200-nm-diameter 10-um-length nanofiber is
~ 10^{-15} kg / ~ 10 pN (in weight)
comparable to the pressure of light with power of 10 mW



Feel the momentum of light guided through

2. Optical Properties

■ What's New ?

Small



Extremely light in mass



e.g., Mass of a 200-nm-diameter 10-um-length nanofiber is
~ 10^{-15} kg / ~ 10 pN (in weight)
comparable to the pressure of light with power of 10 mW



Feel the momentum of light guided through



Photon-momentum-
induced effect

2. Optical Properties

■ What's New ?

Small

5

Extremely light in mass

e.g., Mass of a 200-nm-diameter 10-um-length nanofiber is
~ 10^{-15} kg / ~ 10 pN (in weight)
comparable to the pressure of light with power of 10 mW

Feel the momentum of light guided through

Photon-momentum-
induced effect

Fundamental research
in photonics

2. Optical Properties

■ What's New ?

Small



More :

Large and manageable dispersion
Enhanced field intensity on surface
Low dimension for fast diffusion

...

100um

2. Optical Properties

■ What's New ?

Small

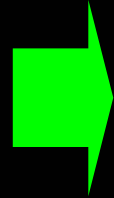

More :

Large and manageable dispersion
Enhanced field intensity on surface
Low dimension for fast diffusion

...

Shrink optical fibers

Plenty of New Opportunities

100um

Outline

- Introduction

1. Fabrication

2. Optical Properties

3. Potentials and Applications

- Summary

Outline

3. Potentials and Applications

(1) Near-Field Optics

(2) Plasmonics

(3) Nonlinear Optics

(4) Quantum Optics\Atom Optics

(5) Photon Momentum

Outline

3. Potentials and Applications

(1) Near-Field Optics

(2) Plasmonics

(3) Nonlinear Optics

(4) Quantum Optics\Atom Optics

(5) Photon Momentum

(1) Near-field Optics

2.1 Near-field coupling between two nanofibers

High fraction of evanescent field \rightarrow Strong near-field interaction

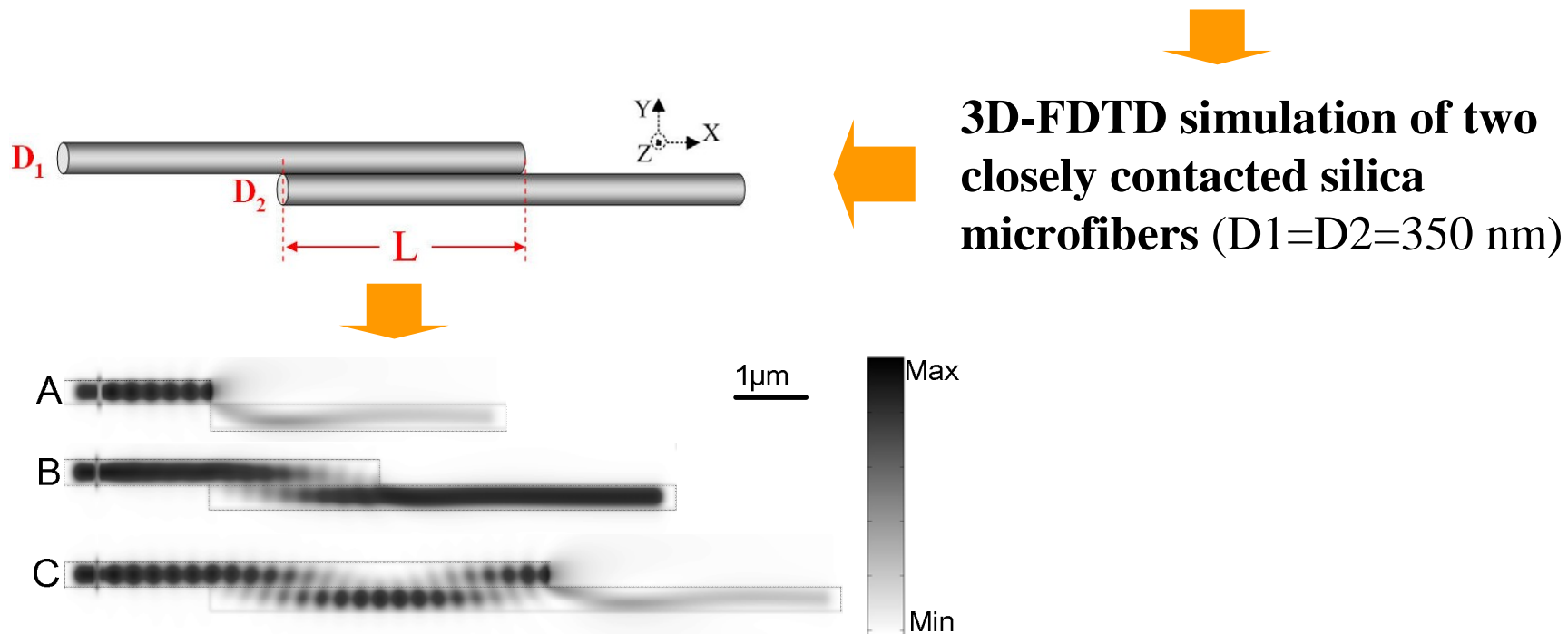

3D-FDTD power maps at 633-nm wavelength with overlapping length of (A) 0, (B) 2.4 μm , and (C) 4.8 μm . The source is z polarized with wavelength of 633 nm.

(1) Near-field Optics

2.1 Near-field coupling between

High fraction of evanescent field →

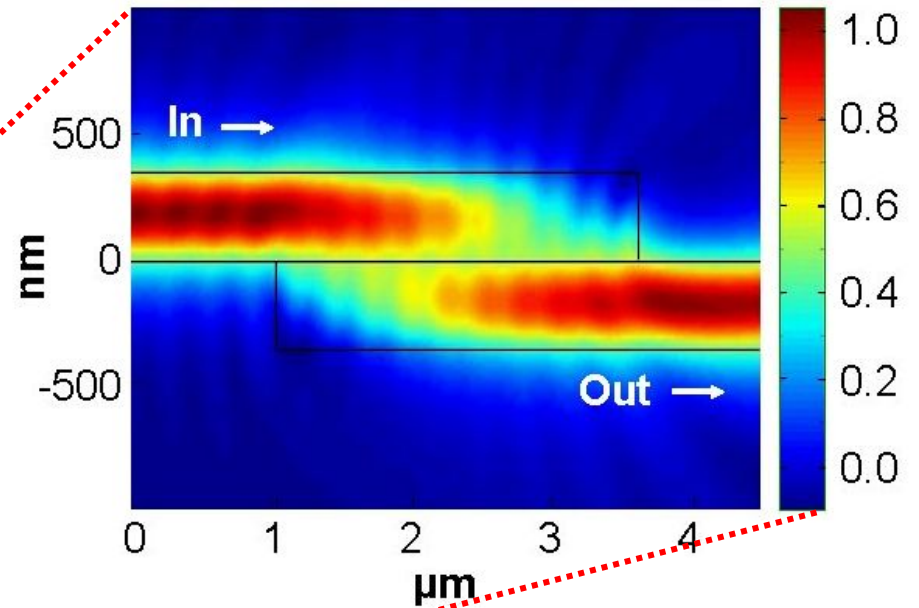
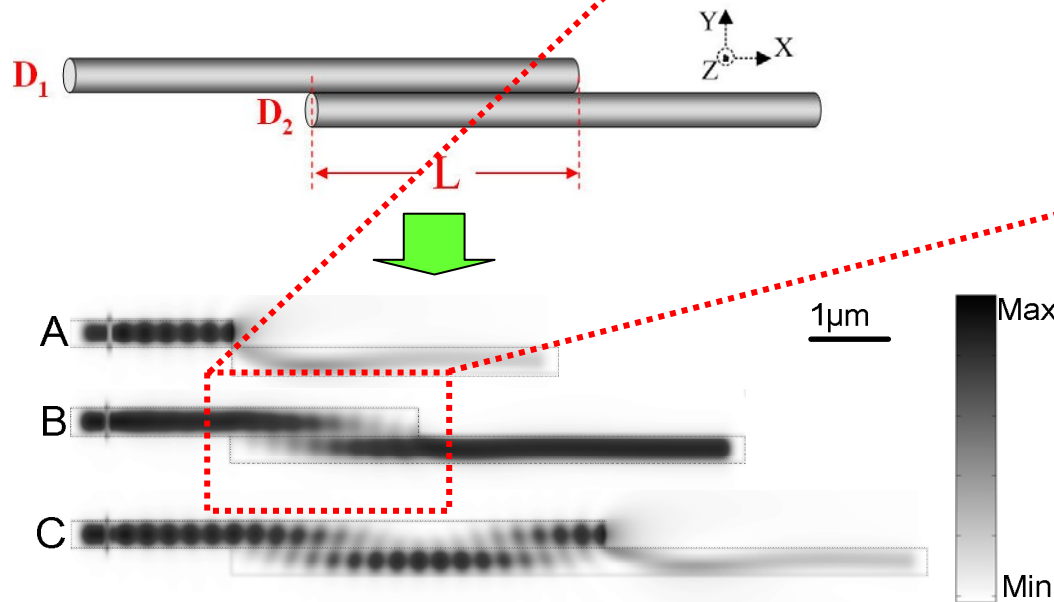

3D-FDTD power maps at 633-nm wavelength with overlapping length of (A) 0, (B) 2.4 μm , and (C) 4.8 μm . The source is z polarized with wavelength of 633 nm.

(1) Near-field Optics

2.1 Near-field coupling between two nanofibers

High fraction of evanescent field \rightarrow Strong near-field interaction

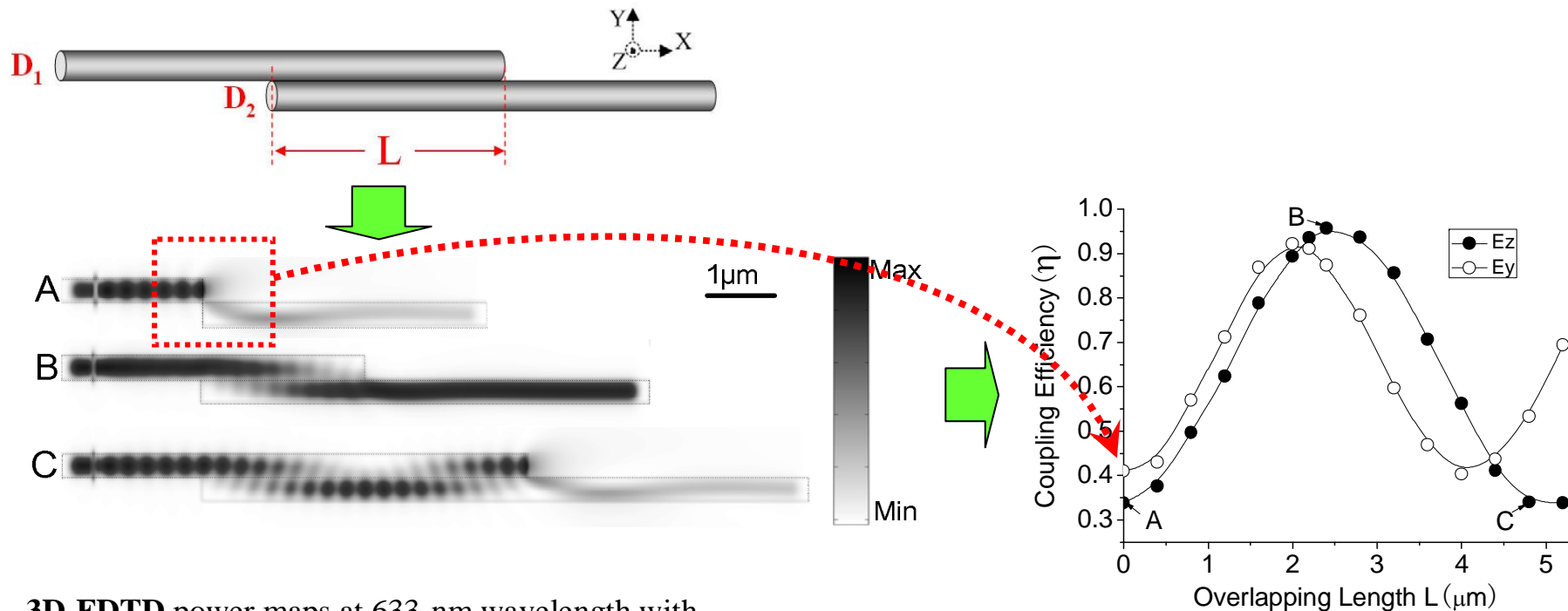

3D-FDTD power maps at 633-nm wavelength with overlapping length of (A) 0, (B) 2.4 μm , and (C) 4.8 μm . The source is z polarized with wavelength of 633 nm.

Overlapping-length-dependent coupling efficiency

(1) Near-field Optics

2.1 Near-field coupling between two nanofibers

Launch light into a nanofiber

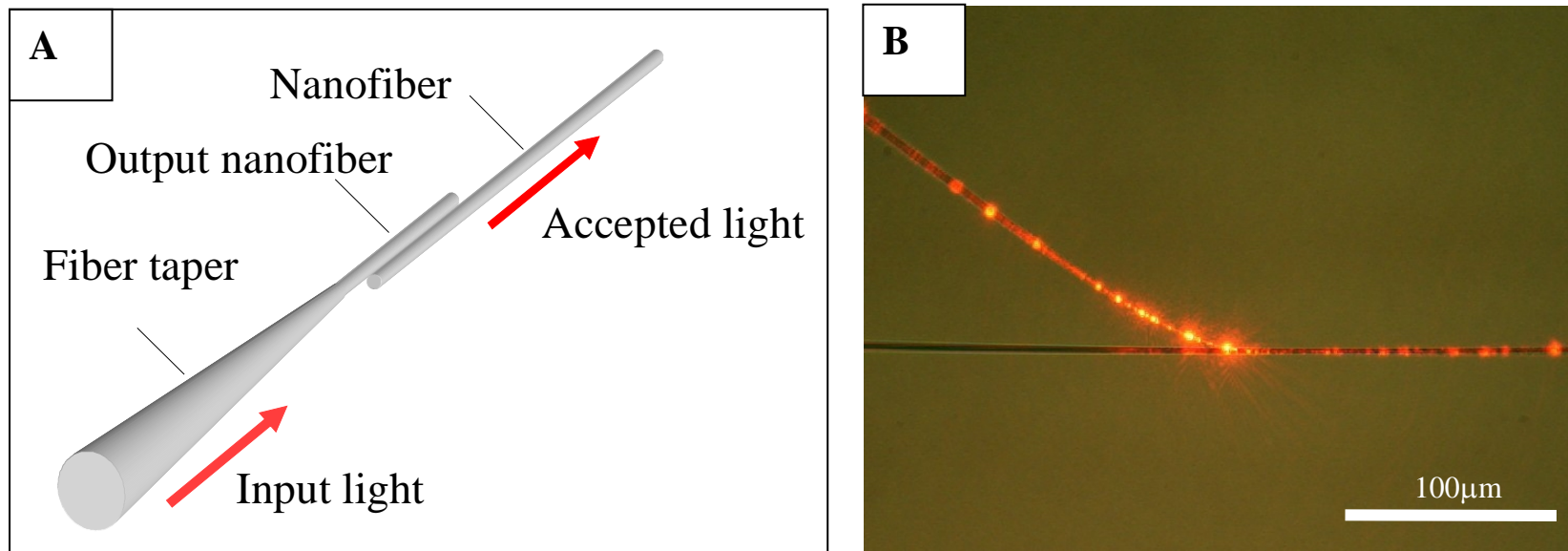

Launching light into microfibers. (A) Schematic diagram for launching light into a silica microfiber using evanescent coupling. (B) Optical microscope image of coupling light from a 390-nm-diameter fiber to a 450-nm-diameter fiber.

(1) Near-field Optics

2.1 Near-field coupling between two nanofibers

- **Micro-coupler**

Micro-coupler assembled with two tellurite fibers on a silica substrate

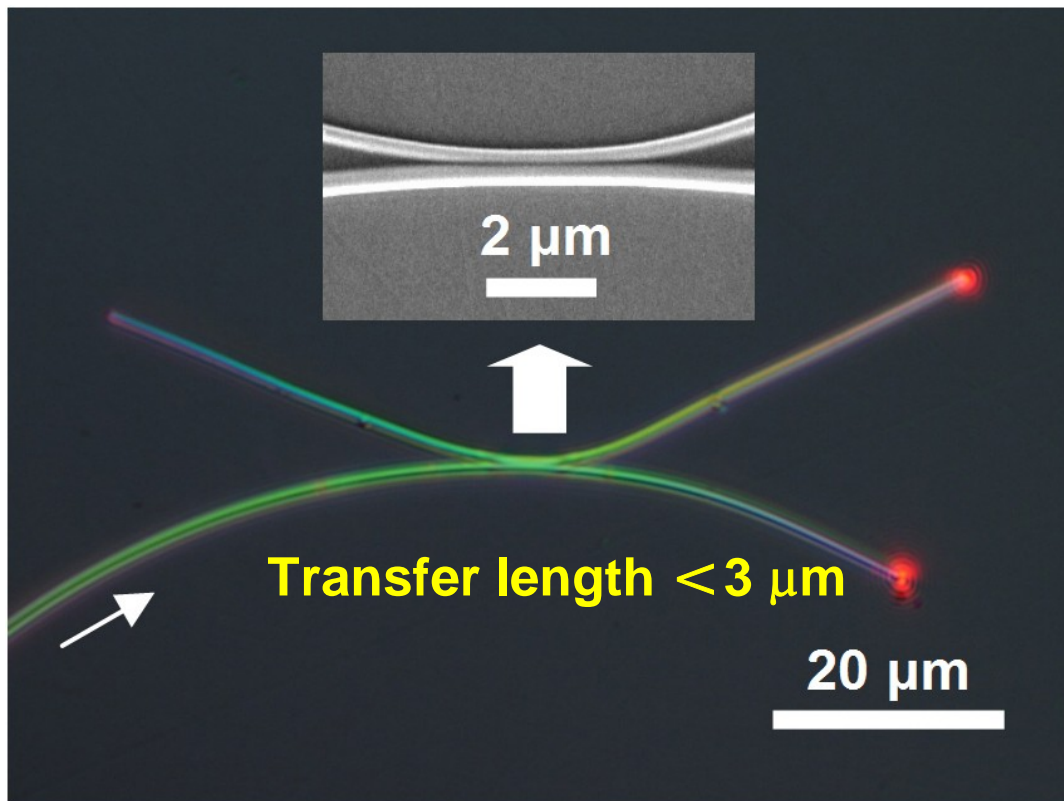

Fiber diameter: 350/450 nm

Working wavelength: 633 nm

Overlapping < 3 μm

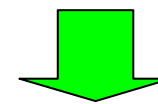

3-dB splitter

(1) Near-field Optics

2.1 Near-field coupling between two nanofibers

- Tiny Mach-Zehnder interferometer

When two micro-couplers are assembled in cascade → MZI

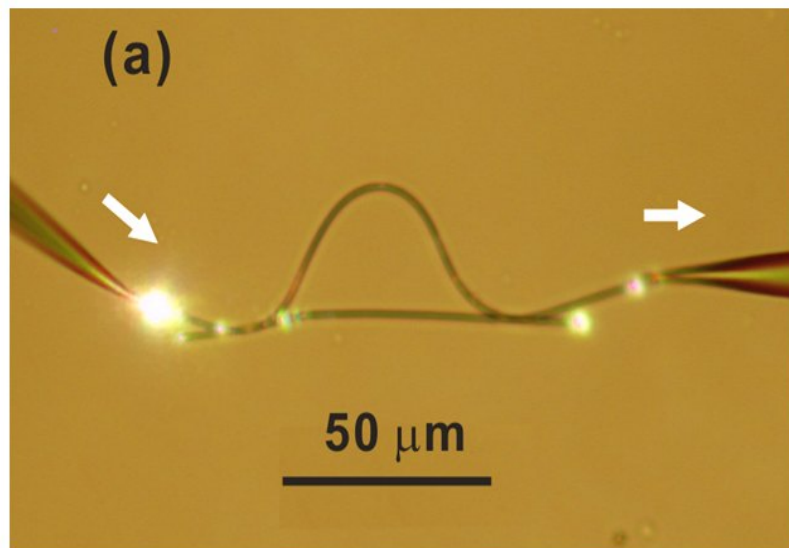

MZI assembled with two 480-nm-diameter tellurite fibers on a MgF₂ substrate

(1) Near-field Optics

2.1 Near-field coupling between two nanofibers

- Tiny Mach-Zehnder interferometer

When two micro-couplers are assembled in cascade → MZI

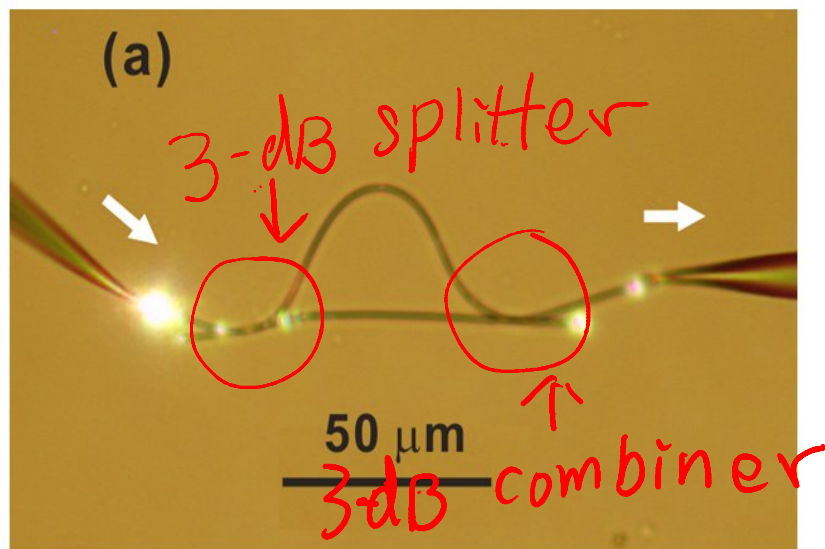

MZI assembled with two 480-nm-diameter tellurite fibers on a MgF₂ substrate

(1) Near-field Optics

2.1 Near-field coupling between two nanofibers

- Tiny Mach-Zehnder interferometer

When two micro-couplers are assembled in cascade → MZI

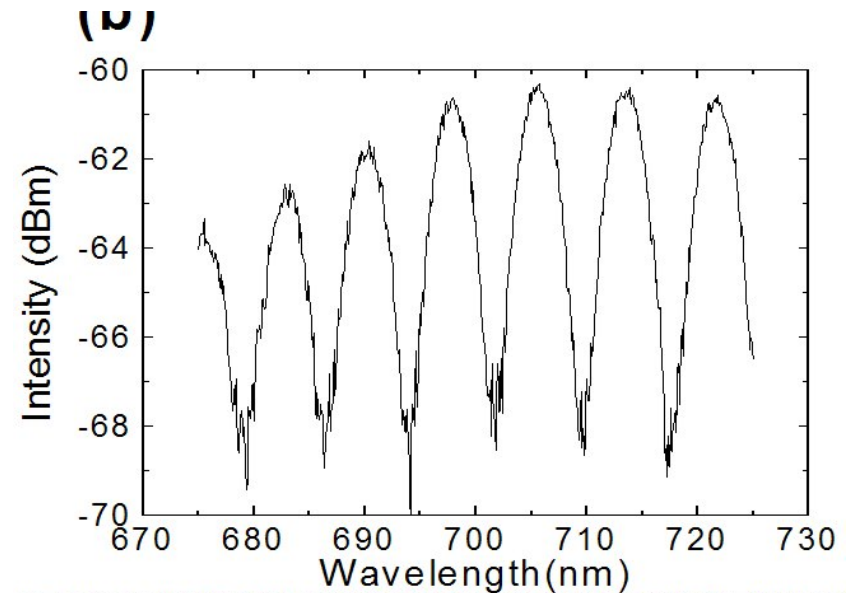
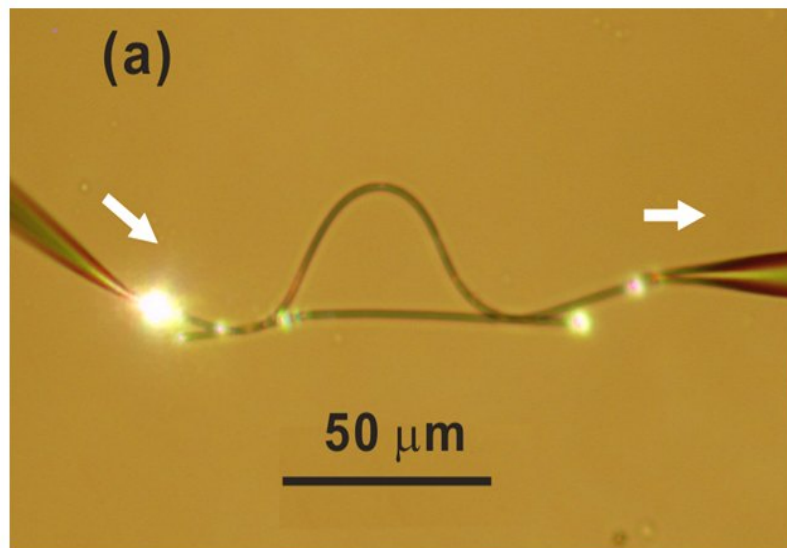

MZI assembled with two 480-nm-diameter tellurite fibers on a MgF₂ substrate

Transmission spectrum of the MZI



Small footprint and high flexibility

(1) Near-field Optics

2.1 Near-field coupling between two nanofibers

- Micro resonator

Tie a microfiber into a loop or knot → ring resonator

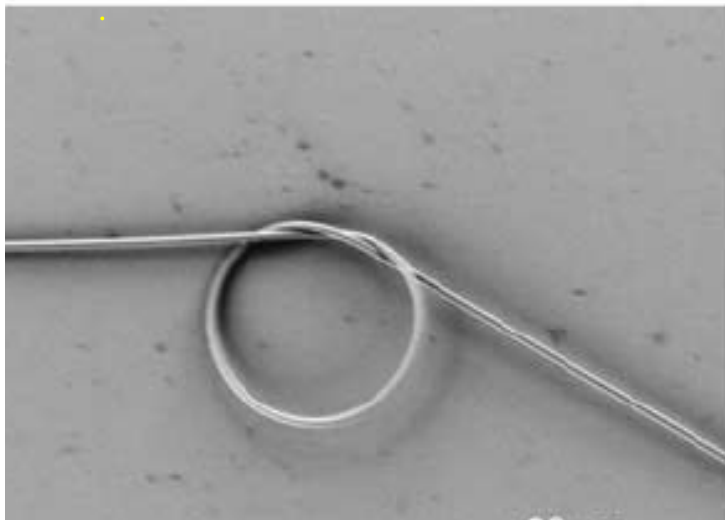

(1) Near-field Optics

2.1 Near-field coupling between two nanofibers

- Micro resonator

Tie a microfiber into a loop or knot → ring resonator

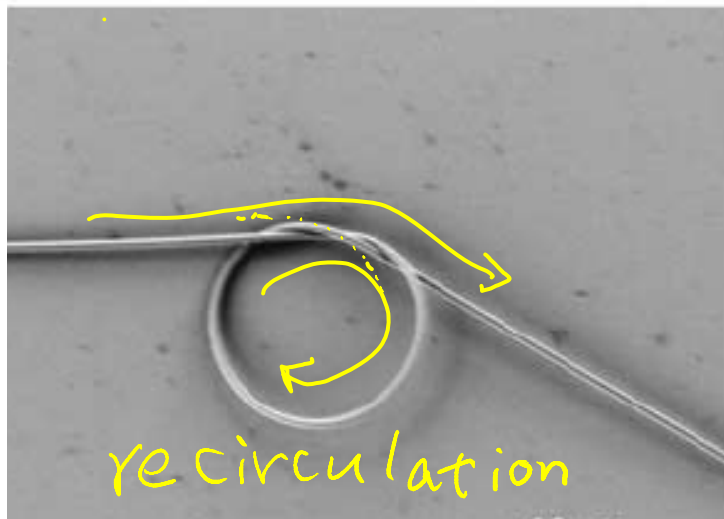

(1) Near-field Optics

2.1 Near-field coupling between two nanofibers

- Micro resonator

Tie a microfiber into a loop or knot → ring resonator

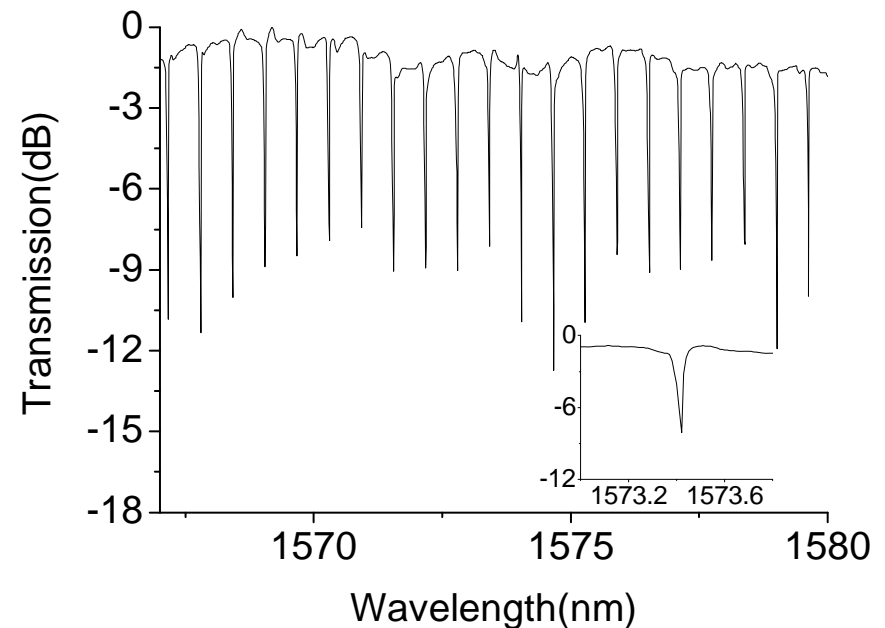
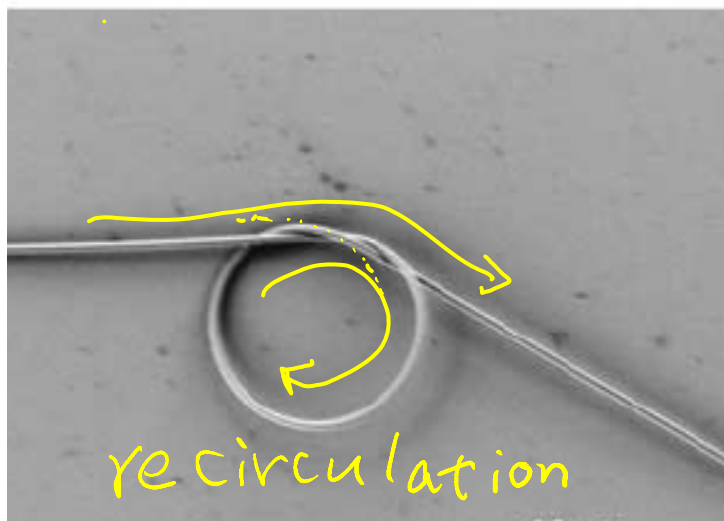

(1) Near-field Optics

- Micro Lasers : **Rare-earth-doped microfiber laser**

Microfiber knot resonator + doped with active ions → Microfiber knot laser

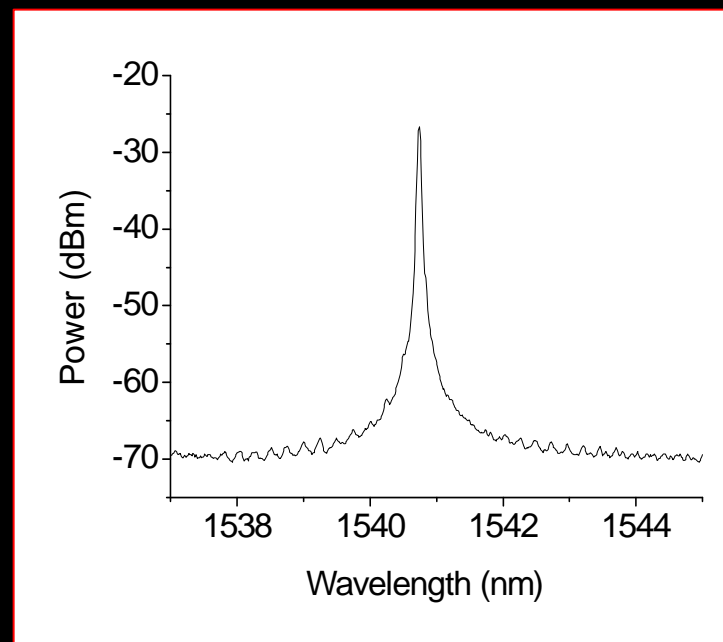
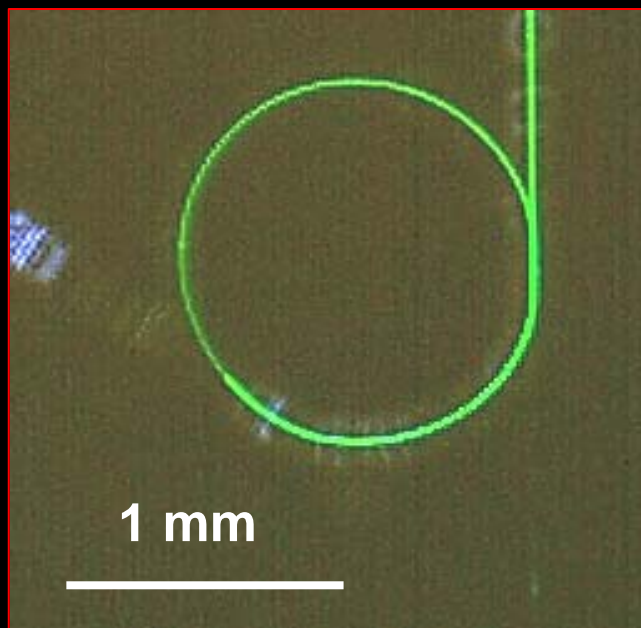

Fiber material: (Er, Yb) codoped phosphate glass

Fiber diameter $\sim 3.8 \mu\text{m}$

Knot diameter $\sim 2 \text{ mm}$

Pump wavelength $\sim 975 \text{ nm}$

Laser output $\sim 1.54 \mu\text{m}$, power $> 8 \mu\text{W}$

X. Jiang et al., *Appl. Phys. Lett.* **89**, 143513 (2006)

(1) Near-field Optics

- Micro Lasers : **Microfiber dye laser**

(1) silica microfiber – laser dye molecules

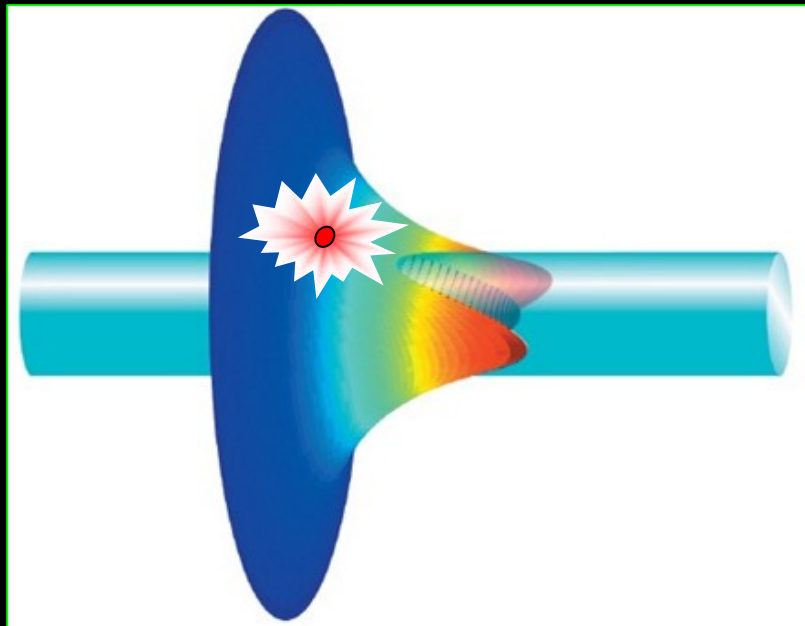

Near-field excitation of dye molecules

(1) Near-field Optics

- Micro Lasers : **Microfiber dye laser**

(1) silica microfiber – laser dye molecules

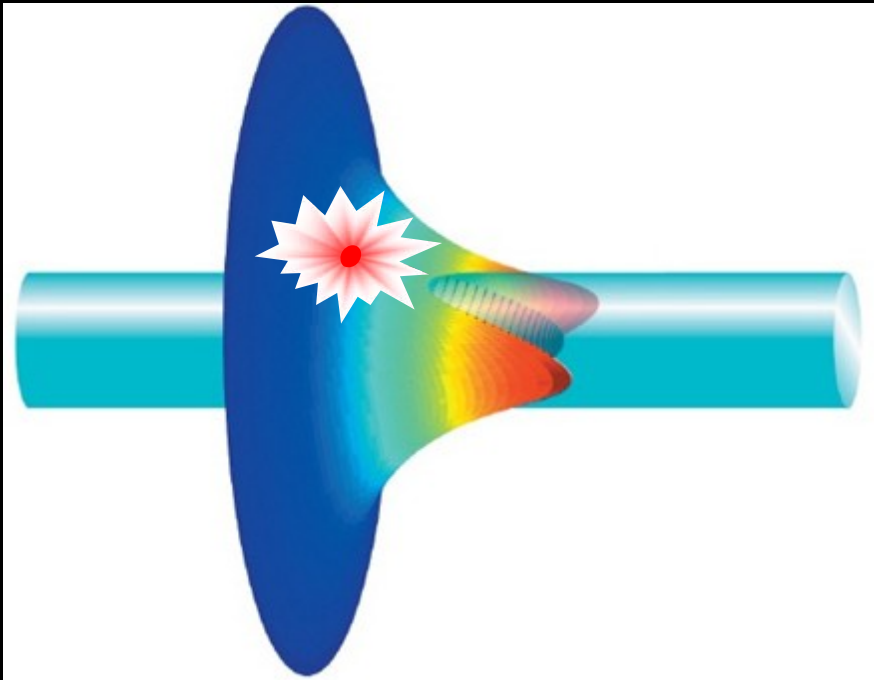

Near-field excitation of dye molecules

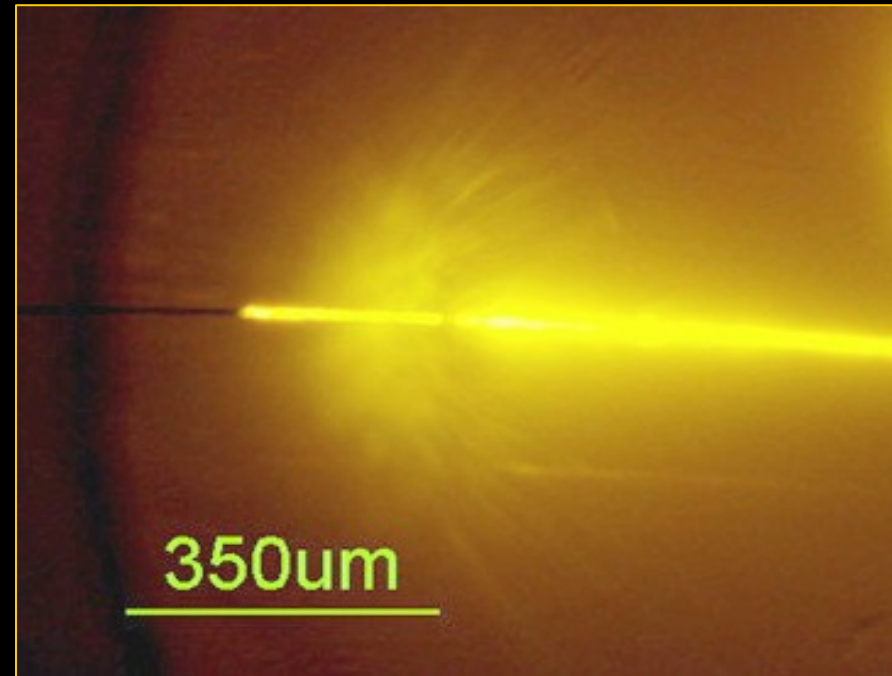

R6G dye solution excited by a 532-nm-wavelength light guided along a 3- μ m-diameter silica microfiber

(1) Near-field Optics

- Micro Lasers : **Microfiber dye**

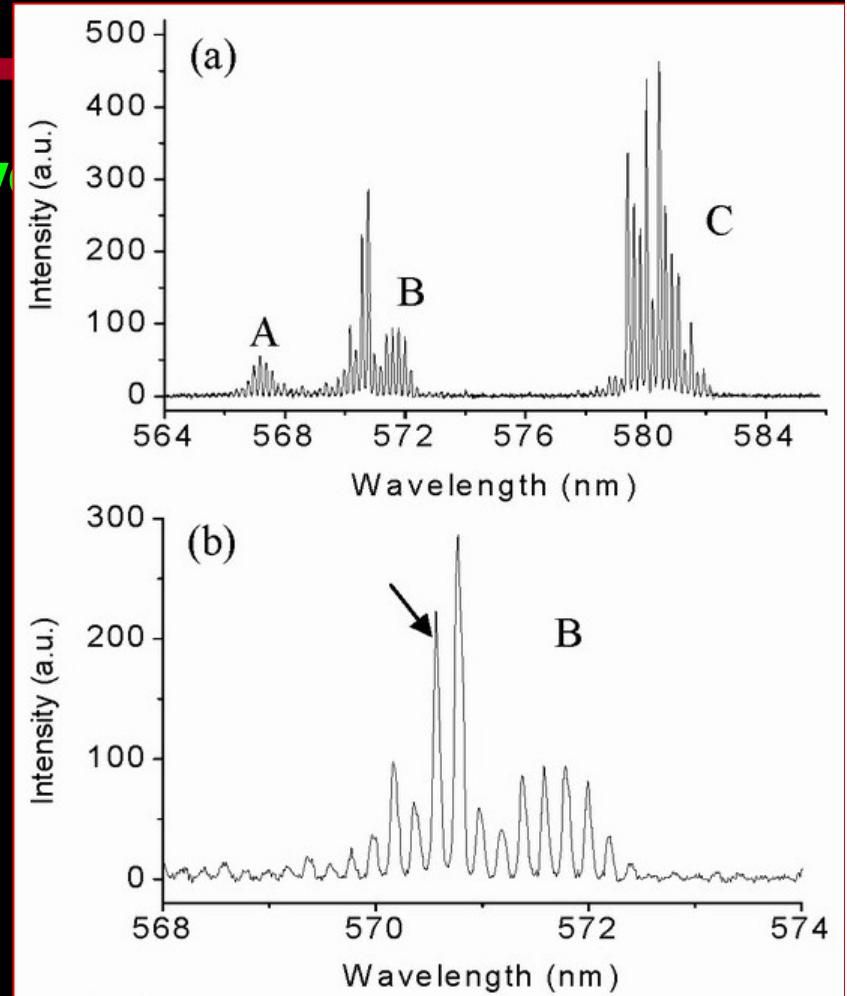
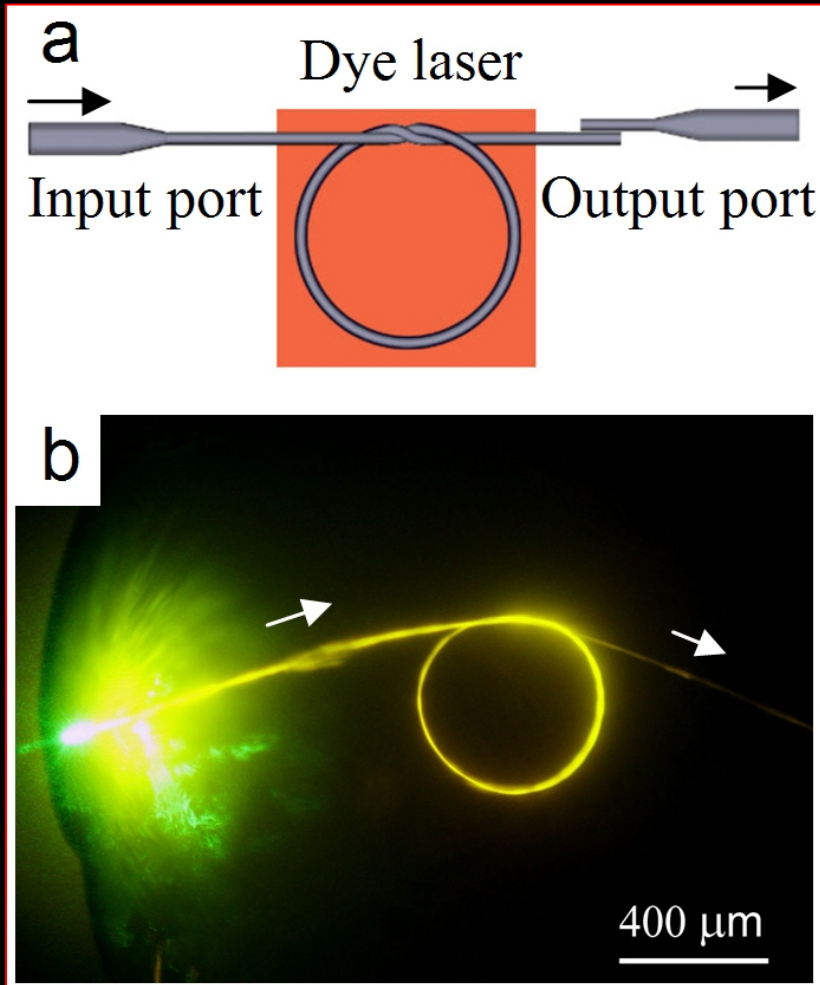

Laser emission from a 350-μm-diameter microfiber knot dye laser (fiber diameter ~ 3.9 μm) . Threshold 10 μJ/pulse, Q 10,000

Silica microfiber knot dye laser:
(R6G) solution: 5 mM/l, Pump wavelength: 532 nm

X. Jiang et al., *Appl. Phys. Lett.* **90**, 233501 (2007)

(1) Near-field Optics

- Micro Lasers : **Microfiber–ZnO-nanowires laser**

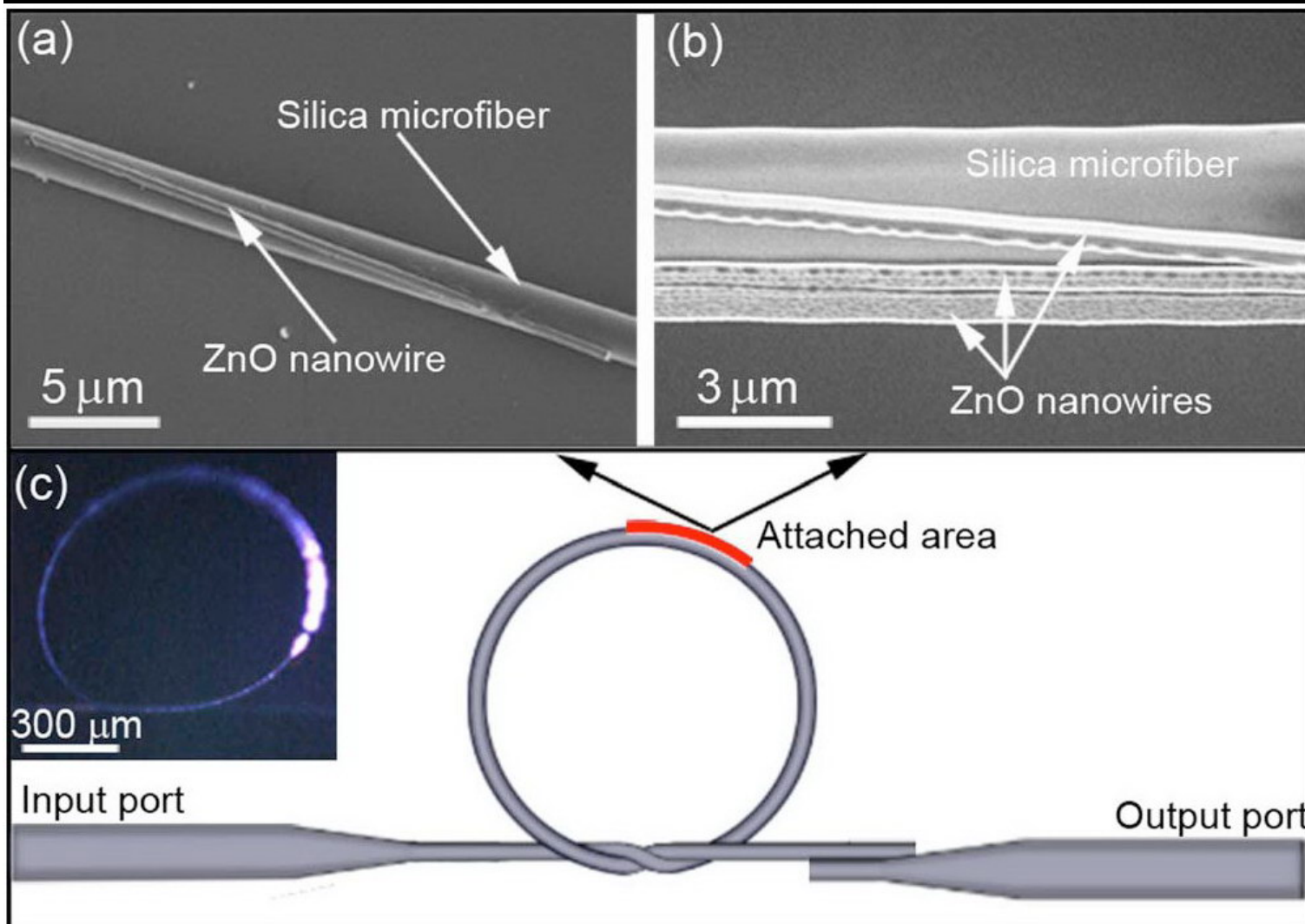

(1) Near-field Optics

- Micro Lasers : **Microfiber–ZnO-nanowires laser**

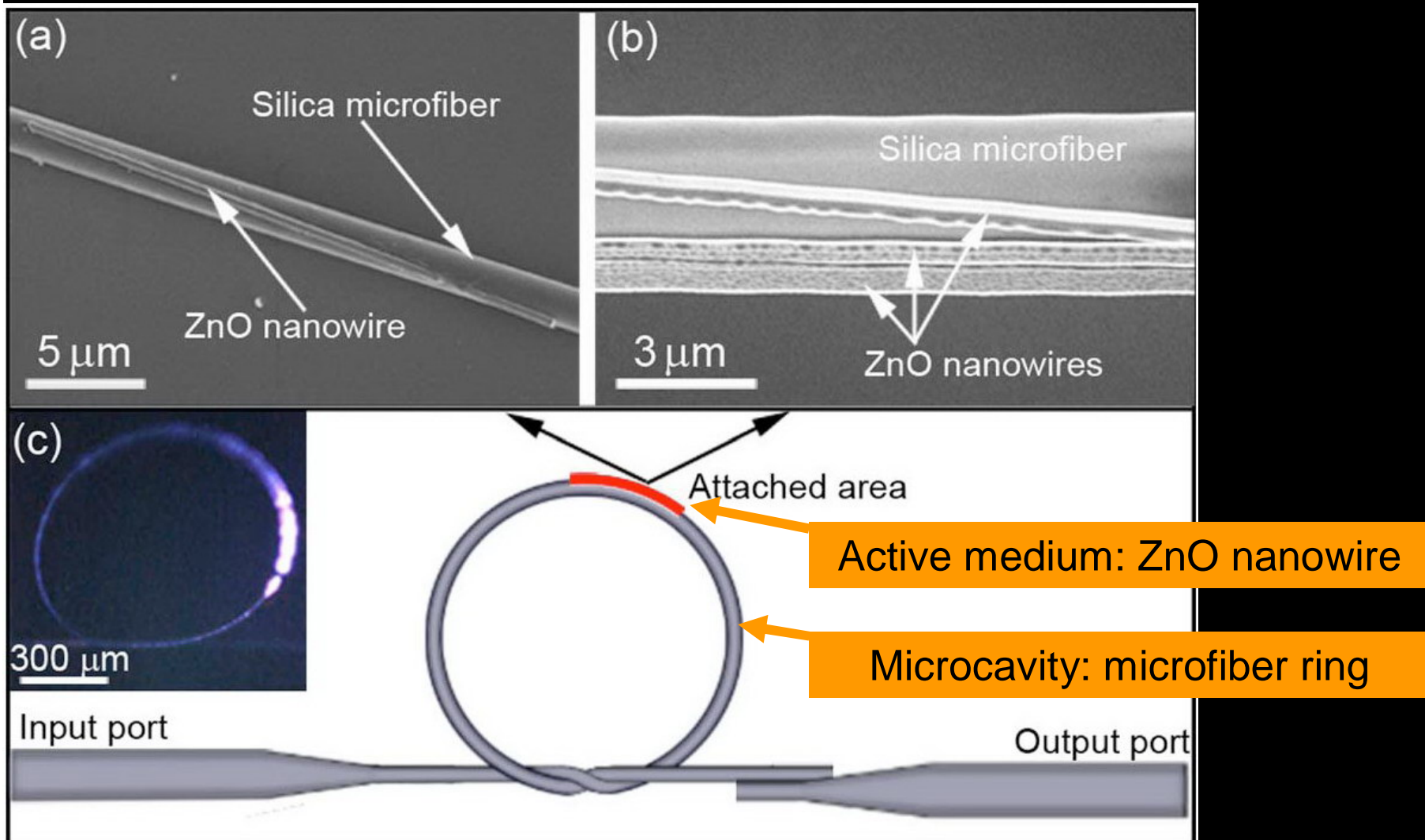

(1) Near-field Optics

- Micro Lasers : Mic

Pump pulses:
355 nm, 6 ns, 10 Hz

Hybrid nanowire lasers

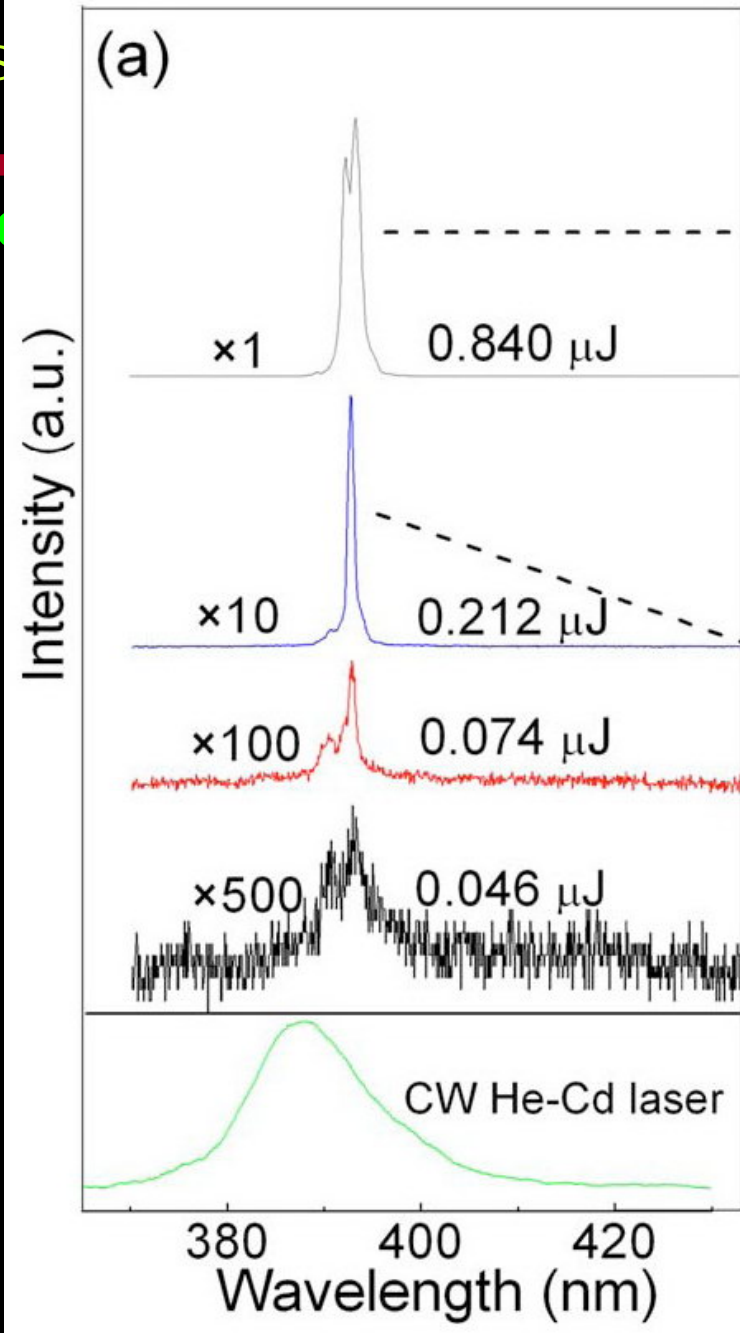
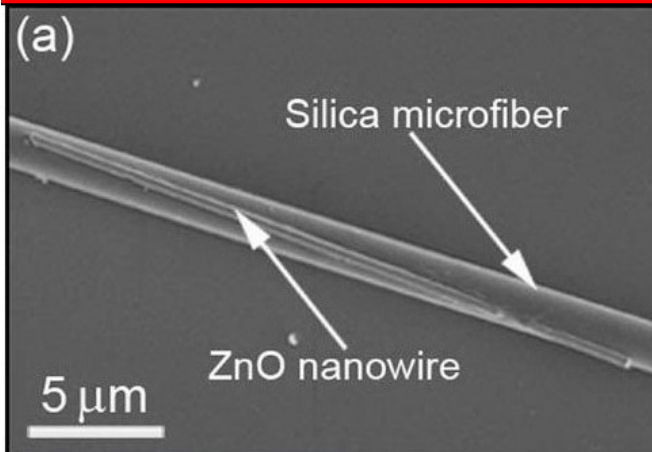

laser

(1) Near-field Optics

- Micro Lasers : Mic

Pump pulses:
355 nm, 6 ns, 10 Hz

Hybrid nanowire lasers

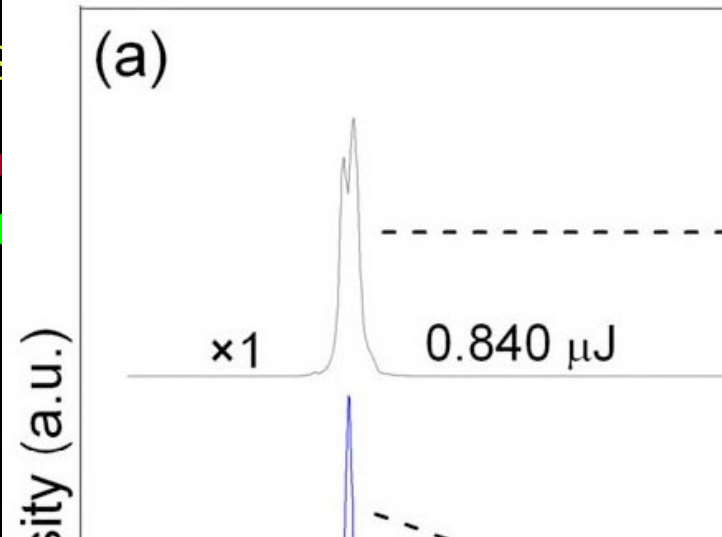
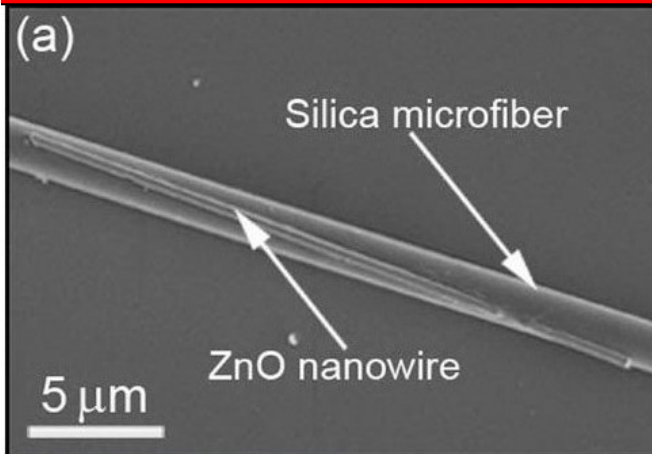

laser

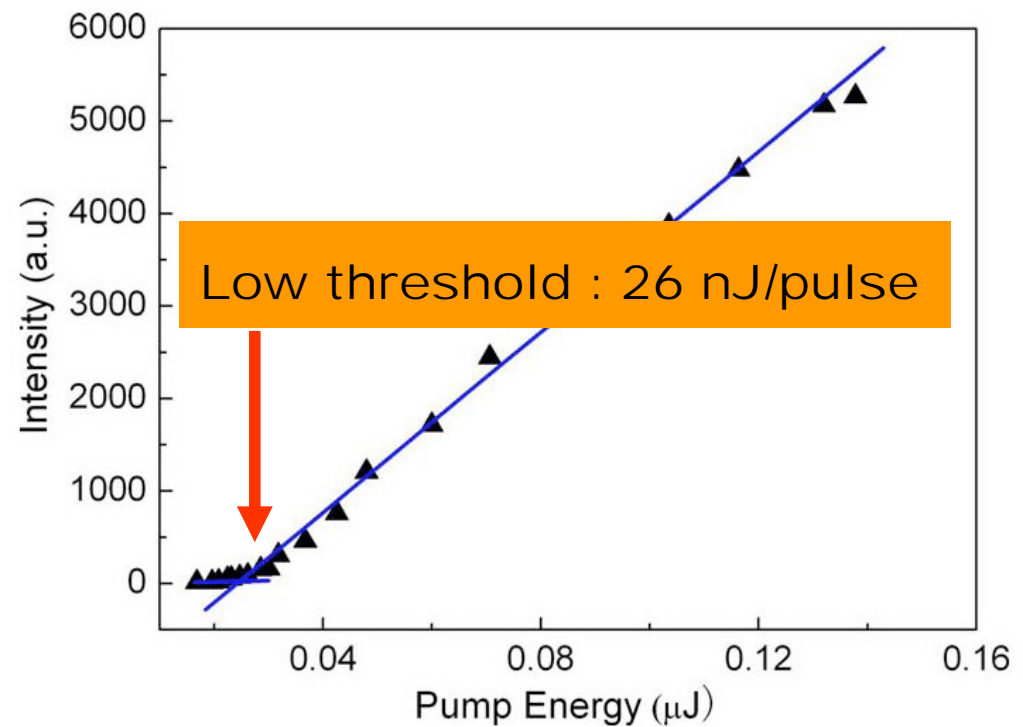

(1) Near-field Optics

2.2 Near-field coupling for optical sensing

- Substrate induced leakage

3-D FDTD simulation

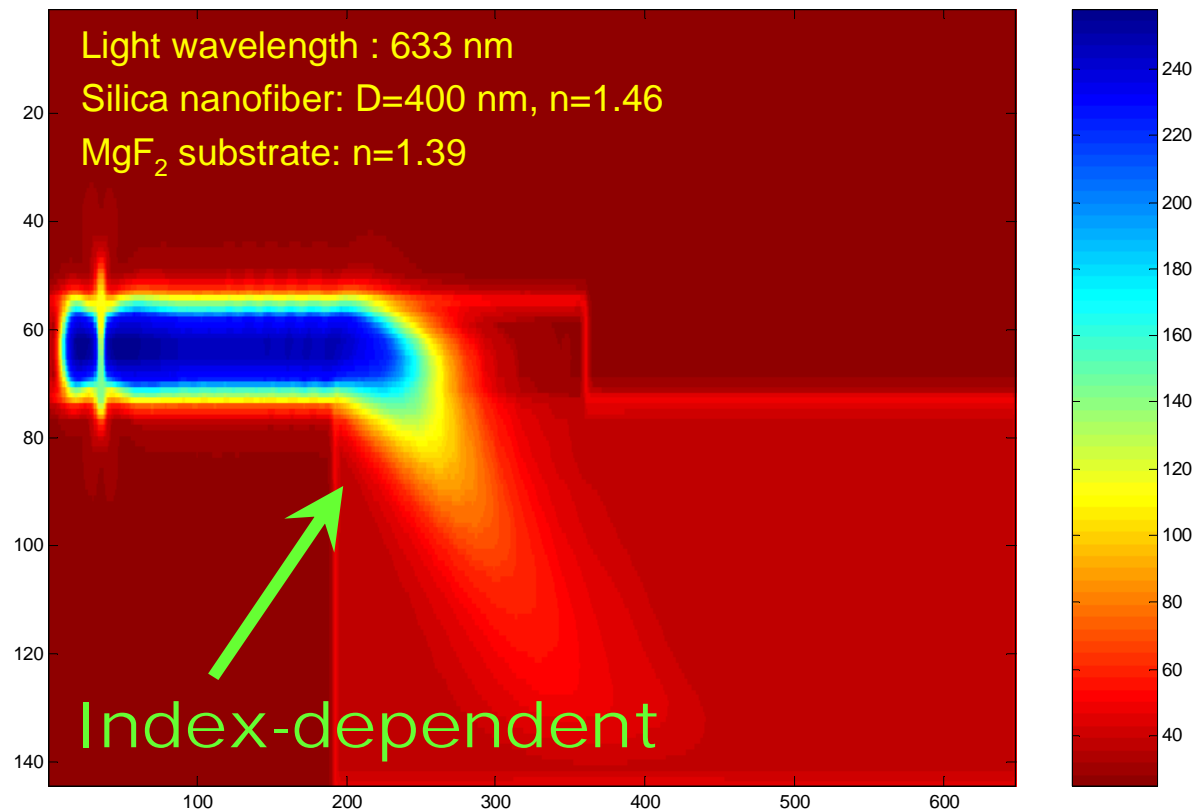

(1) Near-field Optics

- Micro filters
silica microfiber – MgF_2 substrate

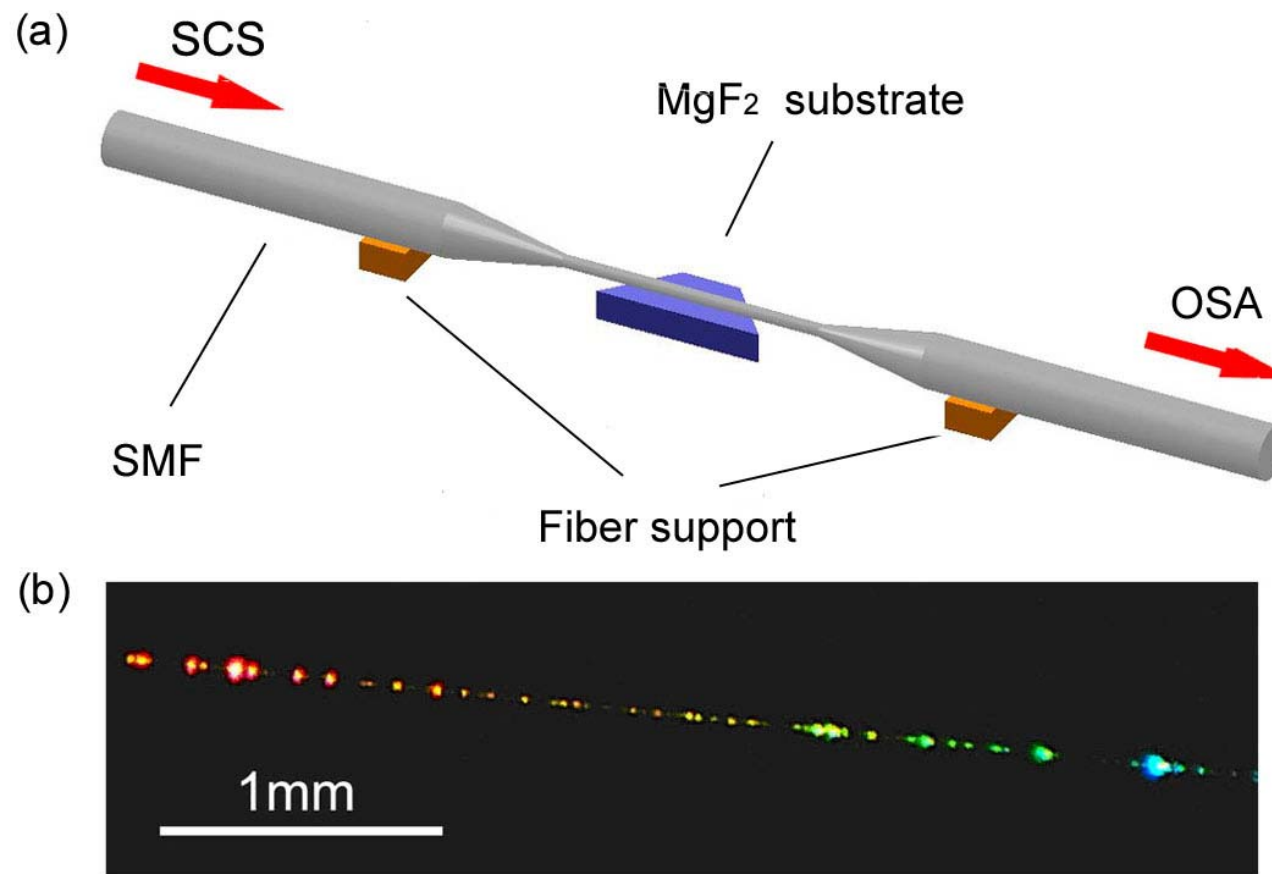

wavelength-dependent leakage

(1) Near-field Optics

- Micro filters

Short-pass filter

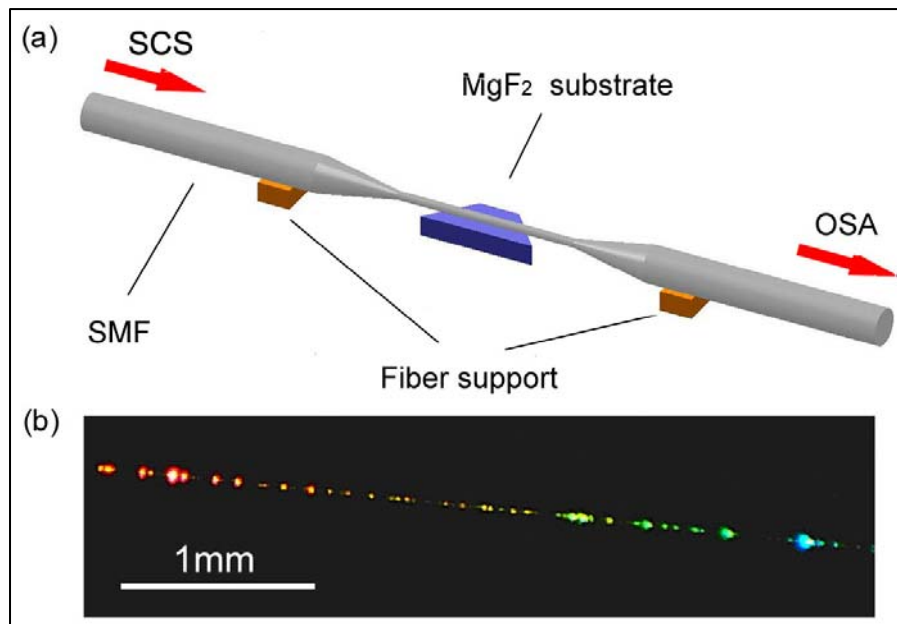
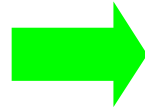

(a) Normalized transmission spectra with microfiber diameters of ①0.75, ②0.88, ③1.17, ④1.29, ⑤1.42, ⑥1.72, ⑦1.82, ⑧1.96 μm . The interaction length is 1.1 mm. (b) Cutoff wavelength versus microfiber diameter.

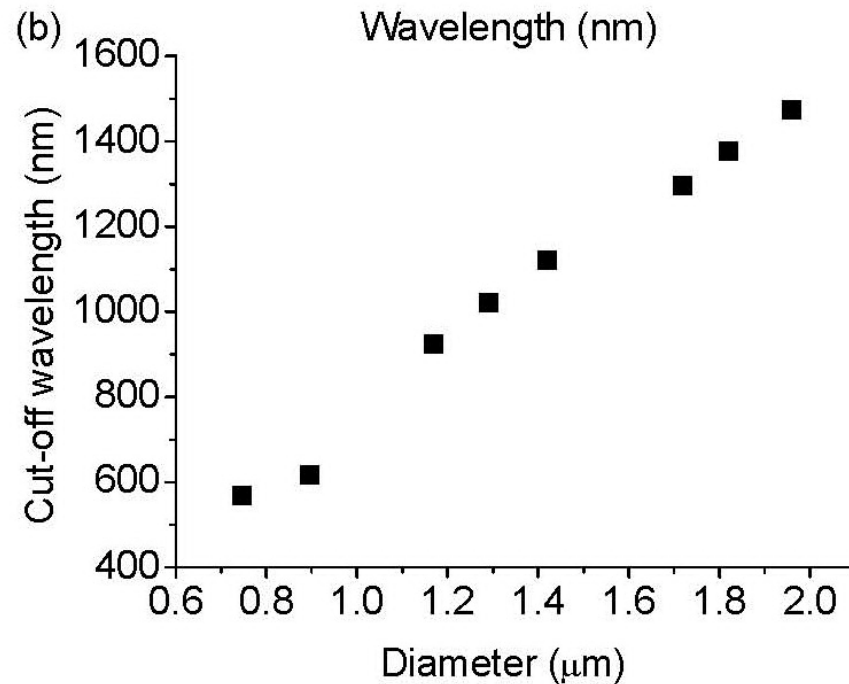
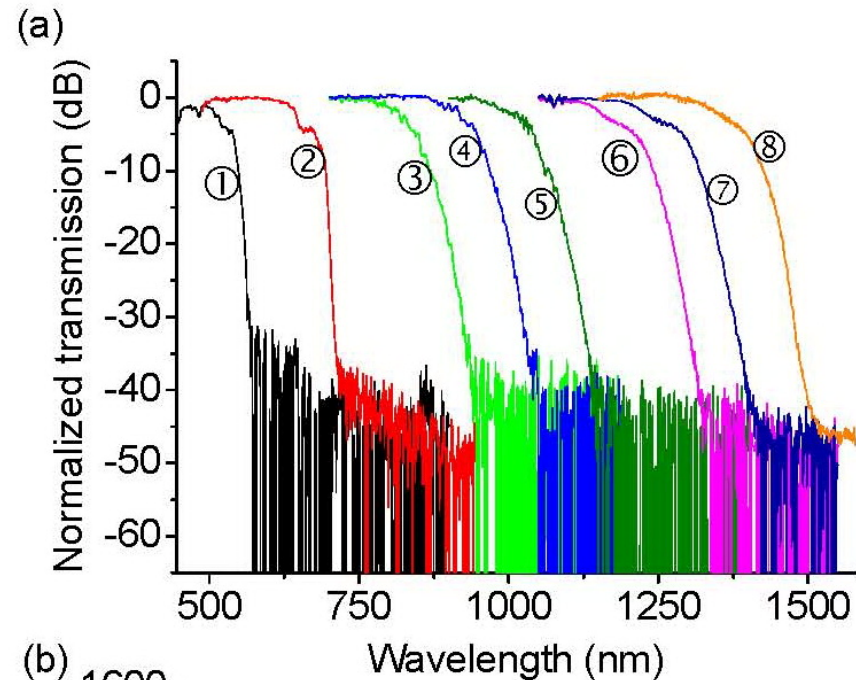

(1) Near-field Optics

2.2 Near-field coupling for

- Nanofiber sensors

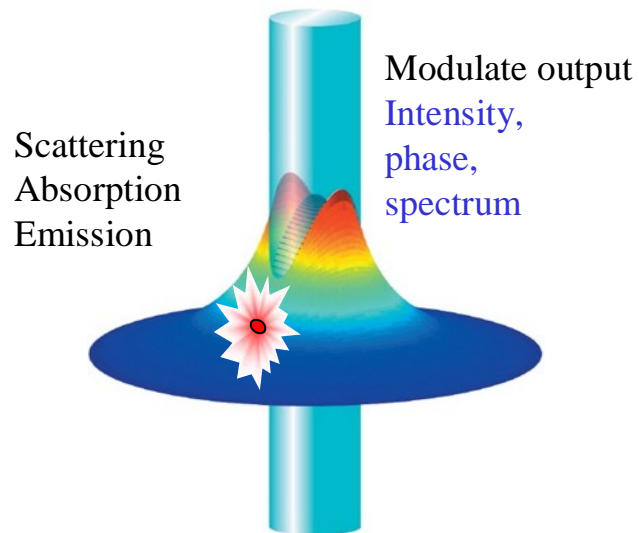

Small footprint
High sensitivity
Fast response

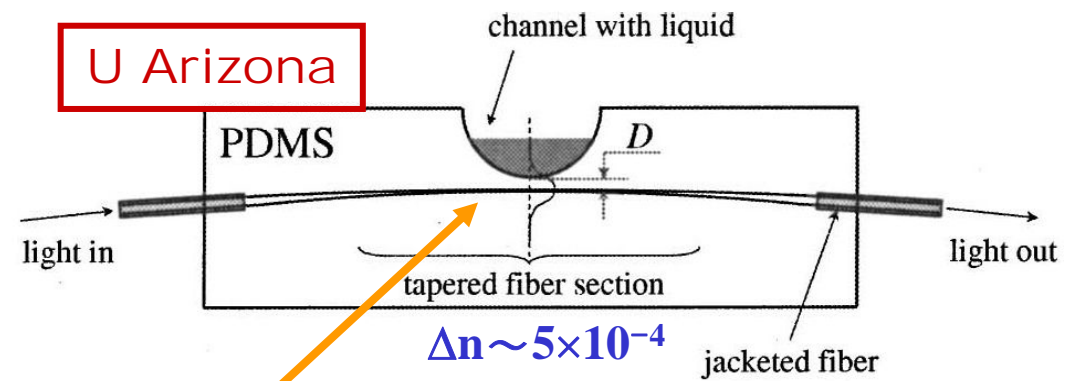
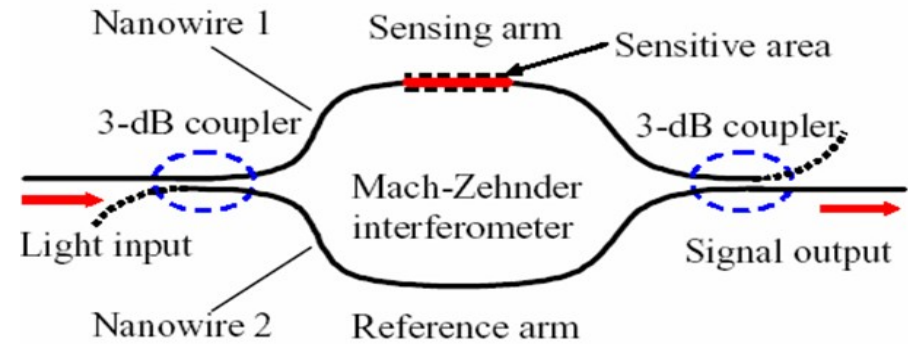
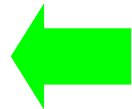

U Arizona

microfiber

Mexico

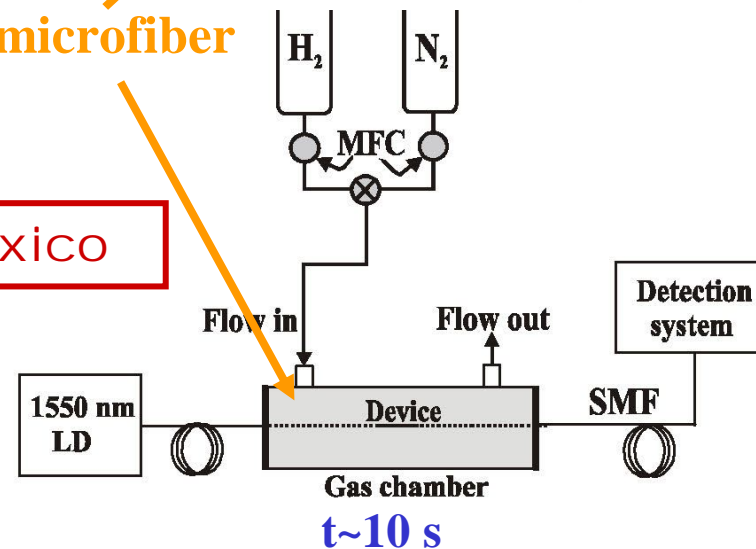

[9] J. Lou et al., *Opt. Express* **13**, 2135 (2005)
 [10] P. Polynkin et al., *Opt. Lett.* **30**, 1273 (2005)
 [11] J. Villatoro et al., *Opt. Express* **13**, 5087 (2005)

Outline

3. Potentials and Applications

(1) Near-Field Optics

(2) Plasmonics

(3) Nonlinear Optics

(4) Quantum Optics\Atom Optics

(5) Photon Momentum

(2) Plasmonics

- Plasmonics

	Dielectric	v.s.	Plasmonic
Confinement	$< \lambda/5$		$\sim \lambda/10$
Loss	Low		Very high



Two questions: (1) loss – confinement
(2) high efficient launching

(2) Plasmonics

Hybrid nanofiber-nanowire structure

Direct coupling of silica nanofibers and silver nanowires

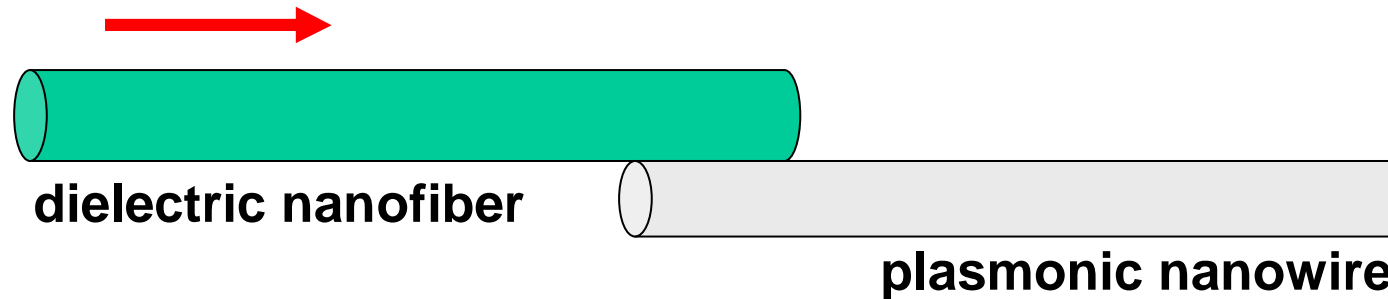

(2) Plasmonics

Hybrid nanofiber-nanowire structure

Can we couple a dielectric nanowire and a plasmonic nanowire?

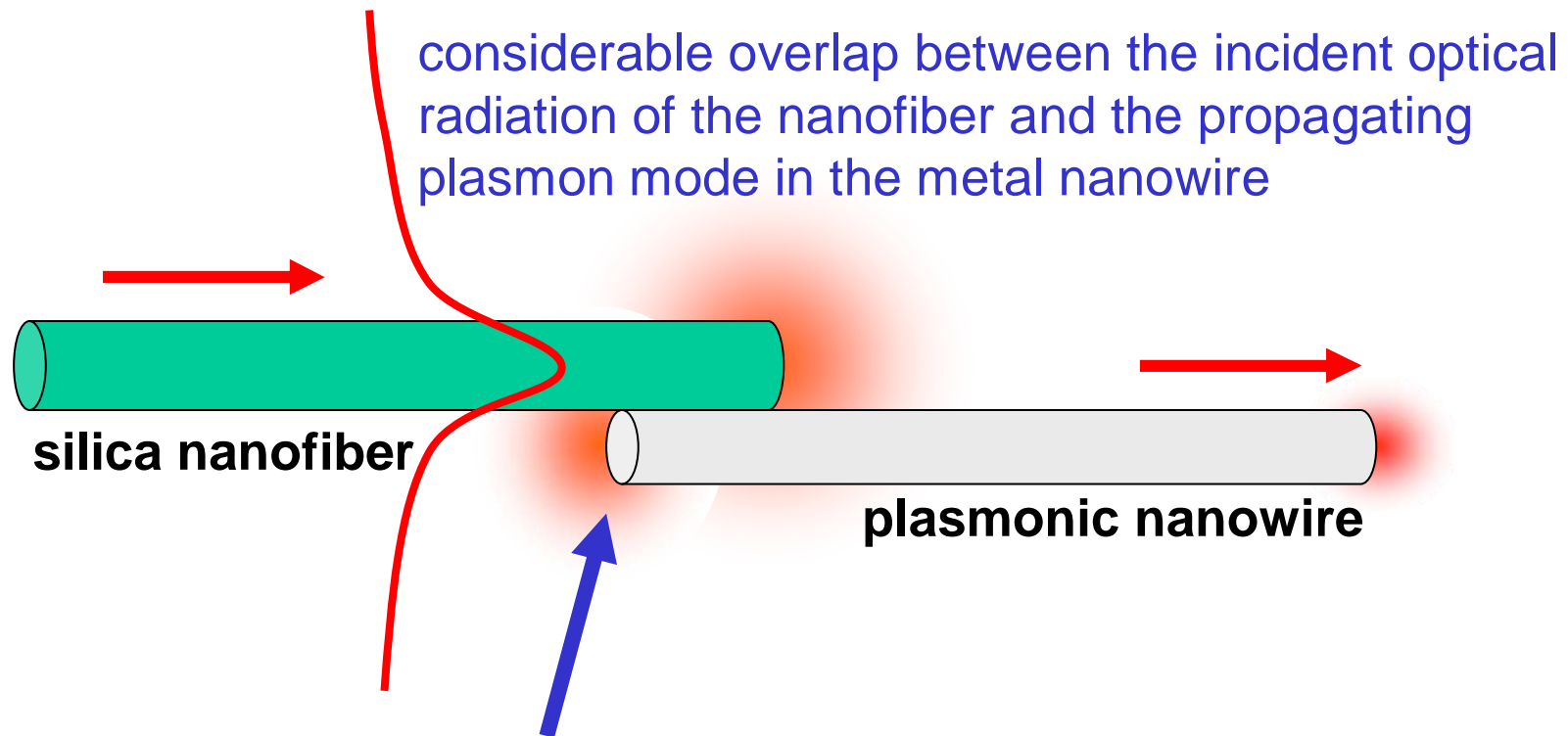

the small end of the silver nanowire scatters evanescent waves for compensating momentum mismatch between the dielectric and the plasmonic waveguides

Coupling a 633-nm-wavelength light from a 500-nm-diameter silica nanofiber to a 200-nm-diameter silver nanowire

Silica nanofiber

Silver nanowire

20 μm

(2) Plasmonics

Hybrid nanofiber-nanowire structure

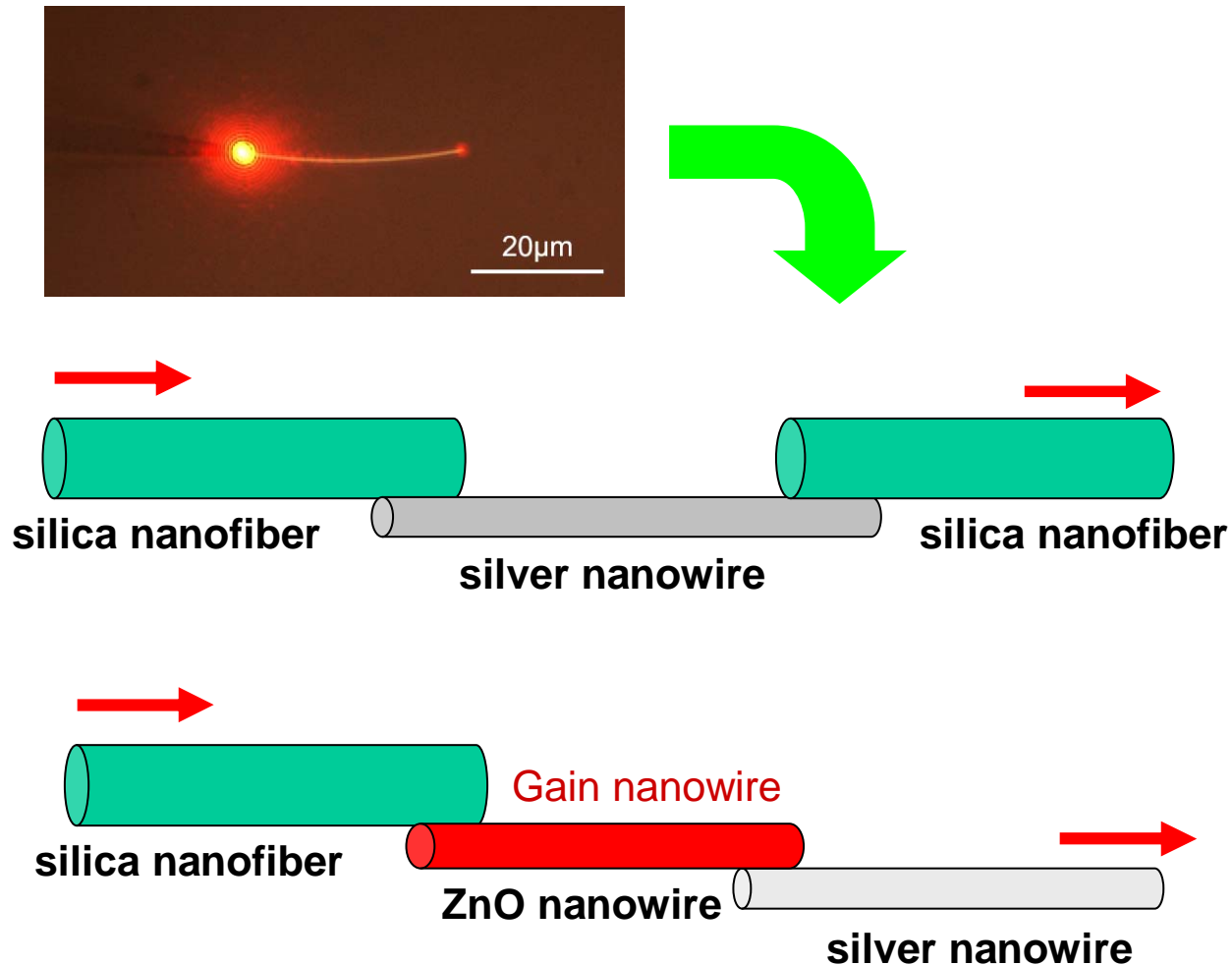

Advantages

- Convenient and efficient input/output
- Loss reduction/compensation by dielectric/gain nanowire
- Compatible with optical fiber system

(2) Plasmonics

Hybrid nanofiber-nanowire structure

Polarization-dependent coupling efficiency

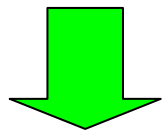
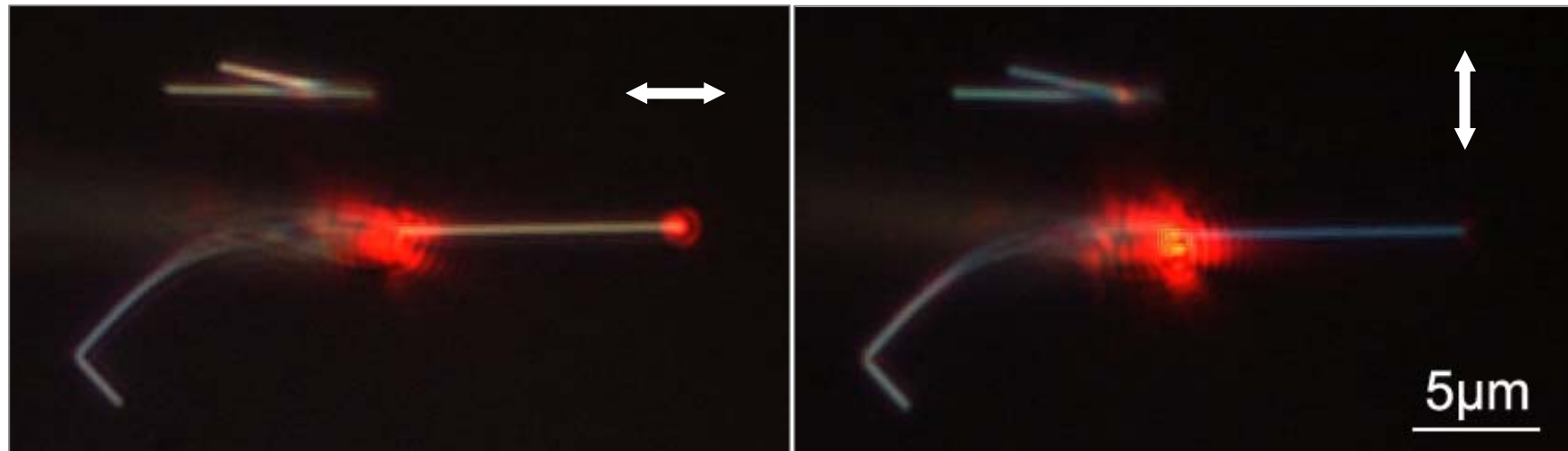

Polarization splitters

Branch couplers

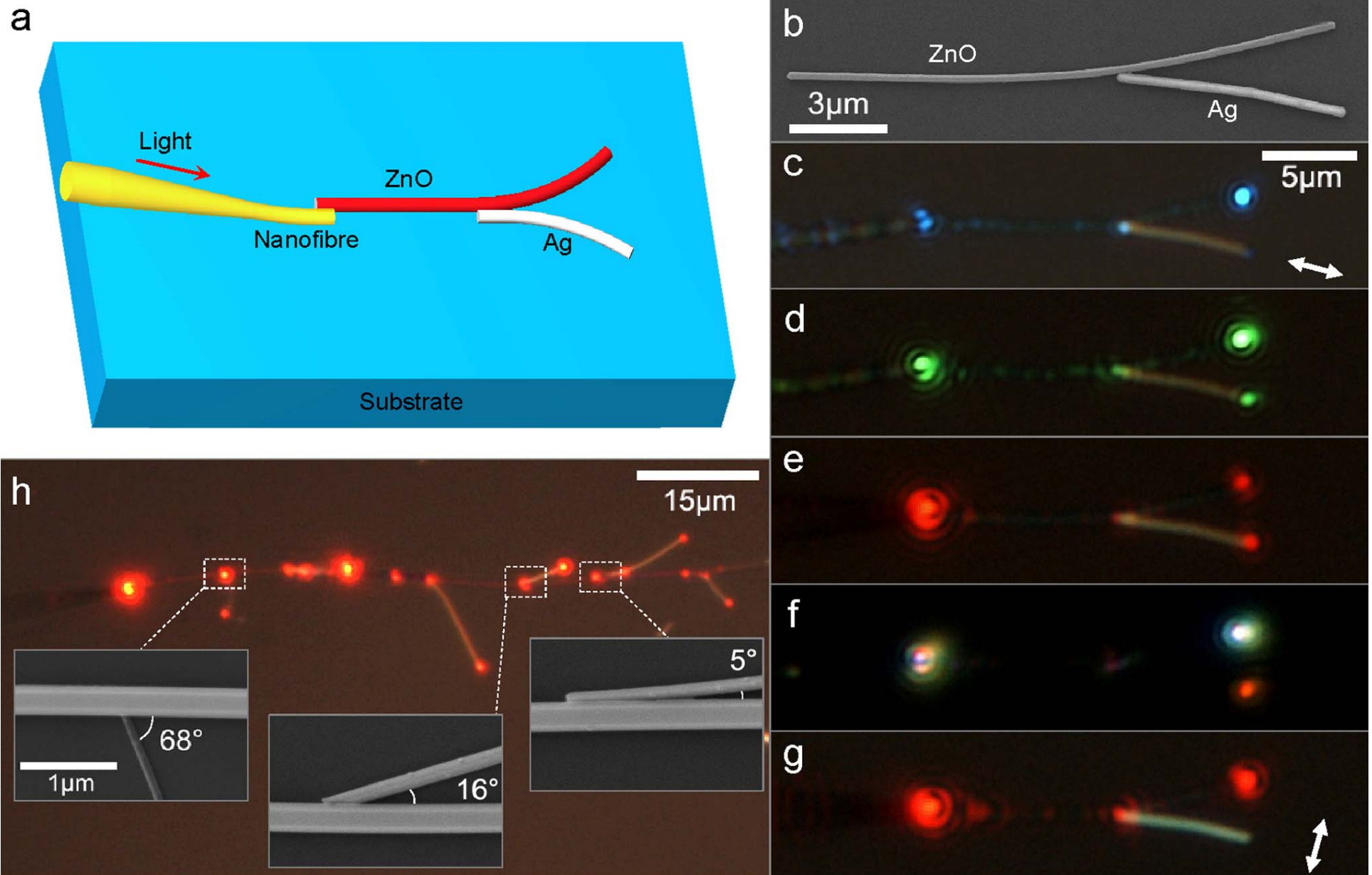

Branch couplers

a

Coupling efficiency
up to 80%
with a coupling length
around 200 nm

500-nm-diameter silica nanofiber
270-nm-diameter ZnO nanowire
240-nm-diameter Ag nanowire
@ 650-nm wavelength

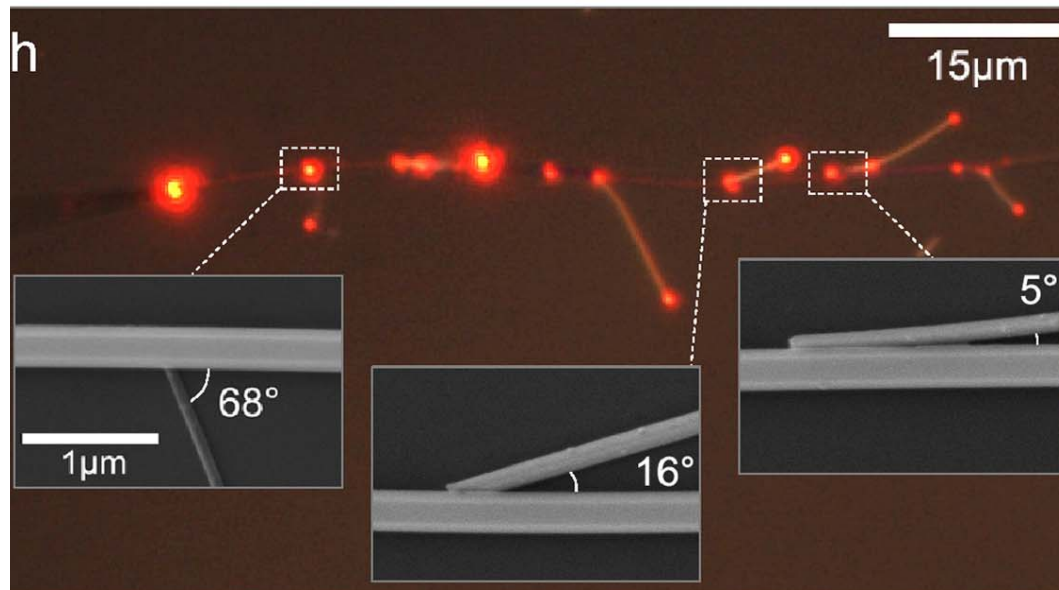
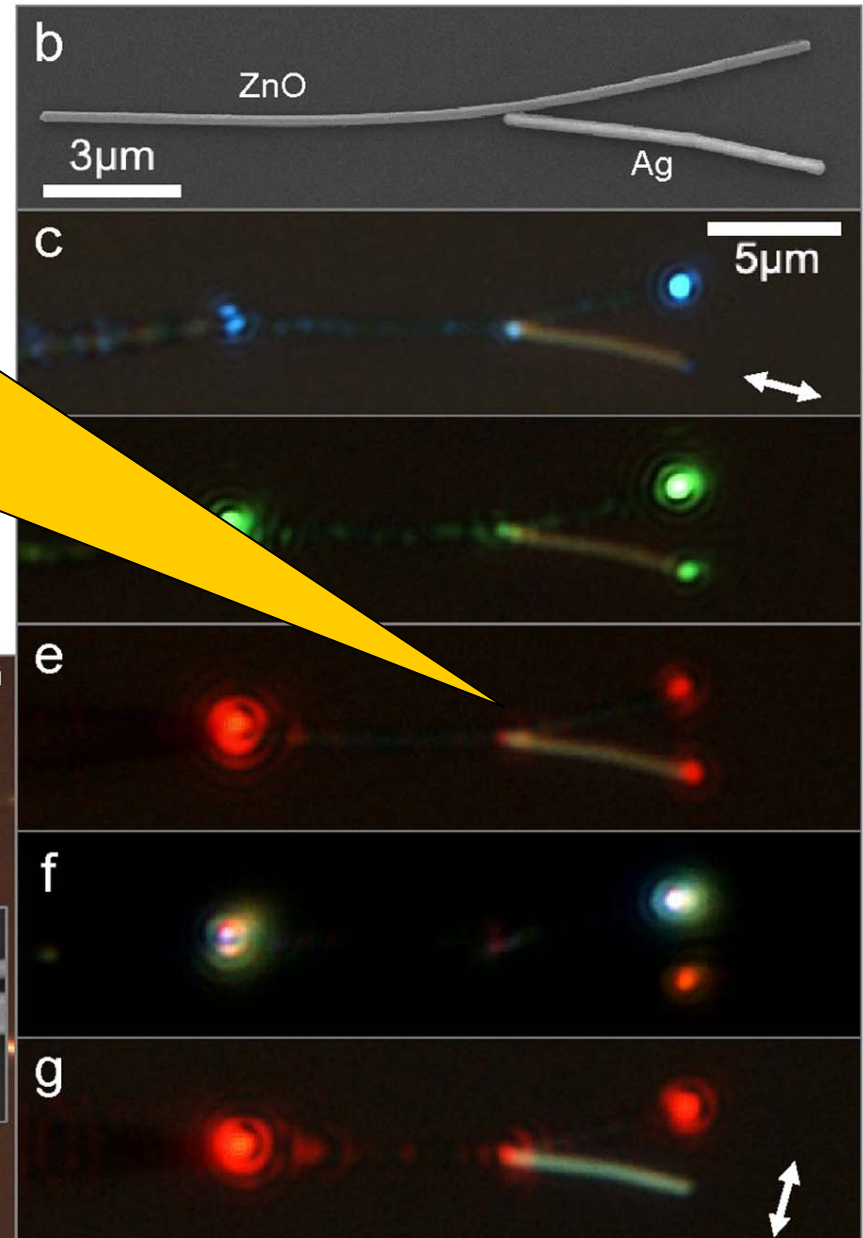

(2) Plasmonics

Hybrid nanowire resonators

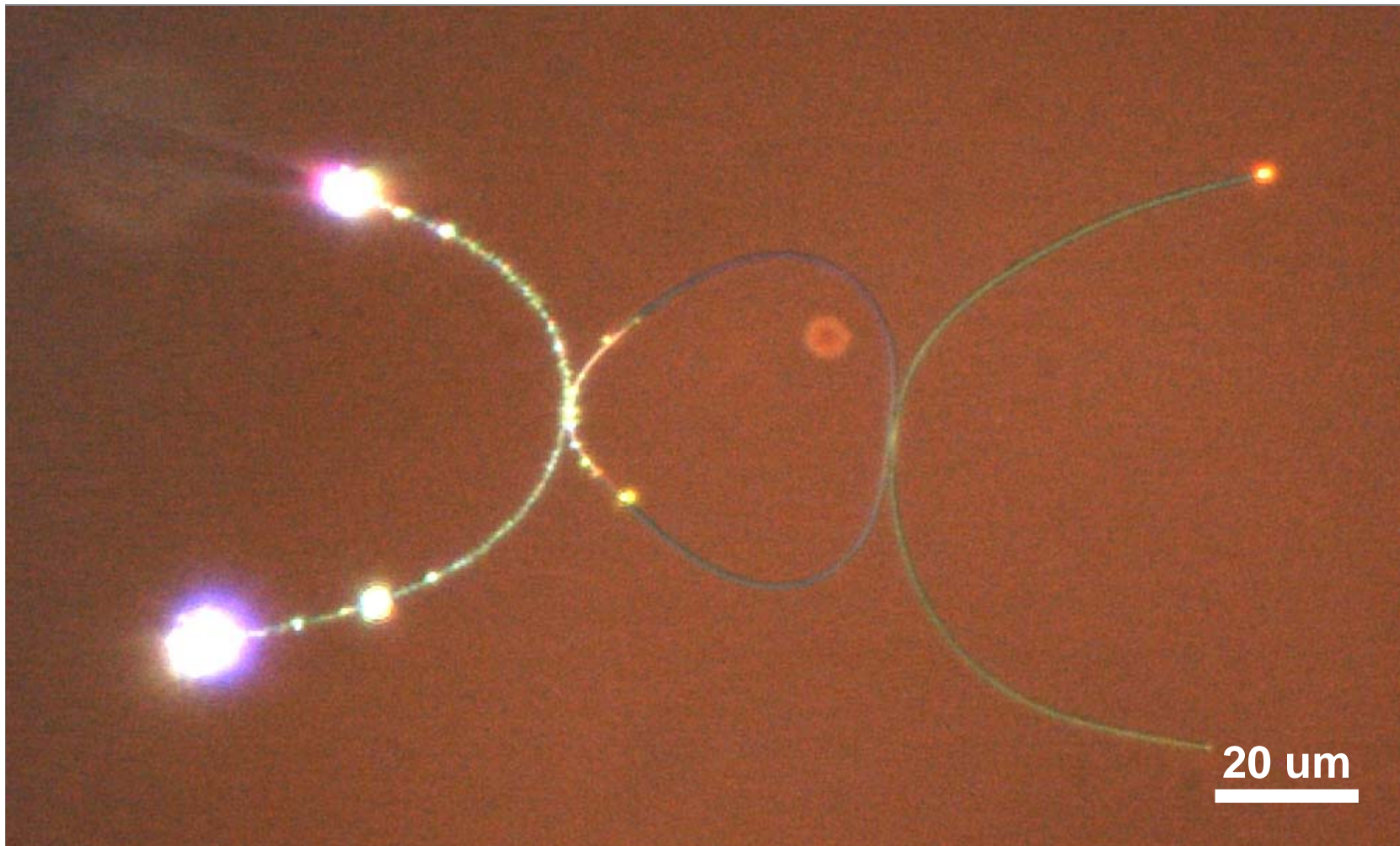

(2) Plasmonics

Hybrid nanowire resonators

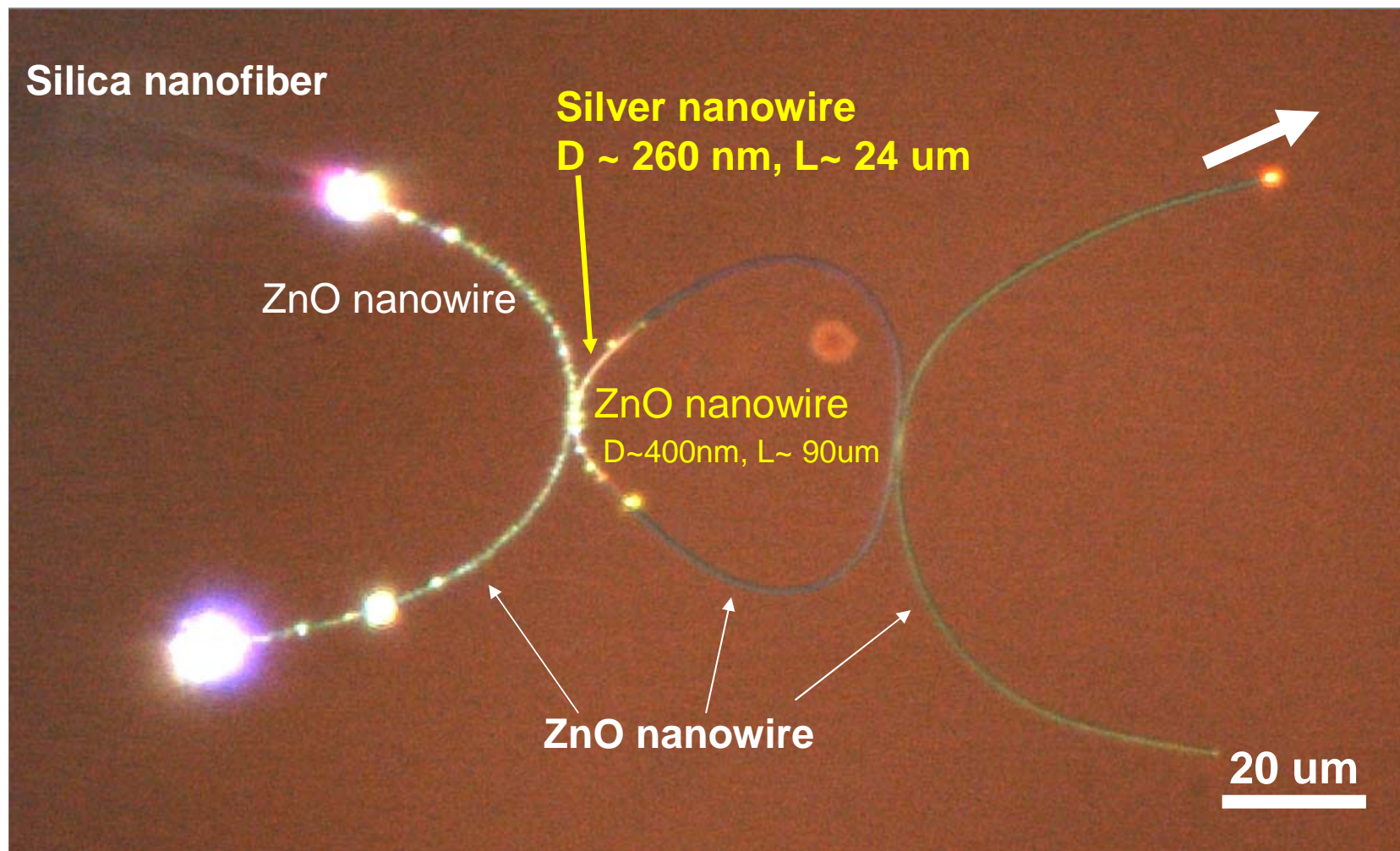

(2) Plasmonics

Hybrid nanowire resonators

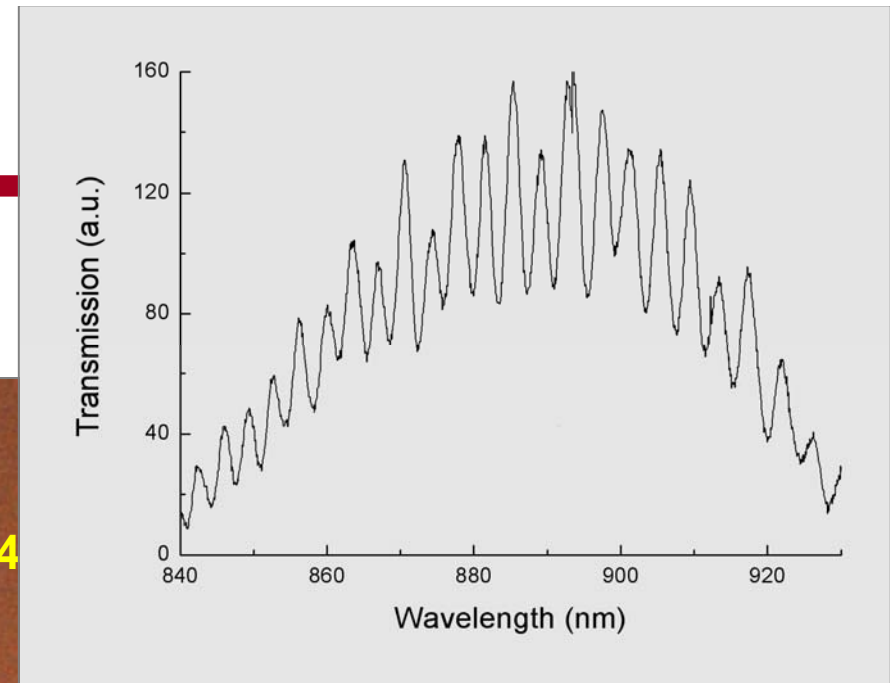
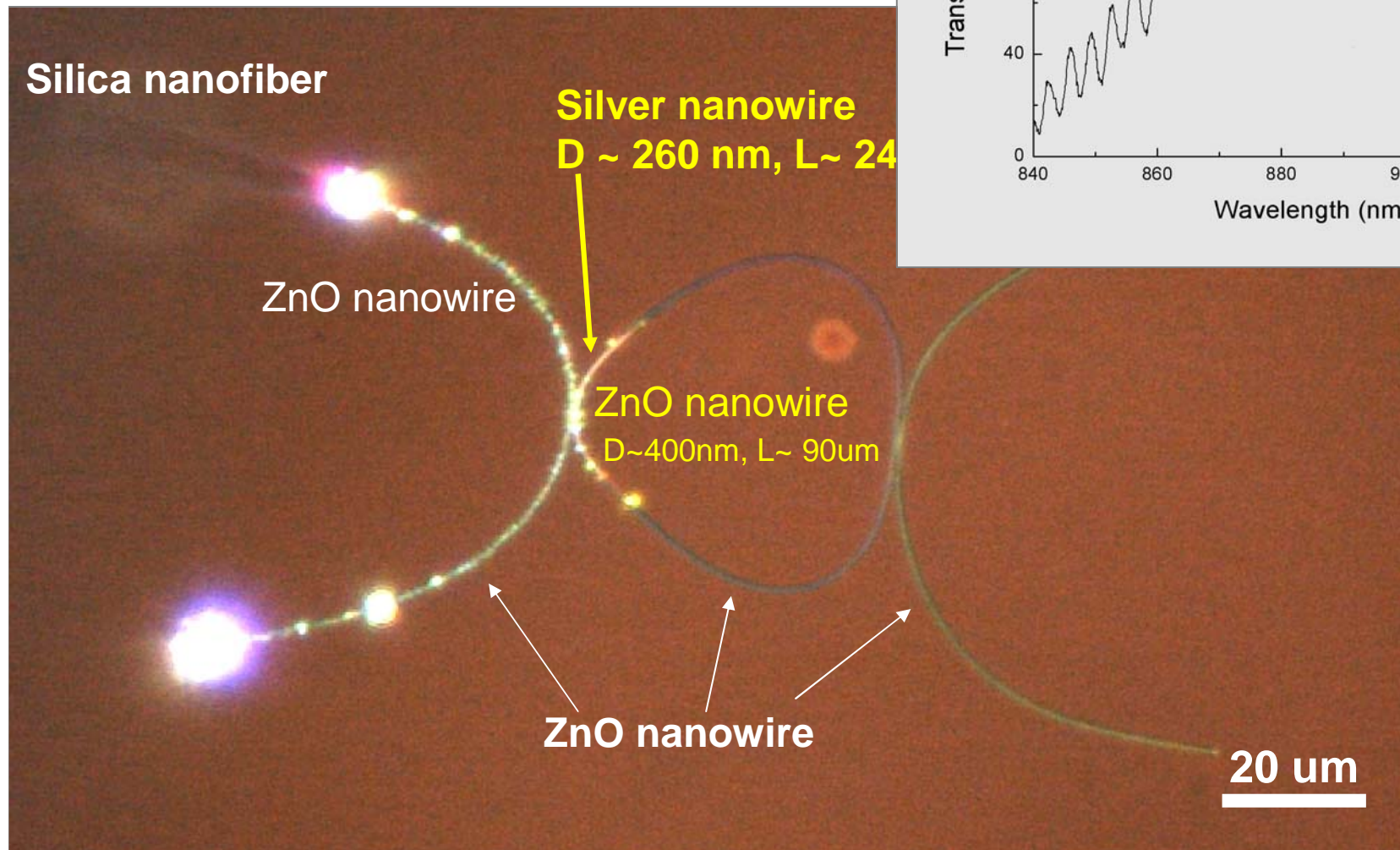

(2) Plasmonics

Hybrid nanowire resonators

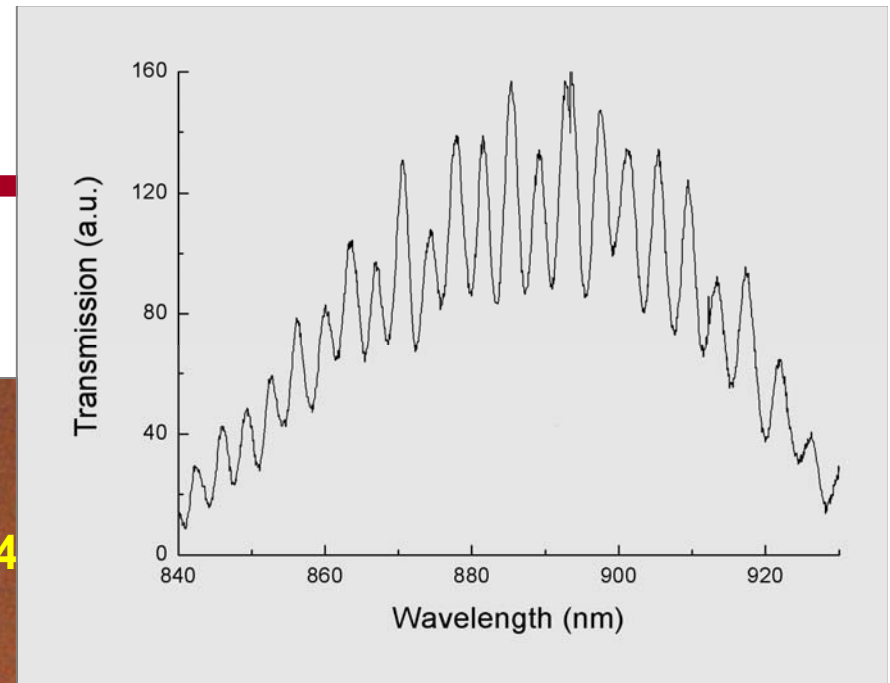
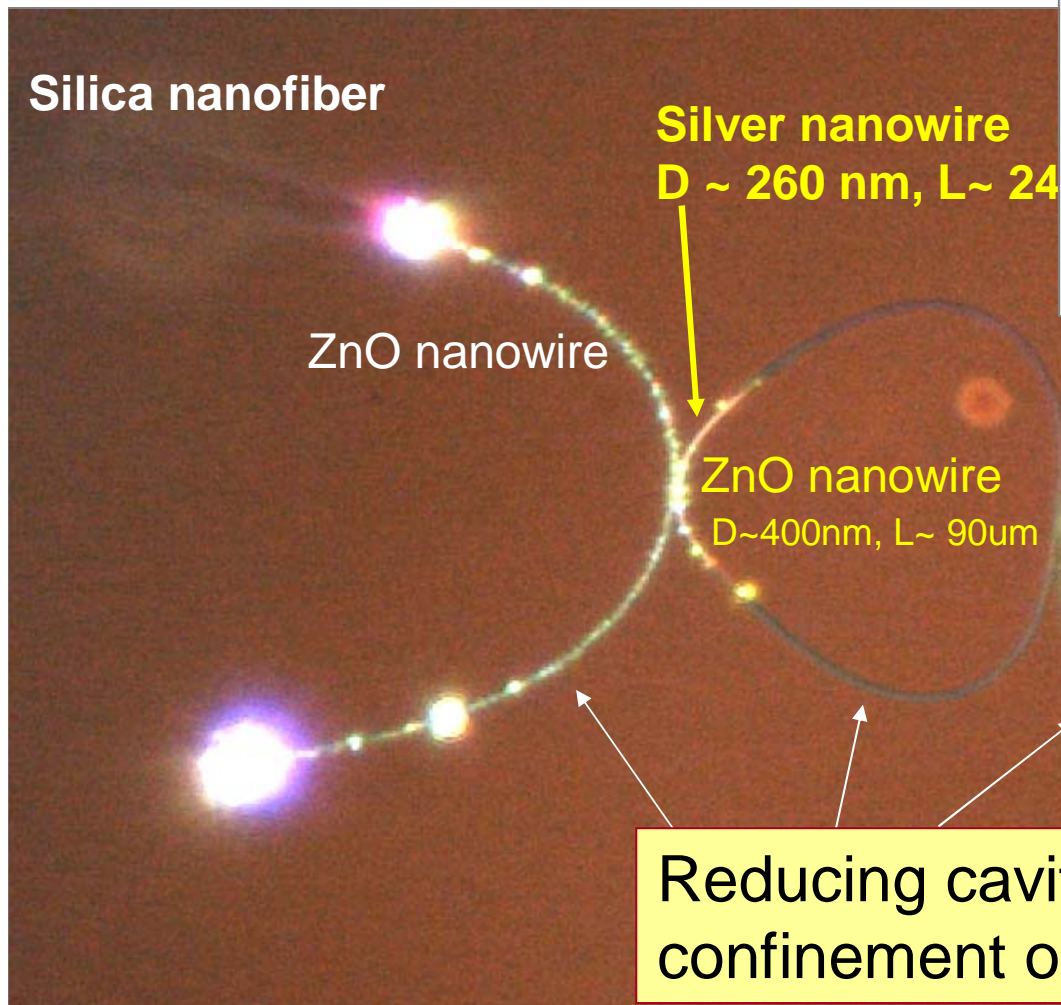

Q ~ 500
FSR = 3.8 nm

Reducing cavity loss without sacrificing confinement on the silver nanowire

Outline

Outline

3. Potentials and Applications

(1) Near-Field Optics

(2) Plasmonics

(3) Nonlinear Optics

(4) Quantum Optics\Atom Optics

(5) Photon Momentum

(3) Nonlinear Optics

2.2 Nanofibers for nonlinear optics

For nonlinear effects, nanofibers present advantages including:

- **Small mode area** : $D_{eff} < \lambda$
- **Effective nonlinearity** : $\gamma = (2\pi/\lambda)n_2/A_{eff} \rightarrow$ **Large γ**
- **Dispersion** : **Diameter-dependent** \rightarrow **manageable**

(3) Nonlinear Optics

2.2 Nanofibers for nonlinear optics

For nonlinear effects, nanofibers present advantages including:

- **Small mode area** : $D_{eff} < \lambda$
- **Effective nonlinearity** : $\gamma = (2\pi/\lambda)n_2/A_{eff} \rightarrow$ **Large γ**
- **Dispersion** : **Diameter-dependent** \rightarrow **manageable**

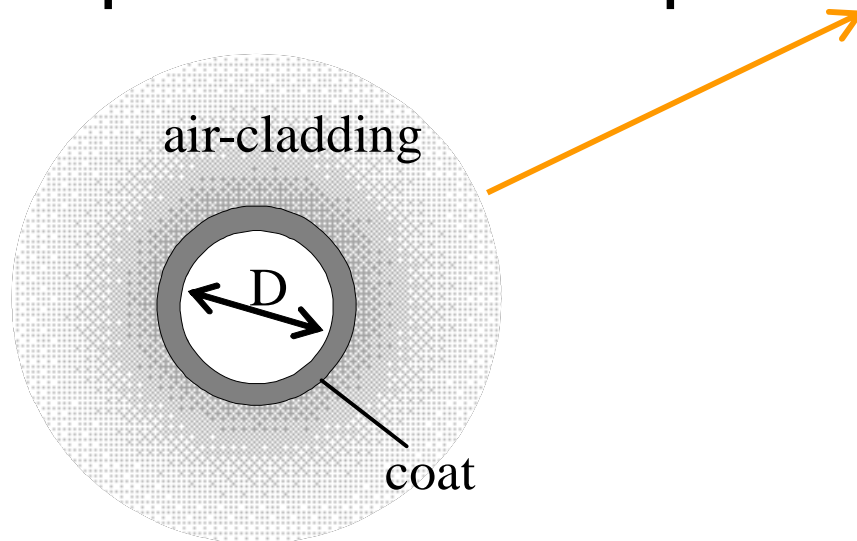

(3) Nonlinear Optics

2.2 Nanofibers for nonlinear optics

For nonlinear effects, nanofibers present advantages including:

- **Small mode area** : $D_{eff} < \lambda$
- **Effective nonlinearity** : $\gamma = (2\pi/\lambda)n_2/A_{eff} \rightarrow$ **Large γ**
- **Dispersion** : **Diameter-dependent** \rightarrow **manageable**

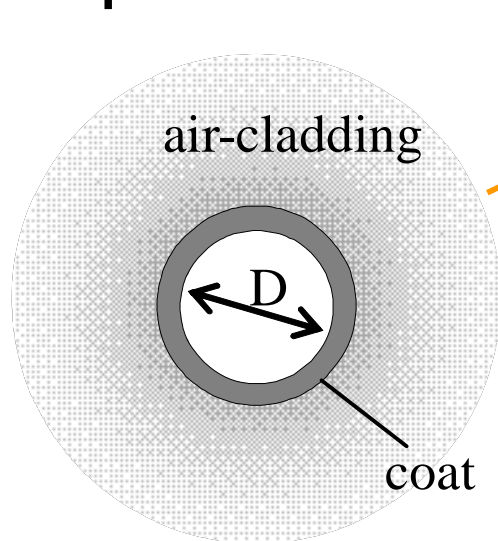

- **Low threshold**
- **Short interaction length**
- **possible to work with very small quantity of samples**

(3) Nonlinear Optics

2.2 Nanofibers for nonlinear optics

Diameter-dependent dispersion and nonlinearity of an air-cladding silica nanofiber at 800-nm wavelength

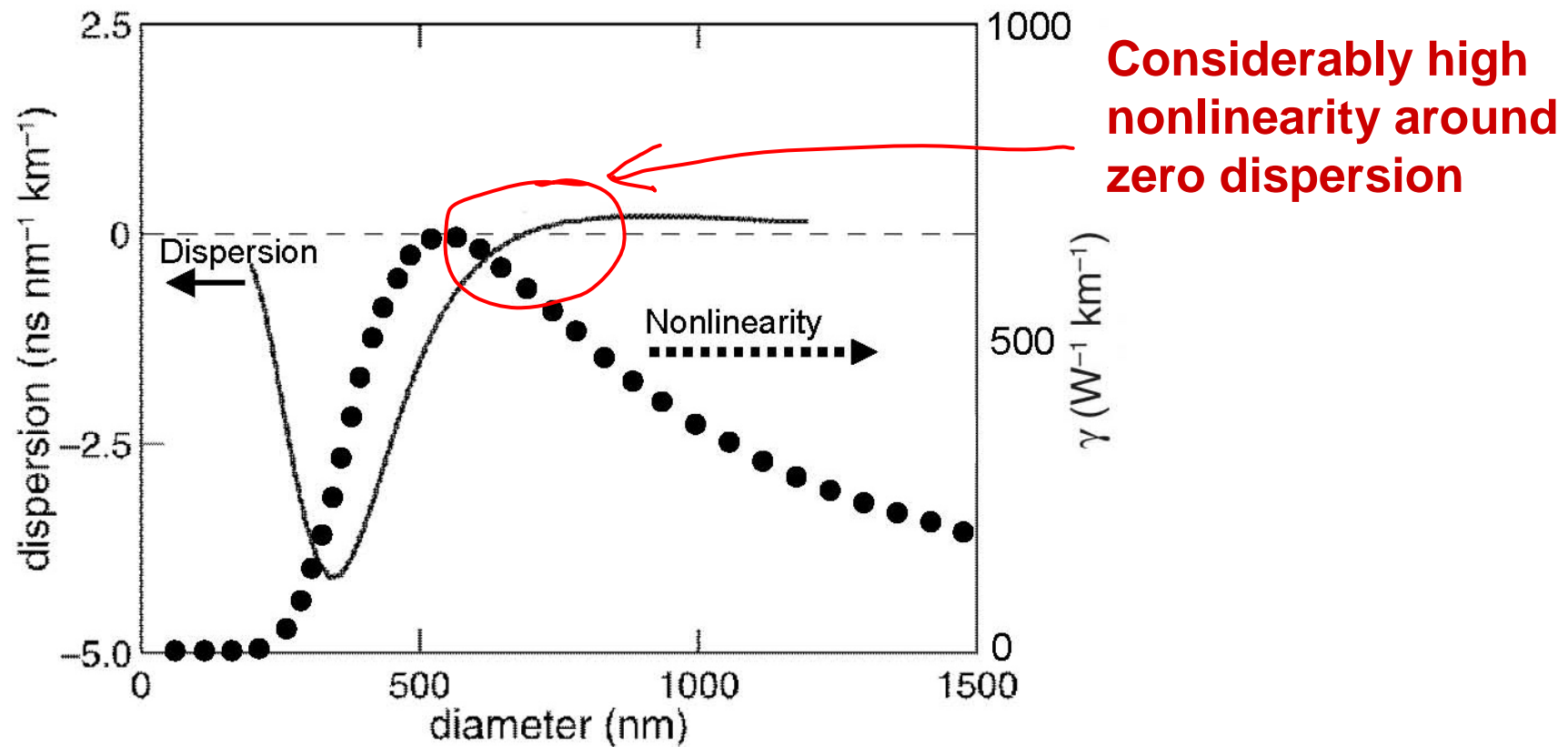

L. Tong et al., *Opt. Express* **12**,1025 (2004)

M. A. Foster et al., *Opt. Express* **12**, 2880 (2004)

Optical Nonlinearity in high nonlinear microfibers

Enhanced nonlinearity in sub-wavelength-diameter As_2Se_3 fibers

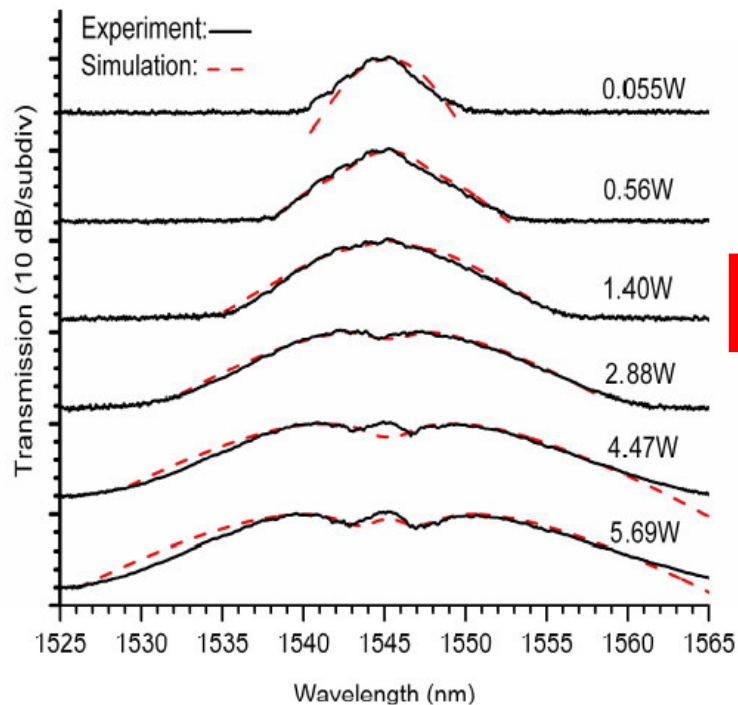
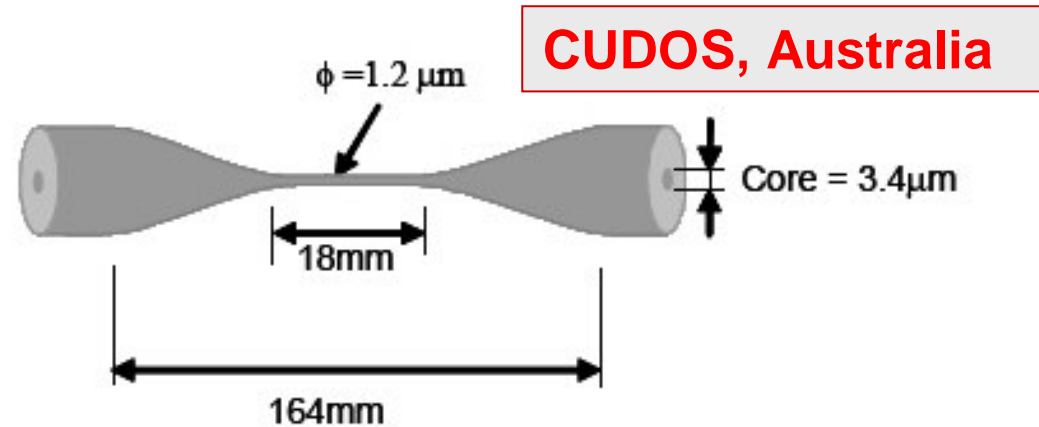

Enhanced nonlinearity of $68 \text{ W}^{-1}\text{m}^{-1}$

v.s. SMF28: $\gamma \sim 1 \times 10^{-3} \text{ W}^{-1} \text{ m}^{-1}$

62,000 times larger

(500 times larger n_2 and 125 times smaller effective mode area)

Fig. 5. SPM spectra under different incident peak power in the As_2Se_3 fiber

(3) Nonlinear Optics

Supercontinuum generation

- with ns pulses [12]

U Bath (UK)

Silica fiber

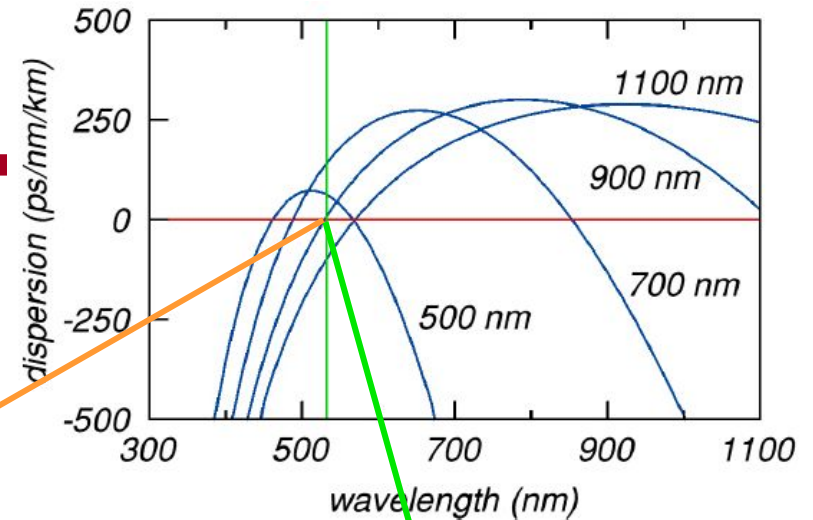
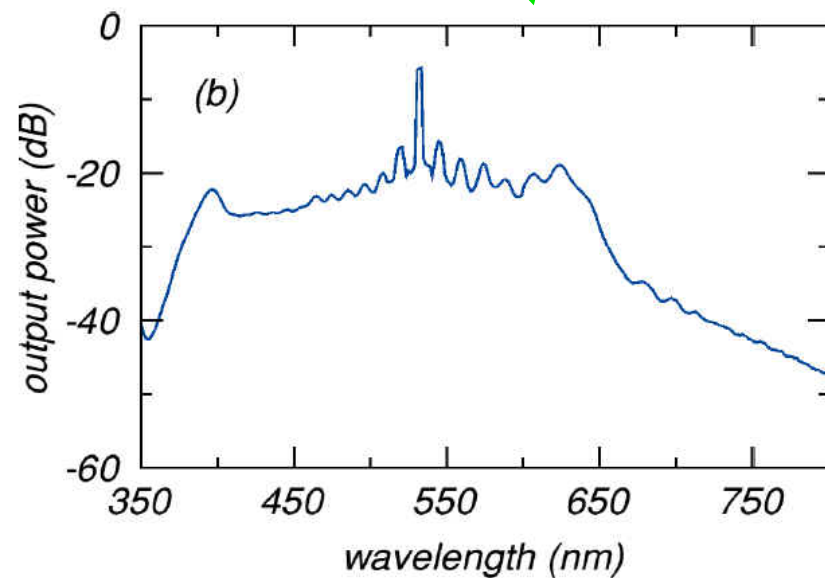
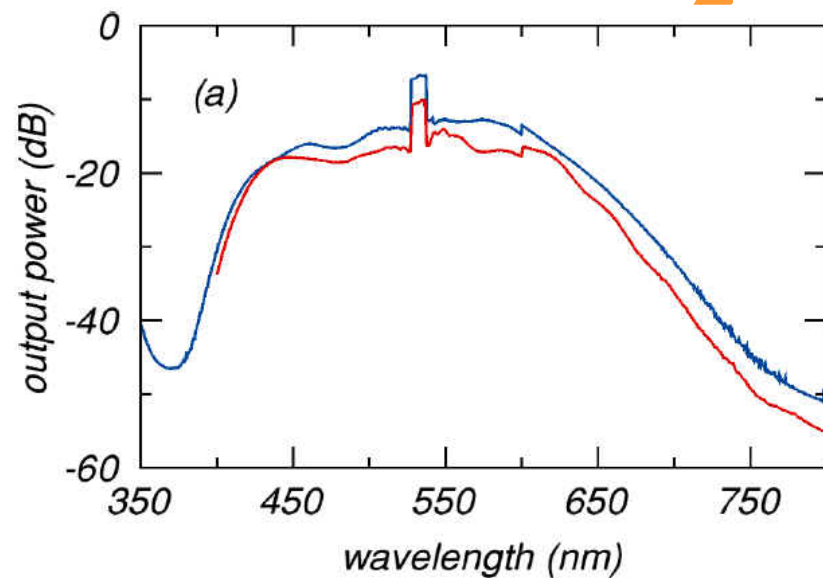

Fig. 4. SC spectra generated by taper waists for diameter, length and average laser power of (a) 920 nm, 90 mm and ~3 mW, and (b) 510 nm, 20 mm and ~1.5 mW, respectively. The red curve is for a sample made from Nufern 630-HP fibre instead of Corning SMF-28.

(3) Nonlinear Optics

2.3 Supercontinuum generation

- with fs pulses

Pumping light : $\lambda \sim 800$ nm, $\tau \sim 100$ fs

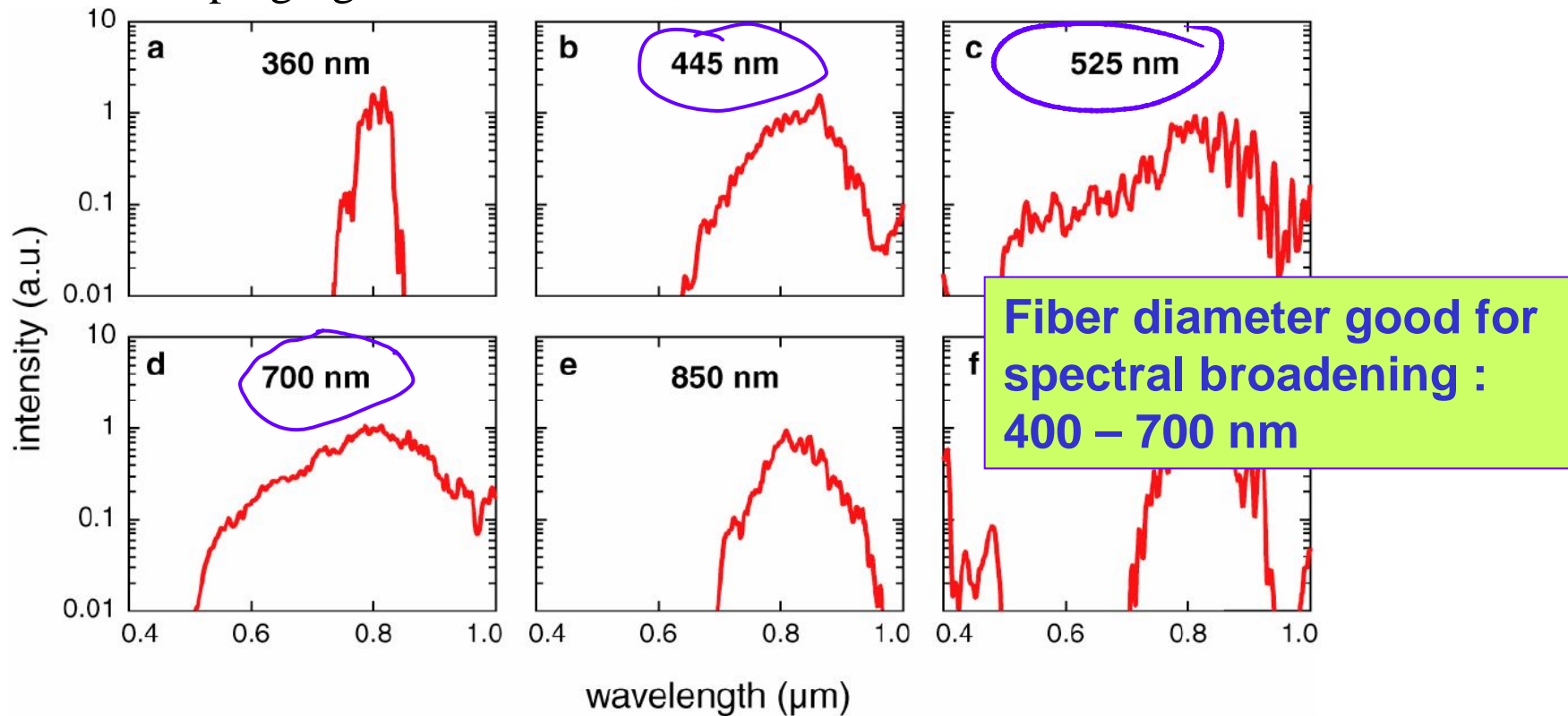

Fig. 2. Supercontinuum spectra for the six fibers of Fig. 1. The transmitted pulse energies are: (a) 0.3 nJ, (b) 4 nJ, (c) 6 nJ, (d) 4 nJ, (e) 7 nJ and (f) 2.5 nJ.

(3) Nonlinear Optics

2.4 More potentials and applications

Pulse compression

Two photon absorption

Enhanced Kerr nonlinearity

All-optical signal processing

Nonlinear interaction in atom vapor

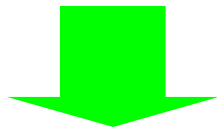

M. A. Foster et al., *Opt. Express* 13, 6848 (2005)

L. Shi et al., *Opt. Express* 14, 5055 (2006)

H. You et al., *Phys. Rev. A* 78, 053803 (2008)

E. C. Magi et al., *Opt. Express* 15, 10324 (2007)

M. D. Pelusi et al., *Opt. Express* 16, 1506 (2008)

M. A. Foster et al., *Opt. Express* 16, 1300-1320 (2008)

S. M. Spillane et al., *Phys. Rev. Lett.* 100, 233602 (2008)

Outline

3. Potentials and Applications

(1) Near-Field Optics

(2) Plasmonics

(3) Nonlinear Optics

(4) Quantum Optics\Atom Optics

(5) Photon Momentum

(4) Quantum Optics

2.5 Atom trap and manipulation

- Atom trap and guide using optical waveguides [15,16]

e.g. Hollow waveguide

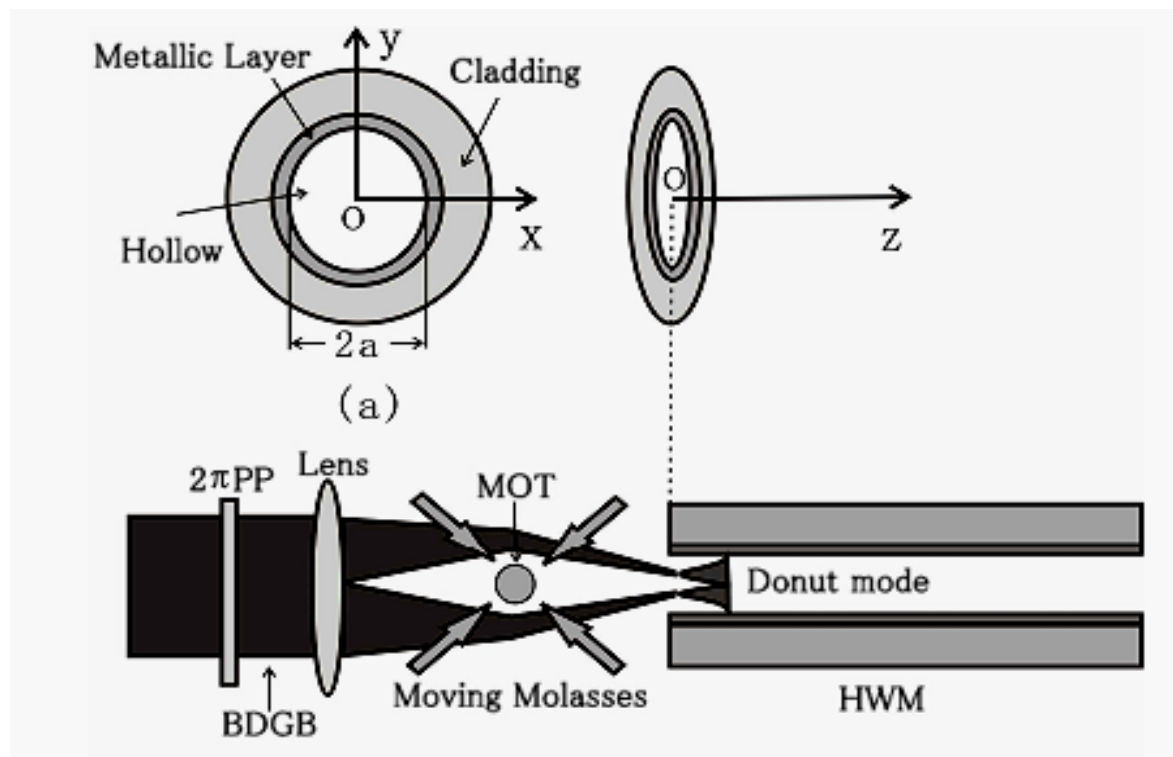

[15] A. H. Barnett *et al.*, *Phys. Rev.* **A61**, 023608 (2000)

[16] Z. Wang, *et al.*, *Opt. Express* **13**, 8406 (2005)

(4) Quantum Optics

2.5 Atom trap and manipulation

- Atom trap and guide using optical nanofiber [17-20]

U Electro-Communications (Japan)

Advantages

- **Deep potential for trapping/guiding of neutral atoms**
- **Trap atoms in open space outside the nanofiber**
- **Couple atom emission back into the nanofiber**

(4) Quantum Optics

2.5 Atom trap and manipulation

- Atom trap and guide using optical nanofiber [17-20]

U Electro-Communications (Japan)

Basic idea

Using the gradient force of a red/blue-detuned evanescent-wave to balance/serve as the centrifugal/centripetal force to store, move, and manipulate cold atoms in a controlled manner, and **this is possible only when $D_{\text{fiber}} < \sim \lambda / 2$**



Due to the spatial distribution of the evanescent fields of a nanofiber

[17] V. I. Balykin et al., *Phys. Rev.* **A70**, 11401 (2004)

[18] F. L. Kien et al., *Phys. Rev.* **A70**, 11401 (2004)

[19] F. L. Kien et al., *Phys. Rev.* **A73**, 13819 (2006)

[20] K. P. Nayak et al., *Opt. Express* **15**, 5431 (2007)

- Atom trap and guide using optical microfiber [18]

Two-color scheme

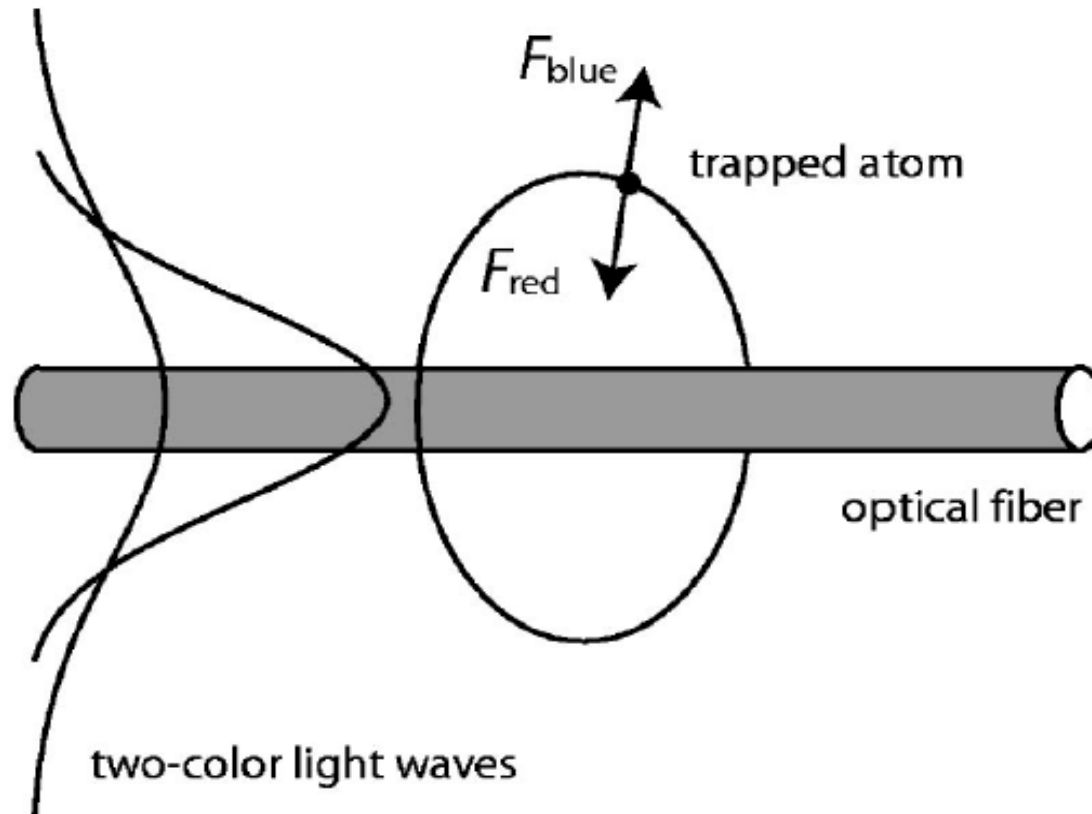

FIG. 1. Schematic of atom trapping and guiding around an optical fiber.

- Atom trap and guide using optical microfiber [18]

Two-color scheme

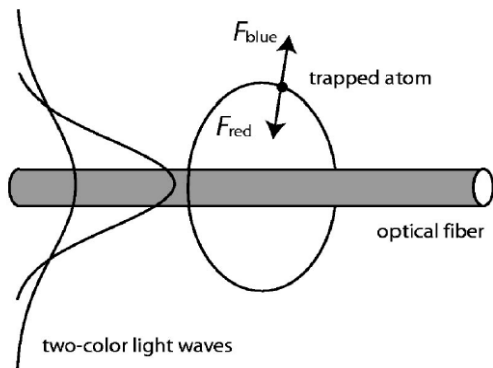
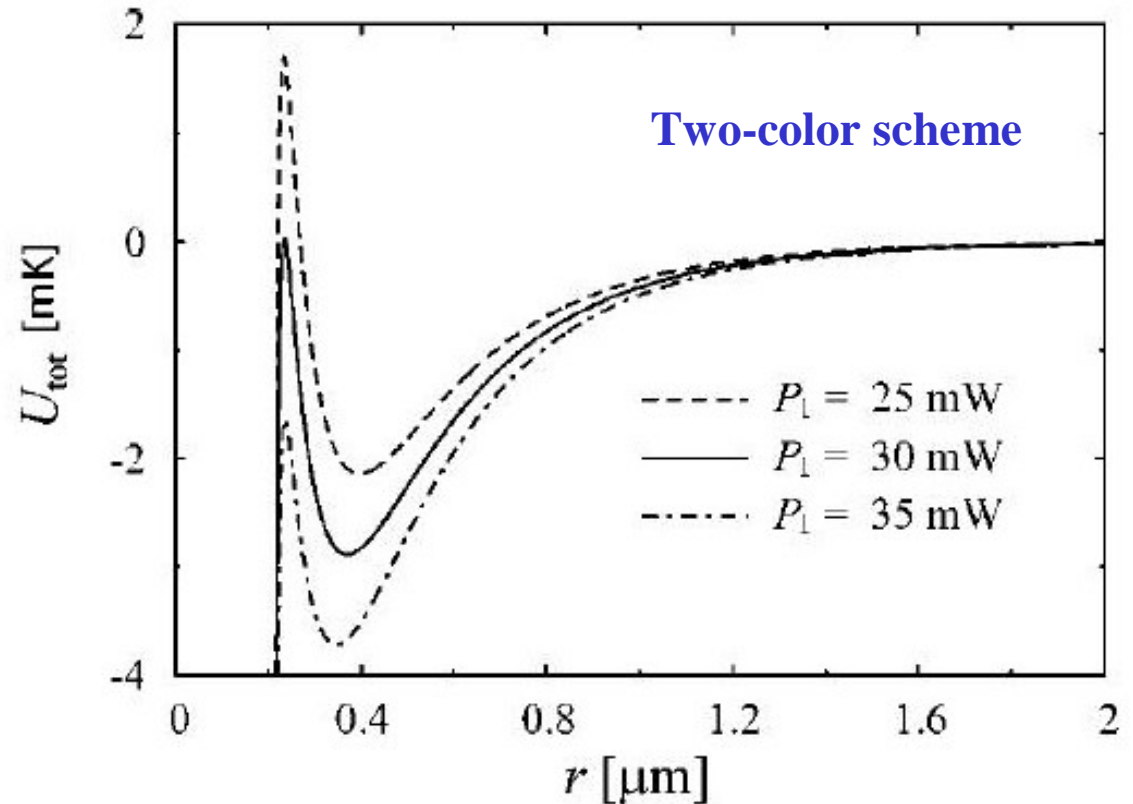

FIG. 1. Schematic of atom trapping and guiding around an optical fiber.



400-nm-diameter silica fiber, Cesium atom
 Red-detune: 30-mW 1.06- μm , $P_{\text{-Circular}}$
 Blue-detune: 29-mW 700-nm, $P_{\text{-Circular}}$

Trap depth $\rightarrow \sim 3 \text{ mK}$
 Coherence time $\rightarrow \sim 32 \text{ ms}$

$P_{\text{-Linear}} \rightarrow$ Linear trap is possible !

(4) Quantum Optics

2.6 Light-atom interaction without cavity

Small  **Tight confinement with small mode area**



Modify vacuum states around the nanofiber



Modify spontaneous
rate of an atom nearby



Couple distant atoms

(4) Quantum Optics

2.6 Light-atom interaction without cavity

Enhance spontaneous decay

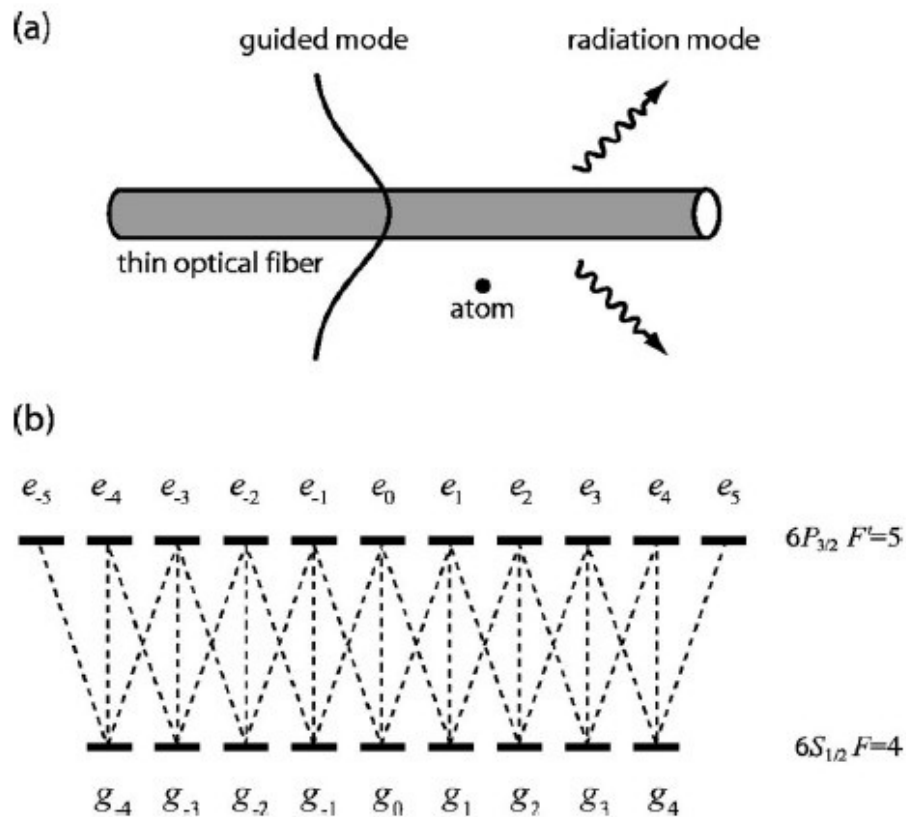

FIG. 1. (a) An atom interacting with guided and radiation modes in the vicinity of a thin optical fiber. (b) Schematic of the $6P_{3/2}F'=5$ and $6S_{1/2}F=4$ hfs levels of a cesium atom.

Modify vacuum modes
around the nanofiber

[21] Fam Le Kien et al., *Phys. Rev. A* **72**, 032509 (2005).

[22] G. Sague et al., *Phys. Rev. Lett.* **99**, 163602 (2007).

(4) Quantum Optics

2.6 Light-atom interaction without cavity

Enhance spontaneous decay

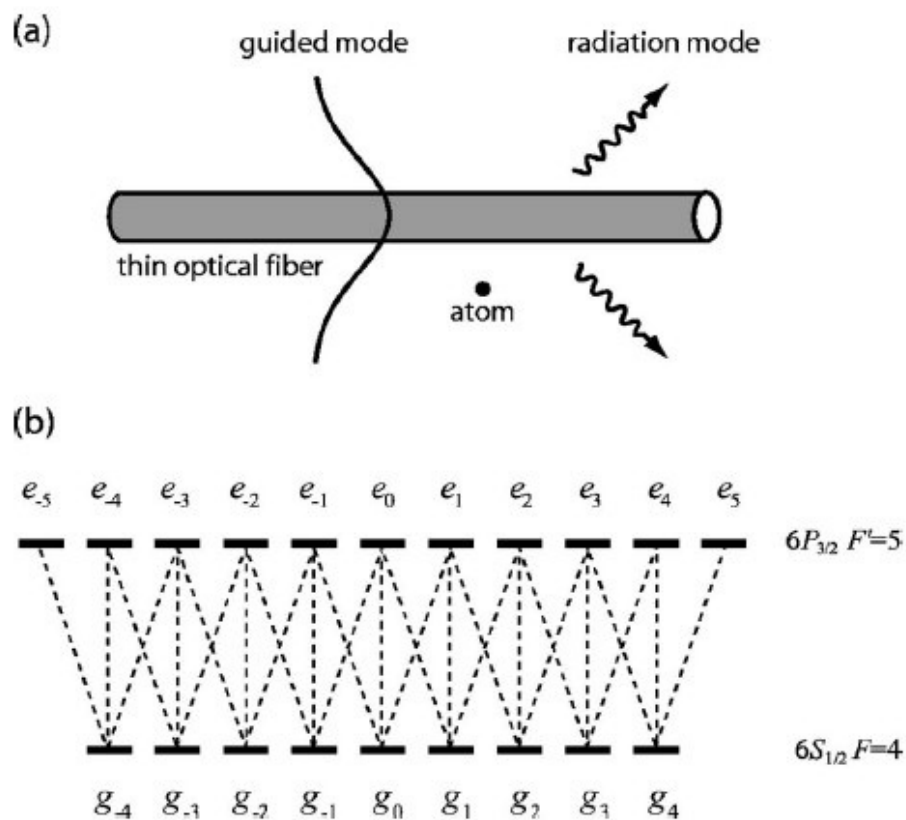

FIG. 1. (a) An atom interacting with guided and radiation modes in the vicinity of a thin optical fiber. (b) Schematic of the $6P_{3/2} F'=5$ and $6S_{1/2} F=4$ hfs levels of a cesium atom.

Theoretically proposed by researchers in Japan (U Electro-Communications) [21]

and experimentally observed by researchers in Germany (U of Bonn) [22]

Modify spontaneous rate without cavity !

[21] Fam Le Kien et al., *Phys. Rev. A* **72**, 032509 (2005).

[22] G. Sague et al., *Phys. Rev. Lett.* **99**, 163602 (2007).

Light-atom interaction without cavity

Couple two distant atoms through guided modes of a nanofiber

U Electro-Communications (Japan)

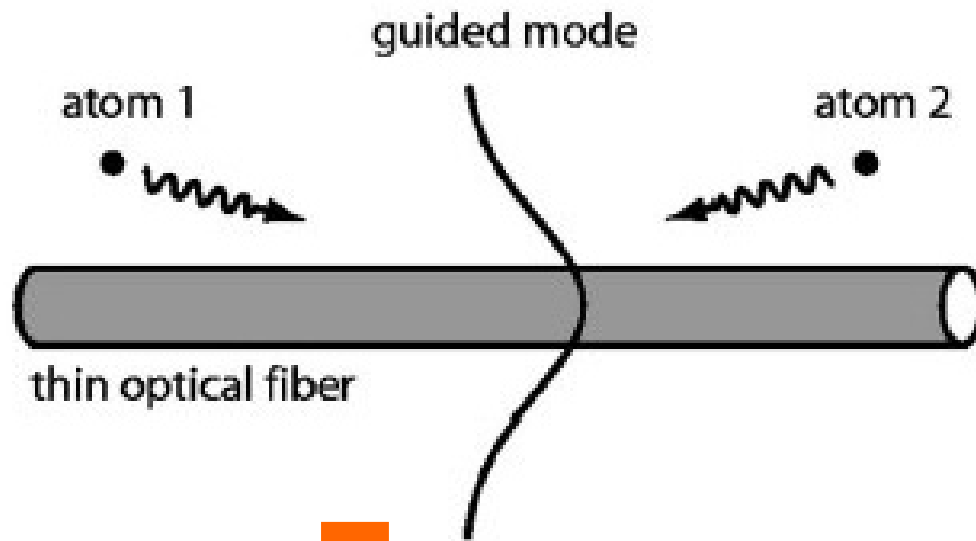

Radiative exchange between two distant atoms

Coupling two distant atoms

Quantum information



Nonradiative Förster energy transfer range ~ 10 nm

Outline

3. Potentials and Applications

(1) Near-Field Optics

(2) Plasmonics

(3) Nonlinear Optics

(4) Quantum Optics\Atom Optics

(5) Photon Momentum

(5) Photon Momentum

Feel momentum of light

Extremely light in mass



Weight & elastic bending force
of a silica nanofiber is comparable
to the force caused by
momentum change of light

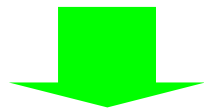

Feel the momentum of light
guided through

Sun Yat-Sen Univ (China) 中山大学

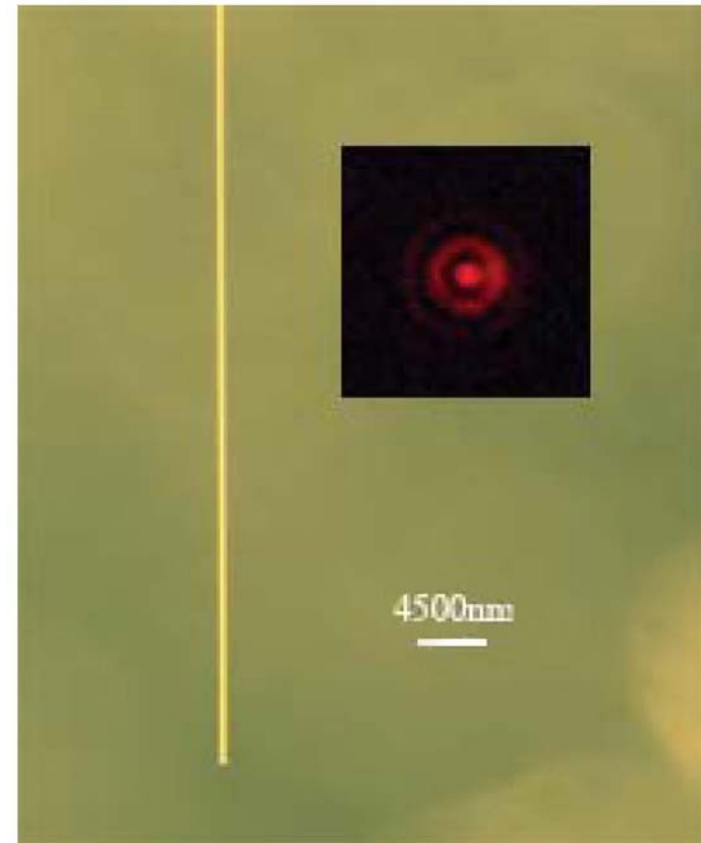

FIG. 1 (color online). The stationary micrograph of the tip of the SF, showing that the diameter of the SF tip is about 450 nm. The inset is the enlarged profile of a weak red light beam outgoing from the SF end face.

Focus needs your help: [Take the survey](#) and help us improve this site.

[Previous Story](#) / [Next Story](#) / [Volume 22 archive](#)

[Phys. Rev. Lett. 101, 243601](#)

(issue of 12 December 2008)

[Title and Authors](#)

10 December 2008

Light Bends Glass

Light gives a push rather than a pull when it exits an optical fiber, according to experiments reported in the 12 December *Physical Review Letters*.

The observations address a 100-year-old controversy over the momentum of light in a transparent material: Is it greater or smaller than in air? In the experiments, a thin glass fiber bends as light shines out the end, apparently a recoil in response to the light gaining momentum as it passes from glass to air. But the many experimental subtleties mean that the issue is unlikely to be settled soon.

Light moves slower inside a material than it does in air or vacuum. In 1908

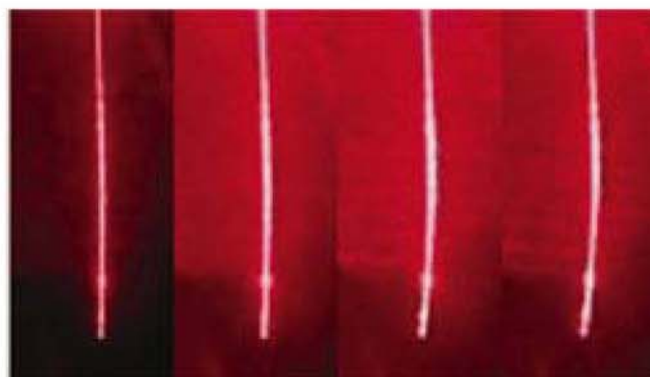

[Phys. Rev. Lett. 101, 243601 \(2008\)](#)

Recoil action. A thin glass fiber goes from straight (far left) to bent (far right) after a laser pulse shoots out the fiber's tip. The effect suggests that light gains momentum as it exits the fiber and supports one side in a century-long

Focus needs your help: [Take the survey](#) and help us improve this site.

[Previous Story](#) / [Next Story](#) / [Volume 22 archive](#)

[Phys. Rev. Lett. 101, 243601](#)

(issue of 12 December 2008)

[Title and Authors](#)

10 December 2008

Light Bends Glass

Light gives a push rather than a pull when it exits an optical fiber, according to experiments reported in the 12 December *Physical Review Letters*.

The observations address a 100-year-old controversy over the momentum of light in a transparent material: Is it greater or smaller than in air? In the experiments, a thin glass fiber bends as light shines out the end, apparently a recoil in response to the light gaining momentum as it passes from glass to air. But the many experimental subtleties mean that the issue is unlikely to be settled soon.

Light moves slower inside a material than it does in air or vacuum. In 1908

Observed a push force on the endface of a nanofiber exerted by outgoing light



Suggested Abraham's momentum in transparent dielectrics

$$P = E/(nc)$$

[Phys. Rev. Lett. 101, 243601 \(2008\)](#)

Recoil action. A thin glass fiber goes from straight (far left) to bent (far right) after a laser pulse shoots out the fiber's tip. The effect suggests that light gains momentum as it exits the fiber and suggests one side in a century-long

(5) Photon Momentum

Feel momentum of light

There was a debate on She's results [*PRL* 101, 243601(2008)], on the fractional momentum and mechanical momentum of photons [*PRL*103, 019301 (2009)].

(5) Photon Momentum

Feel momentum of light

There was a debate on She's results [*PRL* 101, 243601(2008)], on the fractional momentum and mechanical momentum of photons [*PRL*103, 019301 (2009)].



Lorentz force density $\mathbf{f} = (\mathbf{P} \cdot \nabla)\mathbf{E} + \frac{\partial \mathbf{P}}{\partial t} \times \mu_0 \mathbf{H}$

Longitudinal component $\mathbf{f}_z = (\mathbf{P} \cdot \nabla)\mathbf{E}_z + \left(\frac{\partial \mathbf{P}}{\partial t} \times \mu_0 \mathbf{H}\right)_z$

Mechanical momentum $\mathbf{p}_{\text{mech}}^z = \Delta v \int_0^T \mathbf{f}_z dt$

For continuous wave $\mathbf{p}_{\text{mech}}^z = 0$
 $P^z/P > 90\%$

(5) Photon Momentum

Feel momentum of light

There was a debate on She's results [*PRL* 101, 243601(2008)], on the fractional momentum and mechanical momentum of photons [*PRL*103, 019301 (2009)].



Lorentz force density $\mathbf{f} = (\mathbf{P} \cdot \nabla)\mathbf{E} + \frac{\partial \mathbf{P}}{\partial t} \times \mu_0 \mathbf{H}$

Longitudinal component $\mathbf{f}_z = (\mathbf{P} \cdot \nabla)\mathbf{E}_z + \left(\frac{\partial \mathbf{P}}{\partial t} \times \mu_0 \mathbf{H}\right)_z$

Mechanical momentum $\mathbf{p}_{\text{mech}}^z = \Delta v \int_0^T \mathbf{f}_z dt$

For continuous wave 

$$p_{\text{mech}}^z = 0$$

$$P^z/P > 90\%$$

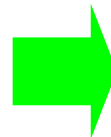

Support She's results and Abraham's momentum

Outline

- Introduction

1. Fabrication

2. Optical Properties

3. Potentials and Applications

- Summary

Summary

High-uniform glass microfibers and nanofibers can be fabricated using taper-drawing technique.



These fibers present interesting properties that may not exist in conventional optical fibers.

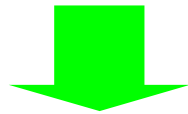

They are promising for connecting fiber optics with near-field optics, nonlinear optics, and quantum optics on the micro/nanoscale, and bringing new opportunities for both fundamental research and technological applications.

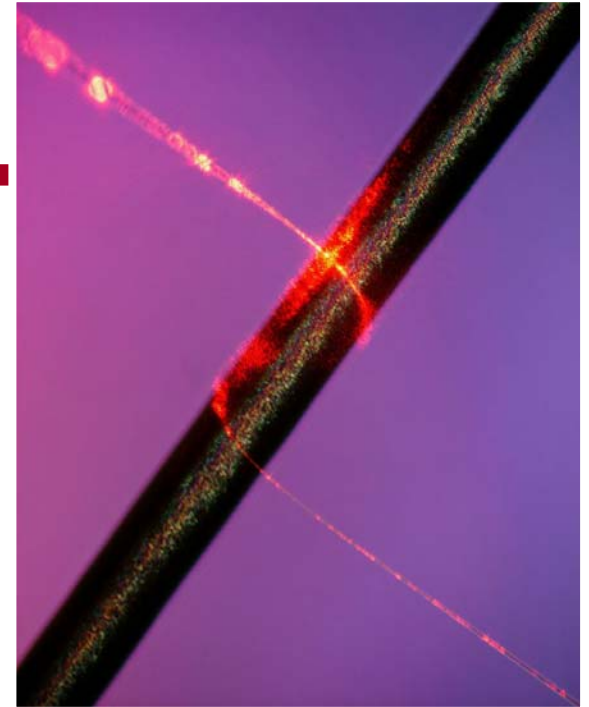

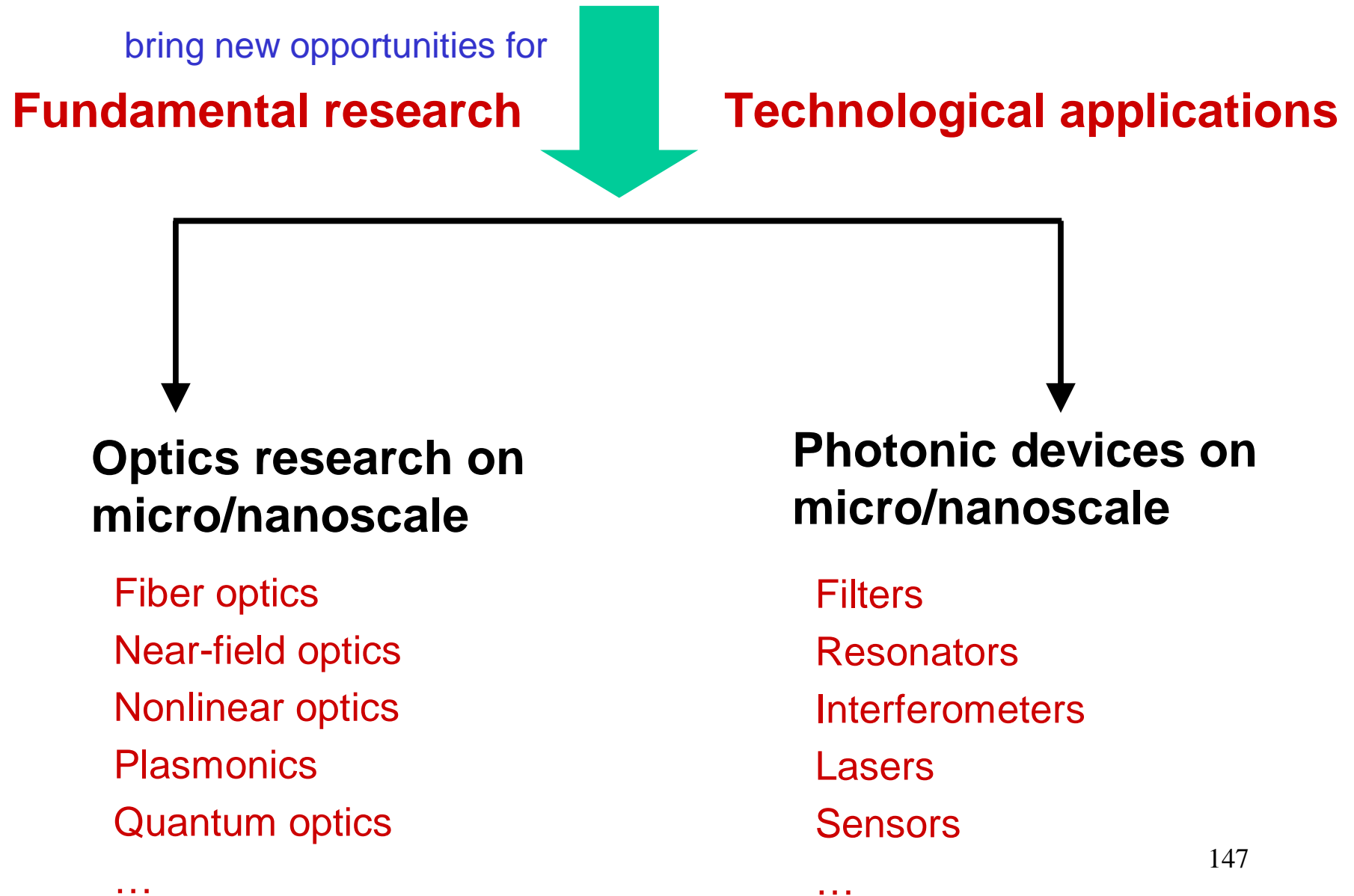

Shrink optical fibers to wavelength/ subwavelength scale



Summary

For more details:

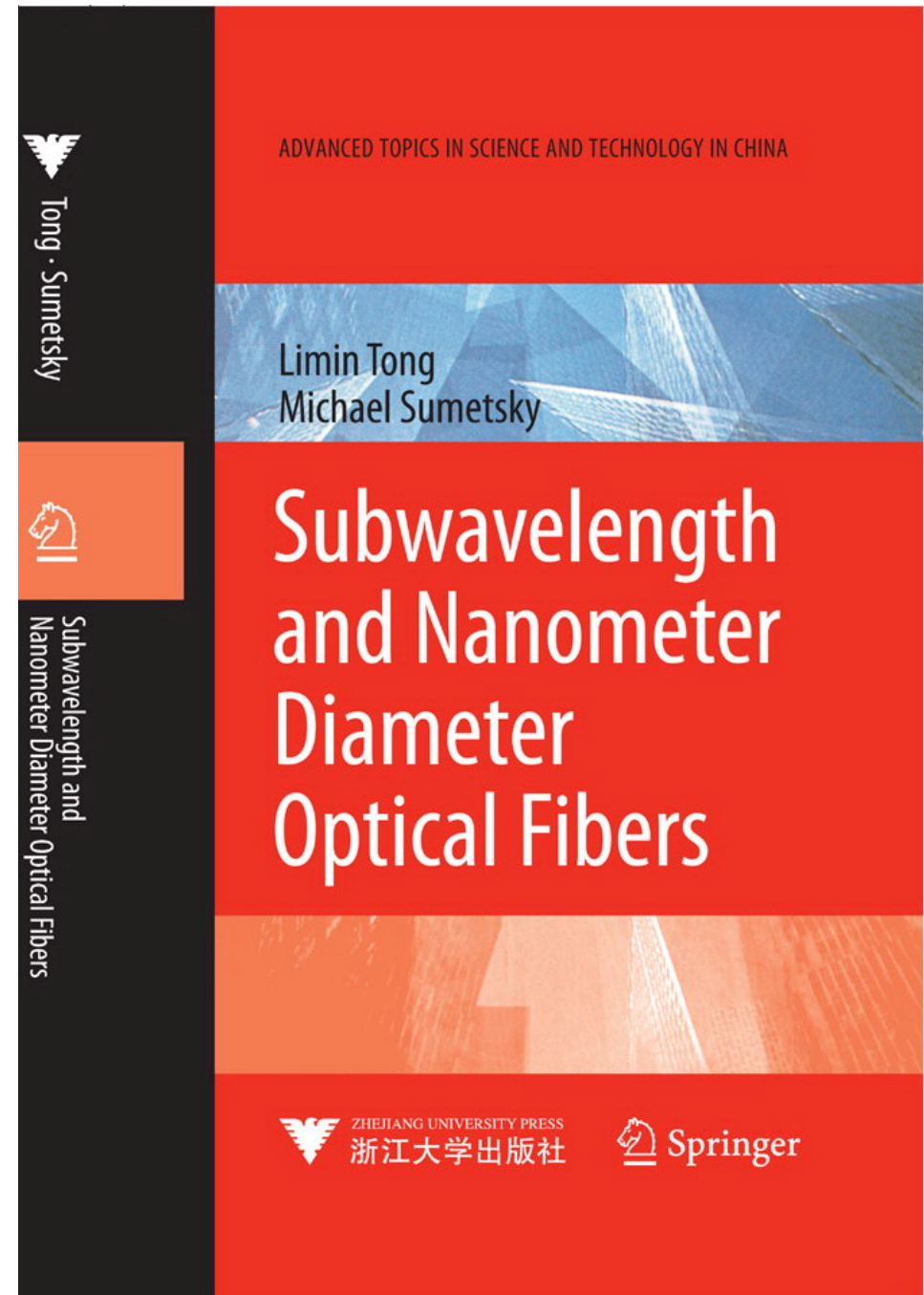
Limin Tong, Michael Sumetsky,
*Subwavelength and Nanometer
Diameter Optical Fibers*, Zhejiang
University Press, Springer, 2009.



Acknowledgement

Zhejiang University (China)

Jingyi Lou, Qing Yang, Guillaume Vienne, Yuhang Li, Zhe Ma, Xiaoshun Jiang, Xin Guo, Jianrong Qiu, Sailing He, Liu Liu, Xuewen Chen, Zhanghua Han

Harvard University (USA)

Eric Mazur, Rafael R. Gattass, Mengyan Shen, Geoffry T. Svacha, Yuan Lu, Jonathan B. Ashcom

SIOM (China)

Lili Hu, Junjie Zhang

Fudan Univ (China)

Lei Xu

University of Houston (USA)

Jiming Bao

KTH (Sweden)

Min Qiu

Acknowledgement

National Science Foundation of China (NSFC)

National Basic Research Program (973) of China

National Science Foundation of USA (NSF)

**Center for Imaging and Mesoscale Structures (CIMS)
@ Harvard University**

Acknowledge colleagues and students



Our Group at Zhejiang University

www.nanophotonics.zju.edu.cn

Thank you