

# Femtosecond laser induced functional microstructures in glass

Jianrong Qiu (邱建荣)

Photonic Materials Lab.

Zhejiang University, Hangzhou

China

Jan. 11th, 2010

Yuquan, Campus

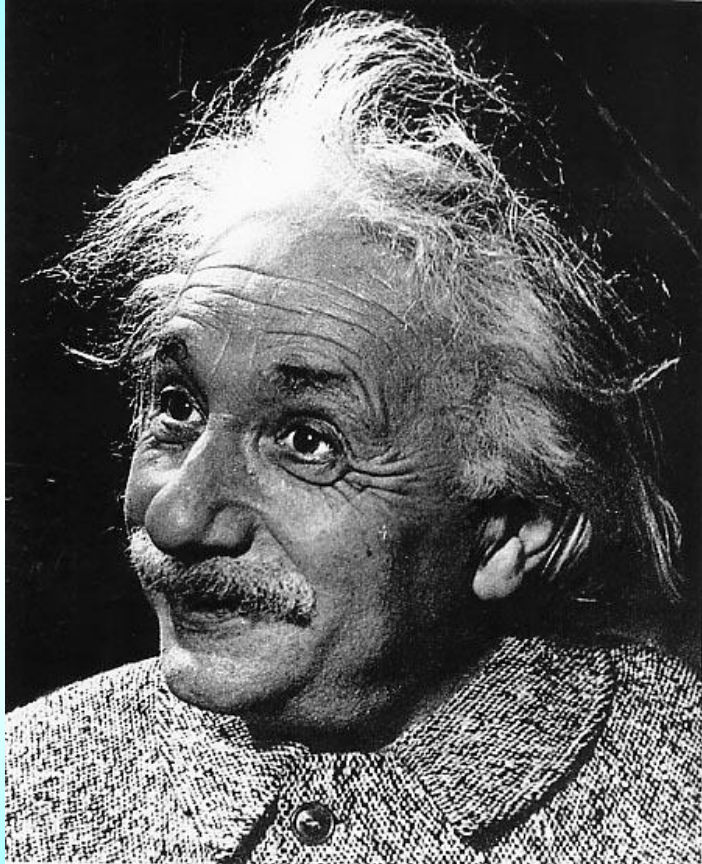

*"Imagination is more  
important than knowledge"*

*Albert Einstein*

# Outline

- 1、Fs laser and its features**
- 2、Mechanisms about fs laser interaction with matter**
- 3、Fs laser induced micro-structures in glass and their applications, and fs laser induced phenomena**
- 4、Conclusion**

# **Two greatest theories in the last century (in the field of science and technology)**

**quantum mechanics**

**量子力学**

**量子力学**

**is a set of scientific principles describing the known behavior of energy and matter that predominate at the atomic scale.**

**special relativity**

**狭义相对论**

**狭義相對論**

**is a physical theory of measurement in inertial frame of reference**

# Four greatest inventions in the last century



**Atomic  
energy**

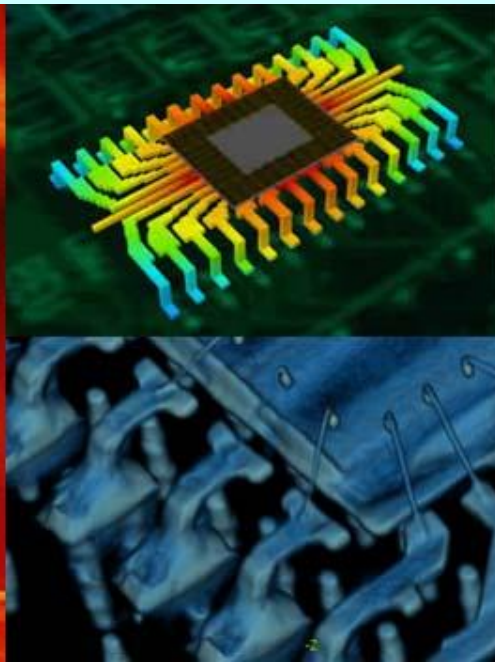

**Semiconductor**



**Computer**

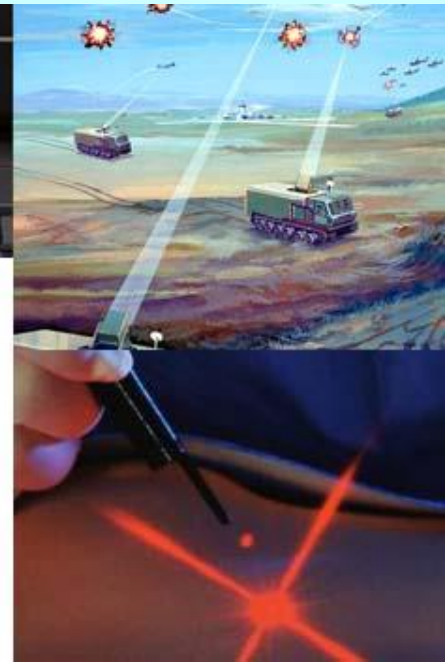

**Laser**

# What is laser?

Light amplification by stimulated emission of radiation

激光 雷射(thunder and lightning radiation)

レーザー

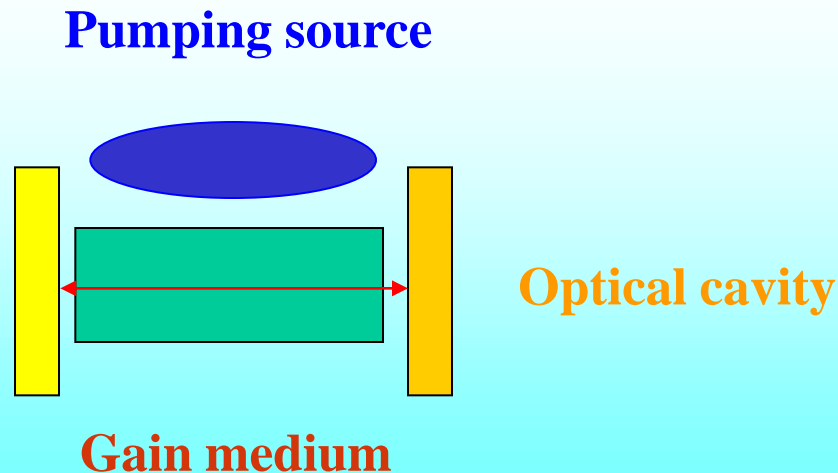

# Feature of laser

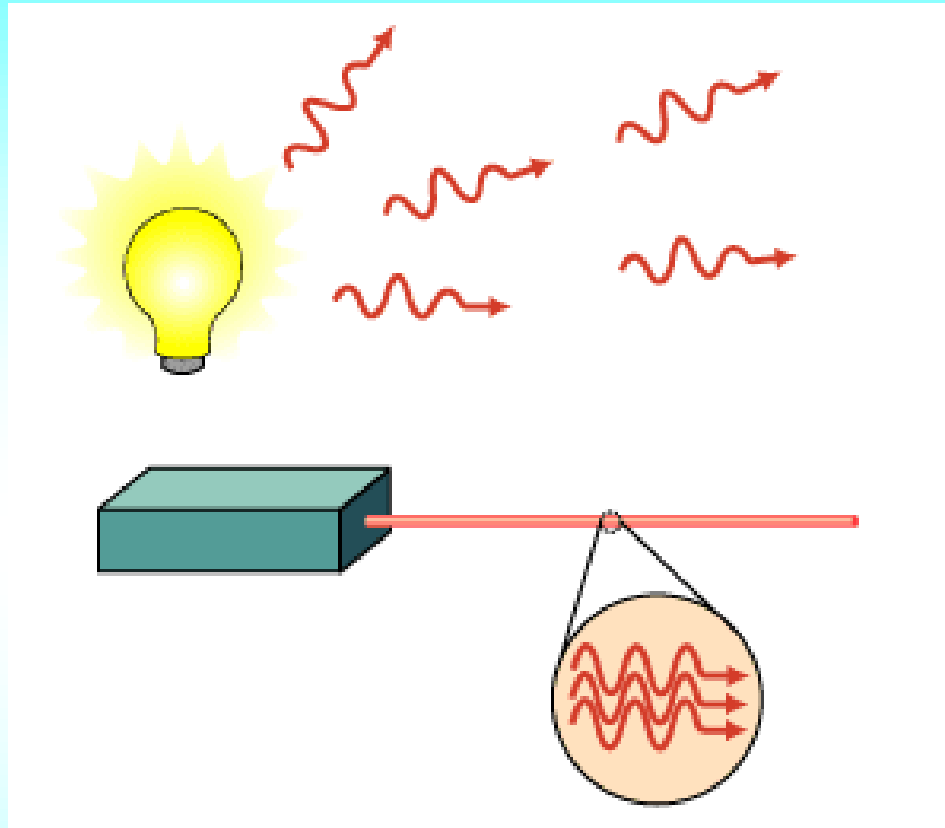

**Monochromatic ( $10^{-10}\text{m}$ ) , Narrow beam divergence**

**High brightness ( $4 \times 10^{13}\text{cd/m}^2$ ,  $1.7 \times 10^9\text{cd/m}^2(\text{sun})$ )**

**Coherent**

# **Nobel prize winners for laser**



**Towens, Prokhorov and Basov**

**for their works in the field of the maser and the laser**

**(1964)**



# First Laser

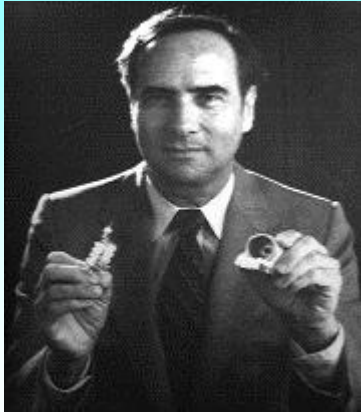

**Maiman (1960)**

**Ruby Laser**

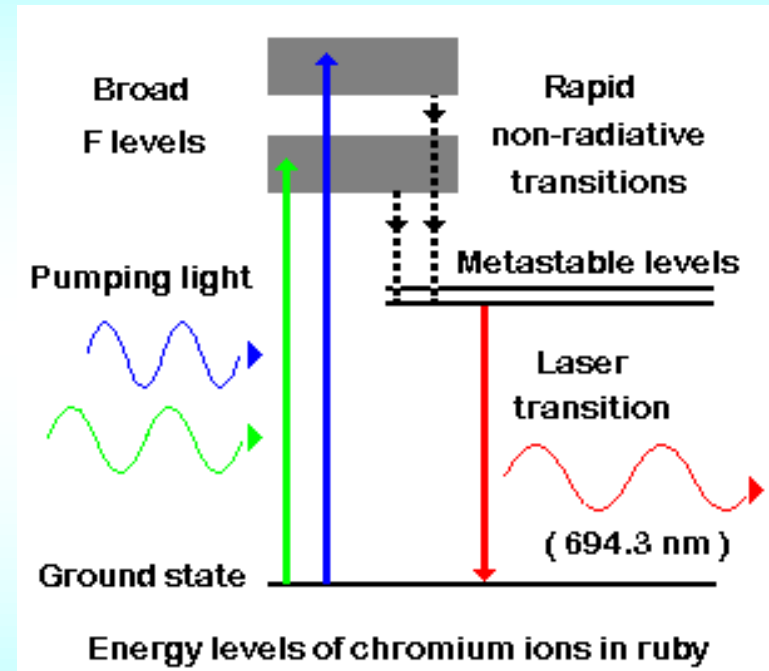
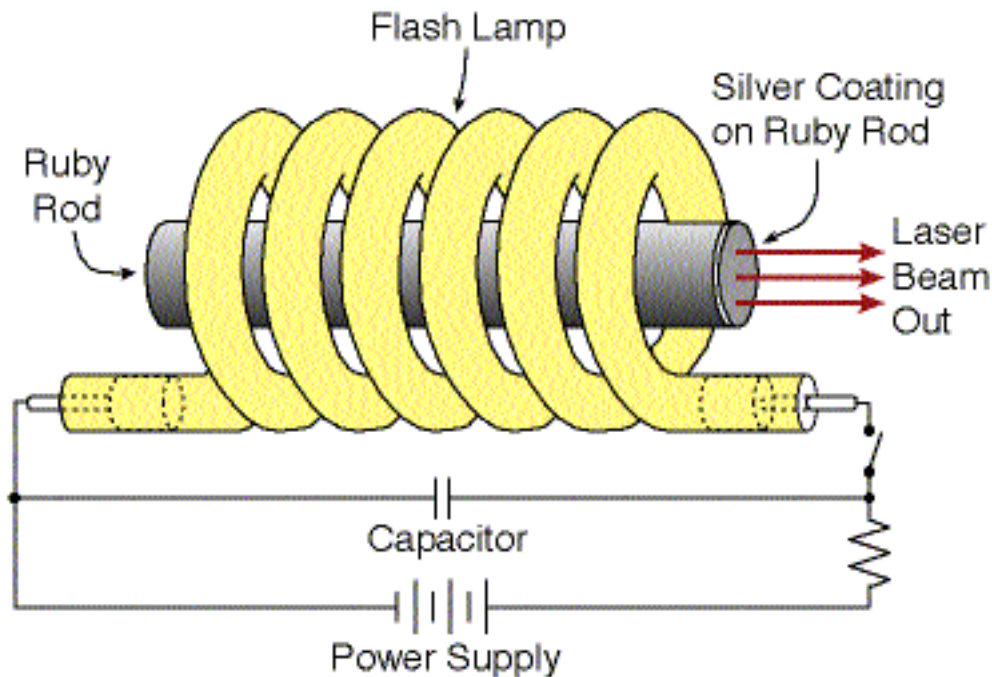



**LD**

**Gas laser ( CO<sub>2</sub>, Ar, Excimer )**

**Liquid laser (dye)**

**Solid State laser ( Crystal , glass )**

**Free-electron laser**

**etc.**

**CW laser**

**Pulsed laser**

# What is femtosecond laser?

$$1\text{fs}(\text{飞秒})=10^{-15}\text{s}$$

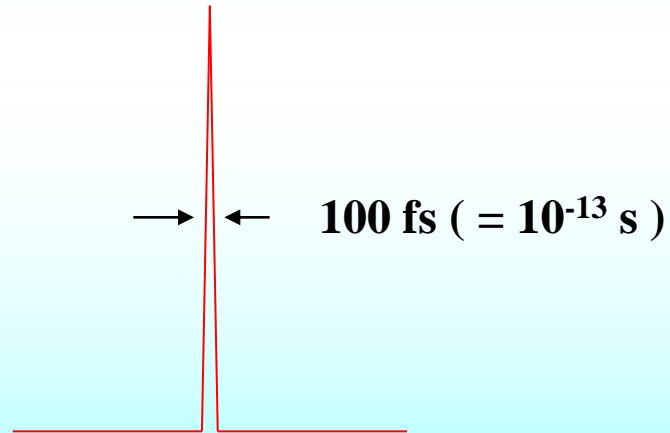

# Femtosecond laser system



**Spectral-physics Co. Ltd**

# How to realize a femtosecond pulse?

**Mode-locking:**      *Appl. Phys. Lett. 38(1981)671.*

R. L. Fork, B. I. Green and C. V. Shank (Bell Lab.)

CPM (Collision pulse mode-locking)    90fs pulse train

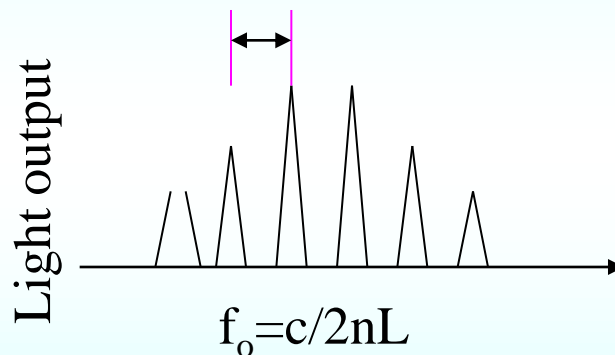

The basis of the technique is to induce a fixed phase relationship between the modes of the laser's resonant cavity. The laser is then said to be *phase-locked* or *mode-locked*. Interference between these modes causes the laser light to be produced as a train of pulses. Depending on the properties of the laser, these pulses may be of extremely brief duration, as short as a few femtoseconds.

# How to realize a femtosecond laser pulse with high energy?

**CPA (Chirped pulse amplification):** *Opt. Commun. 56(1985)219.*

D. Strickland and G. Mourou (Univ. Rochester)

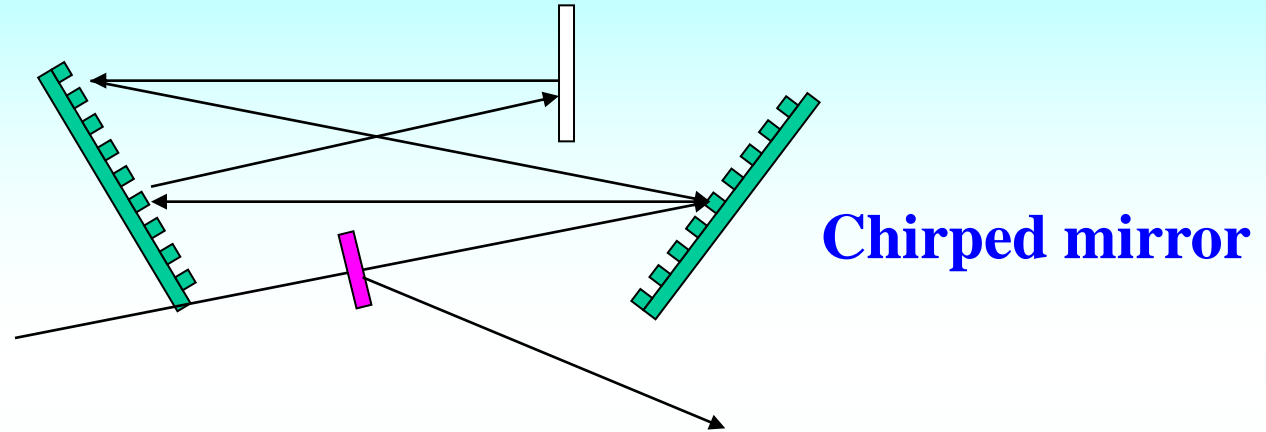

An ultrashort laser pulse is stretched out in time prior to introducing it to the gain medium using a pair of grating that are arranged so that the low-frequency component of the laser pulse travels a shorter path than the high-frequency component does. After going through the grating pair, the laser pulse becomes positively chirped, that is, the high-frequency component lags behind the low-frequency component, and has longer pulse duration than the original by a factor of 10<sup>3</sup> to 10<sup>5</sup>.

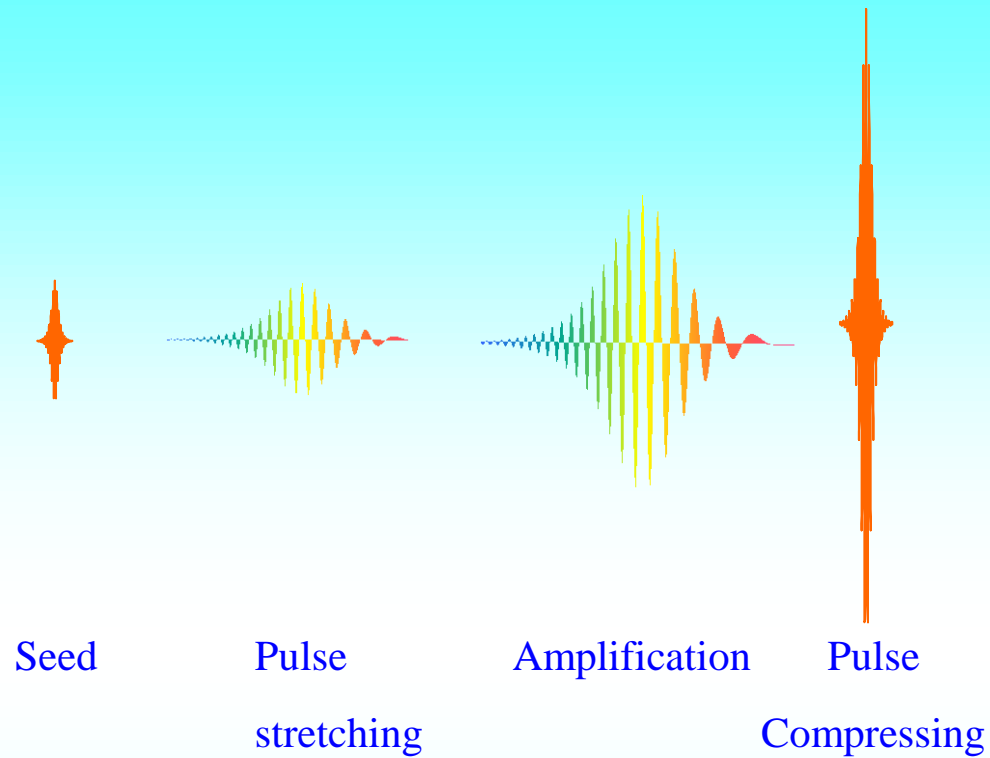

Then the stretched pulse, whose intensity is sufficiently low compared with the intensity limit of gigawatts per square centimeter, is safely introduced to the gain medium and amplified by a factor  $10^6$  or more. Finally, the amplified laser pulse is recompressed back to the original pulse width through the reversal process of stretching, achieving orders of magnitude higher peak power than laser systems could generate before the invention of CPA.

# How to get a fs laser pulse with various frequency?

## Optical parametric oscillation

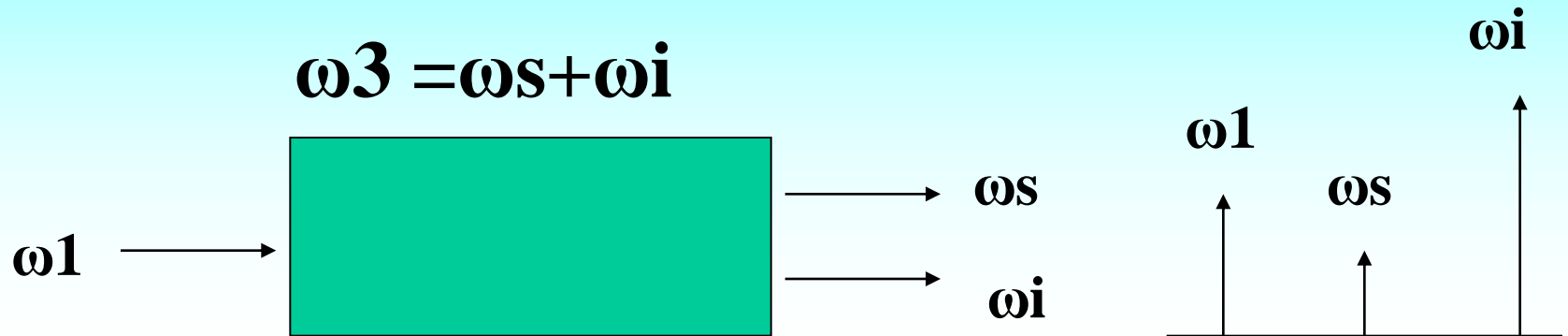

is a parametric oscillation which oscillates at optical frequencies. It converts an input laser wave (called "pump") into two output waves of lower frequency ( $\omega_s, \omega_i$ ) by means of nonlinear optical interaction. The sum of the output waves frequencies is equal to the input wave frequency:  $\omega_s + \omega_i = \omega_p$ . For historic reasons, the two output waves are called "signal" and "idler".

**$\beta$ -BBO ( $\beta$  -  $\text{BaB}_2\text{O}_4$ )**

**High  $\chi^{(2)}$ , mechanical strength, high breakdown threshold**



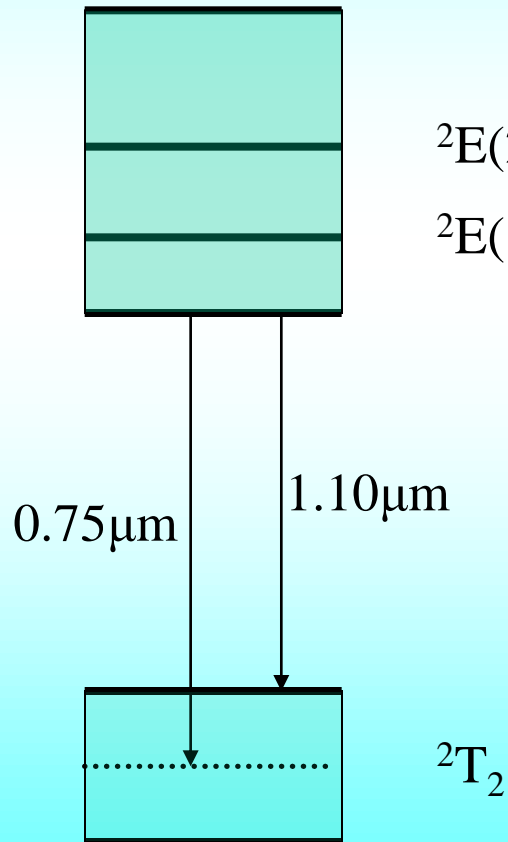
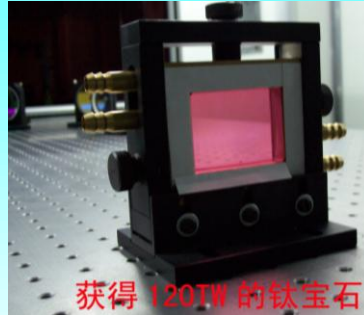

- 1 ) Large stimulated emission cross-section
- 2 ) High hardness , thermal conductivity
- 3 ) Available pumping source
- 4 ) 700nm-1 $\mu\text{m}$  tunable
- 5 ) easy to be mode-locked

# Three features of femtosecond laser:

1) ultrashort pulse

2) ultrahigh light intensity ( $>2 \times 10^{16} \text{W/cm}^2$ )

3) ultrabroad bandwidth (coherent) ( $\Delta \nu = 1 / \Delta \tau$ )

# Characteristic time of ultrafast processes

Rotation relaxation of molecules

Lifetime of excited electronic states

Coulomb explosion of molecules

Photodissociation of molecules

Electron-phonon relaxation

Molecular vibration period

Dissociation lifetime of clusters

Vibration period of phonons

Electron-electron collision

Thermal  
relaxation

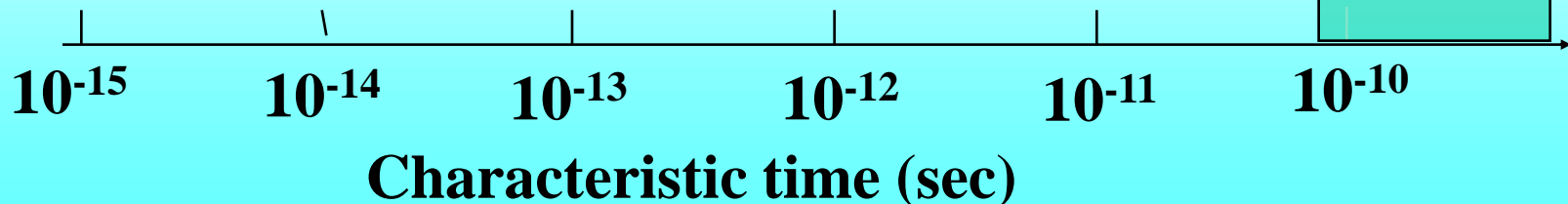

# Laser-matter interactions

ns-laser  
processes

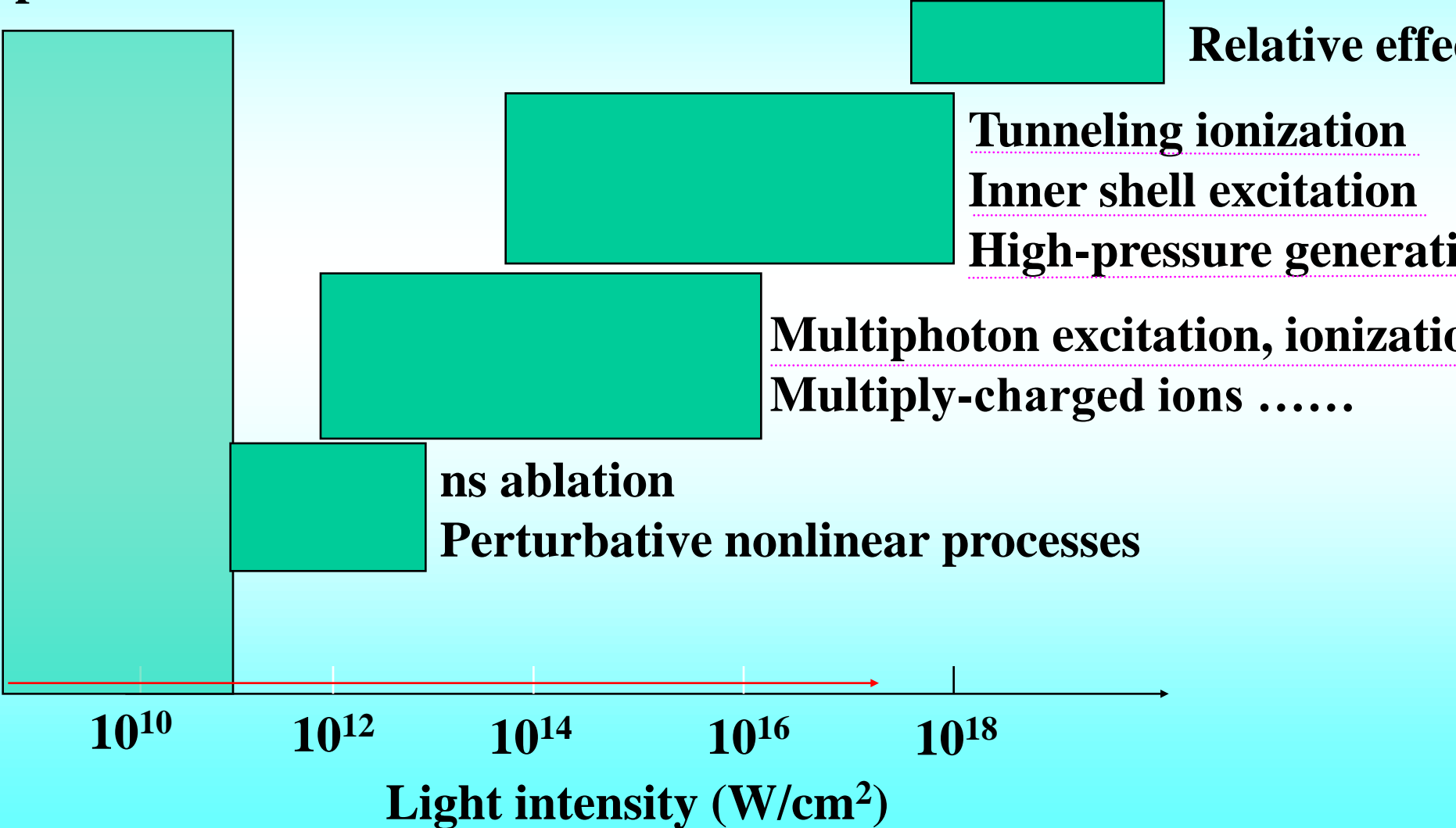

# Applications of femtosecond laser

## 1 Ultrashort pulse

Nonlinear optics

TeraBit optical communication ( soliton transmission etc. )

Ultrafast spectroscopy ( Pump-Probe spectroscopy )

Multiphoton Microscope

Nano-Bio

Nano-surgery

## 2 High coherent pulse-train

Multi-photon excitation spectroscopy

Precise measurement of light frequency

## 3 High electric field

Laser-induced plasma and X-ray

Monochromatic electron beam

Generation of oriented X-ray and  $\gamma$ -ray

CIF

Laser-triggered lightning

## 4 High coherent broadband spectrum

Terahertz time-resolved spectroscopy



Pictures taken during a bullet shooting a steel plate using ultrafast camera  
Time resolution:  $5\mu\text{s}$

# Studying the dynamic process of chemical reaction

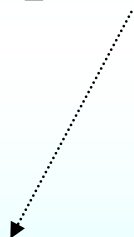

**Intermediate state : life time about 500fs**

# Femtosecond pump-probe technique

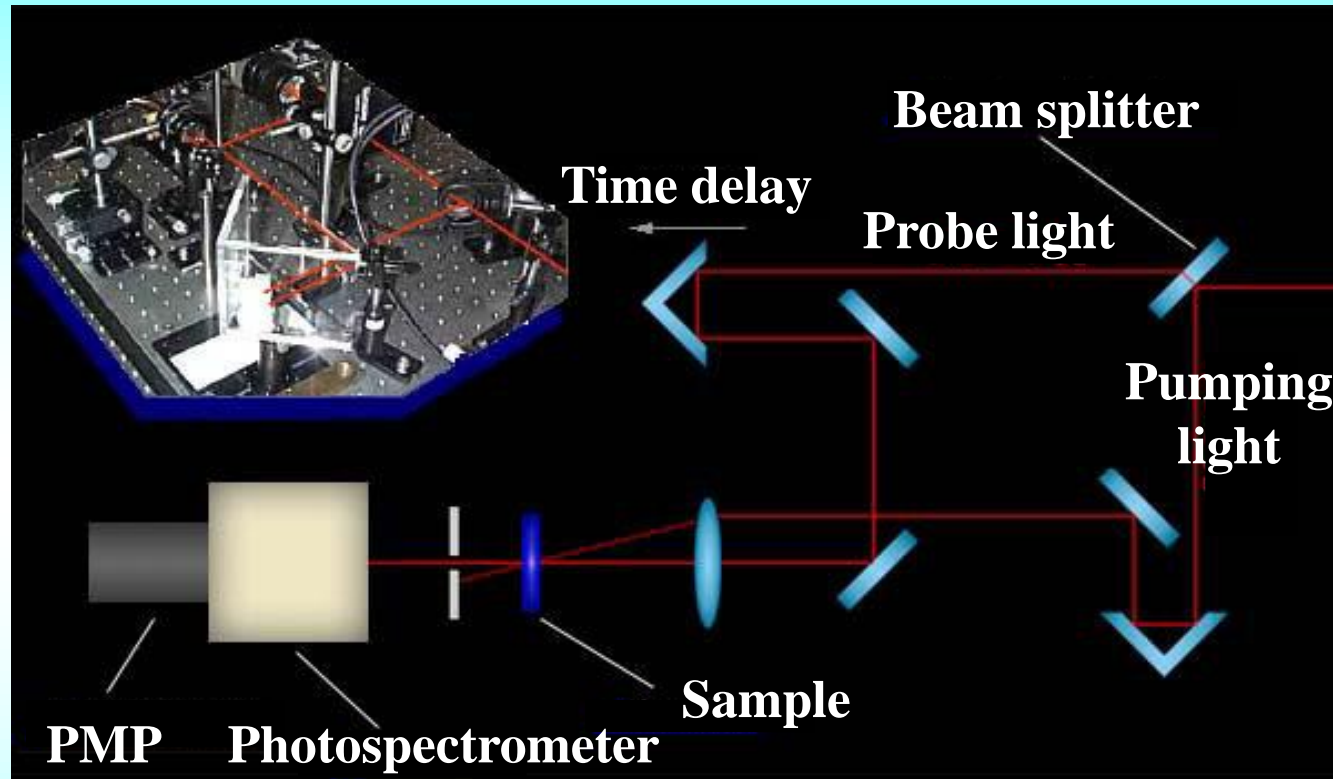

Use two pulses (strong pump and weak probe). A pump pulse excites the sample and triggers the process under investigation. A second delayed pulse, the probe, monitors an optical property. By varying the time delay between the pump and probe pulses, it is possible to assemble measurements as a function of time.



# Ultrashort pulse: Femto-spectroscopy

## Femtochemistry



**Prof. Zewail  
(Caltech)**

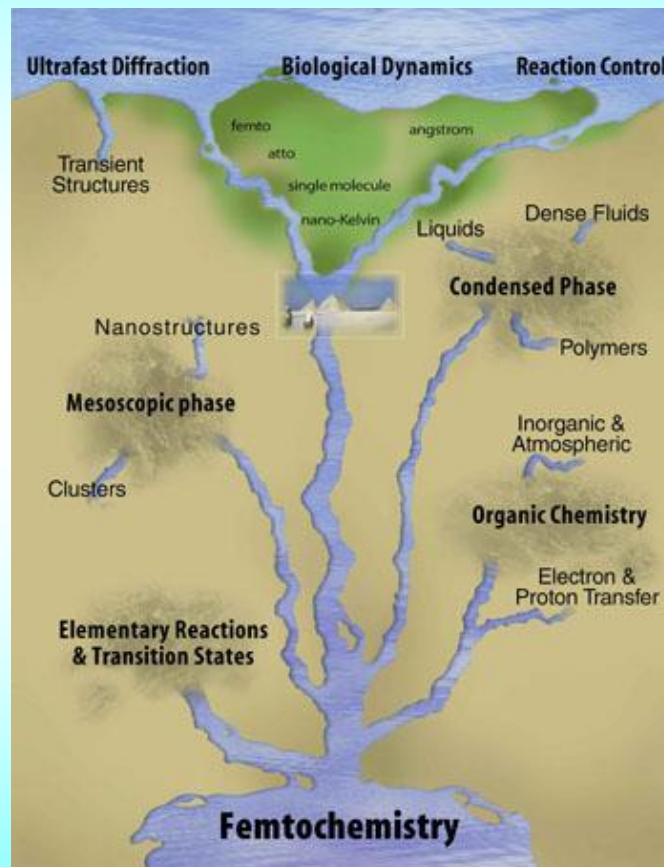

for showing that it is possible with **rapid laser technique** to see how atoms in a molecule move during a chemical reaction.

# Ultrashort pulse train: Femto-spectroscopy

## Precise measurement of light frequency

(Optical comb)

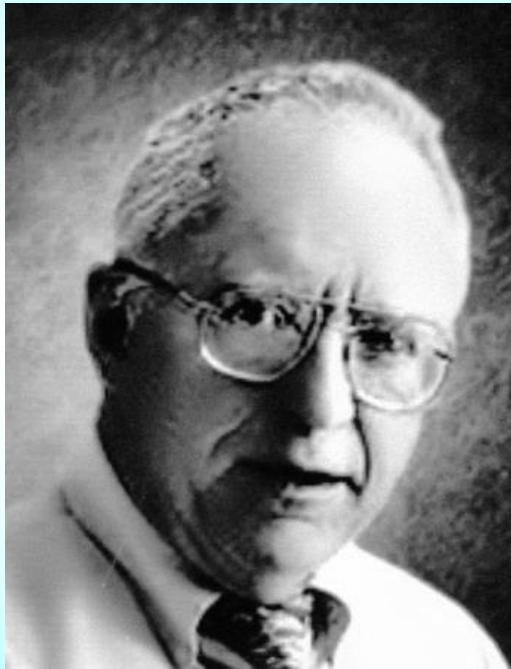

J. L. Hall



T. W. Haensch

for their contributions to the development of laser-based precision spectroscopy, including the optical frequency comb technique: a very precise tool for measuring different colors—or frequencies—of light, **only made possible by recent advances in ultrafast femtosecond lasers.**

# Basic idea of our research

## External field

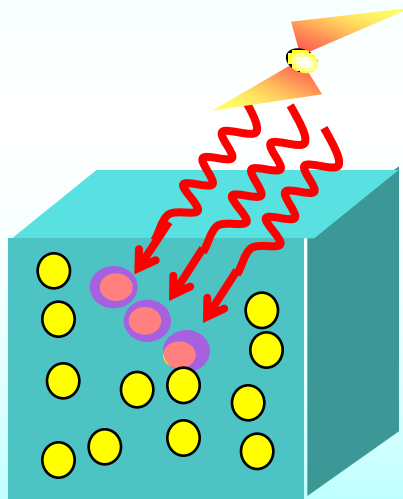

**Glass**

● induced electronic structure

● e.g. rare-earth

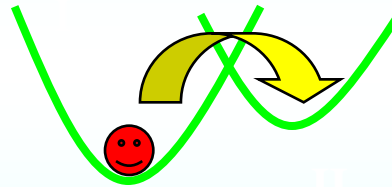

- Electric field
- Magnetic field
- Laser
- Radiation

•

•

•

# **Features of femtosecond laser :**

- 1) Elimination of the thermal effect due to extremely short energy deposition time**
- 2) Participation of various nonlinear processes enabled by high localization of laser photons in both time and spatial domains**

# 3-dimensional micro-modification

UV laser

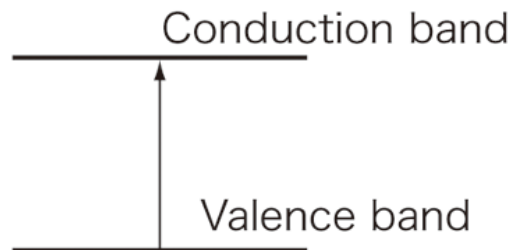
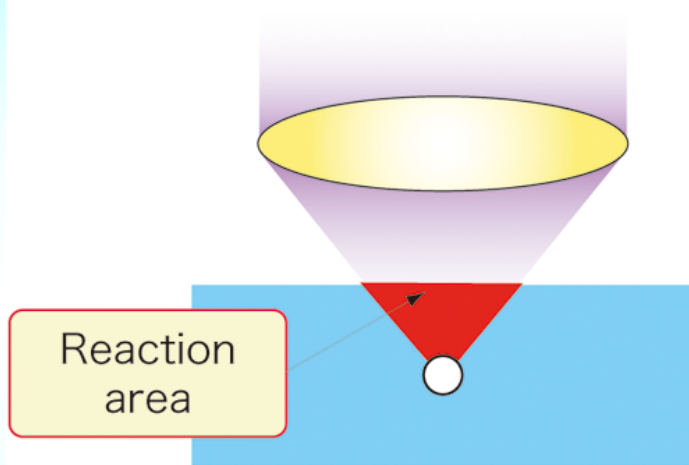

Single-photon absorption

fs laser

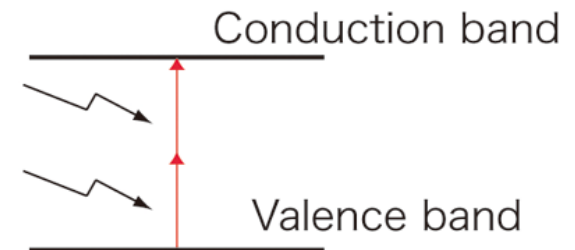
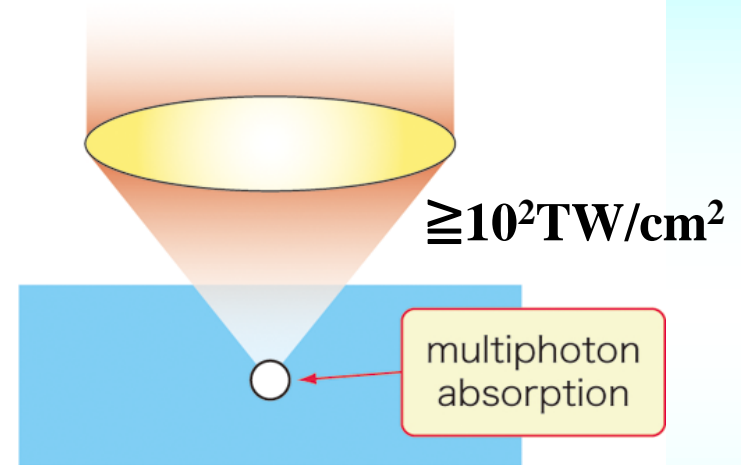

Multi-photon absorption

$$\chi = \sigma (I/h\nu)^n$$



# Applications of induced microstructures

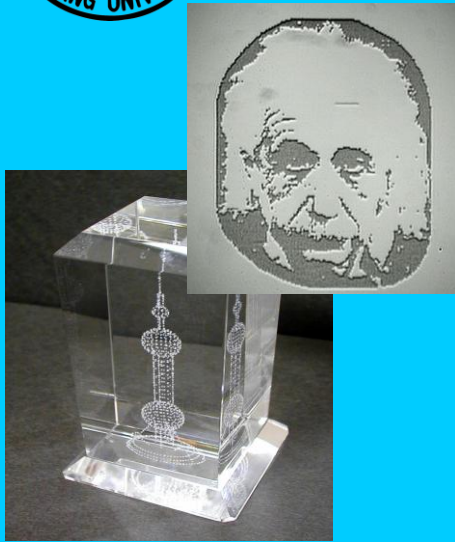

3D image



3D memory

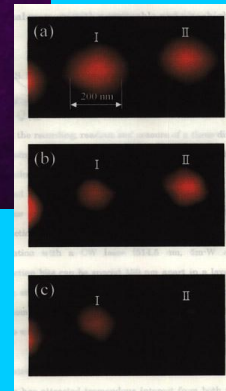

Intensity (a.u.)

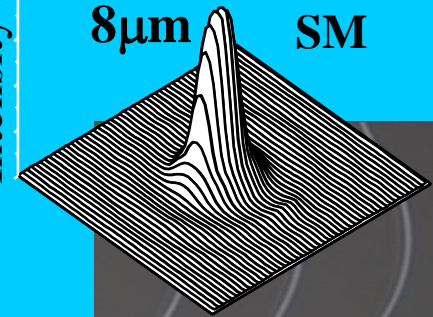

8 $\mu$ m SM

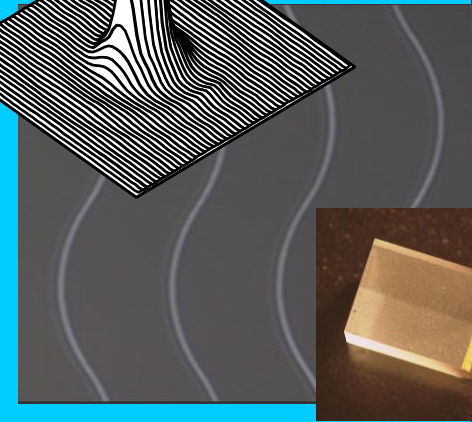

Optical Waveguide

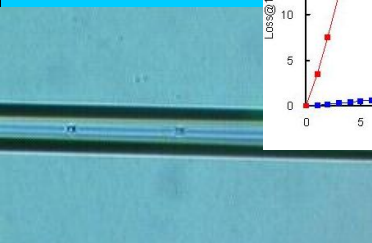
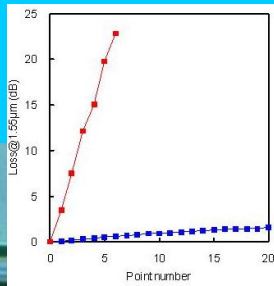

Fiber grating



Micro-grating

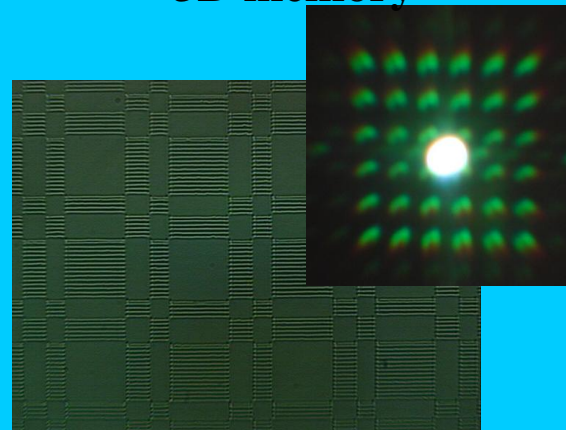

Micro-lens

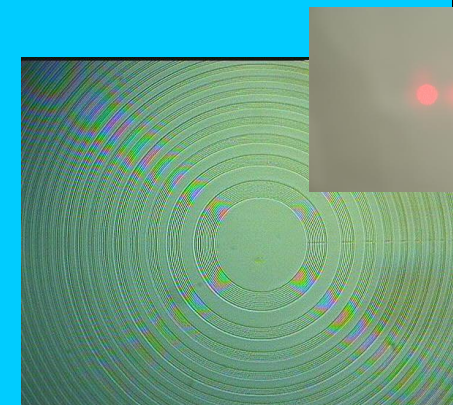

**No intrinsic absorption**  $n h \omega \geq E_g$

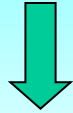

**Multiphoton absorption rate**  $P(I)_{MPI} = \sigma_n I^n$

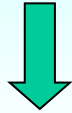

**Avalanche ionization (via impact ionization)**



**Exponential growth of the free electrons.**



**A highly absorptive and dense plasma, induce various phenomena due to nonlinear processes**

# **Some of the related important research**

- 1) H. Misawa, Japanese Patent 1994.**
- 2) K. M. Davis et al., Opt. Lett., 21(1996)1729.**
- 3) E. N. Glezer et al., Opt. Lett., 21(1996)2023.**
- 4) K. Miura et al., Appl. Phys. Lett., 71(1997)3329.**
- 5) S. Juodkazis et al., Phys. Rev. Lett., 96(2006)166101.**
- 6) P. G. Kazansky et al., Phys. Rev. Lett., 82, 2199 (1999).**
- 7) D. Homoelle et al., Opt. Lett., 24(1999)1311.**
- 8) K. Kawamura et al., Appl. Phys. Lett., 79(2001)1228.**
- 9) A. Marcinkevicius et al., Appl. Phys. Lett., 26(2001)277.**
- 10) H. Sun et al., Opt. Lett., 20(2001)325.**





# Optical setup

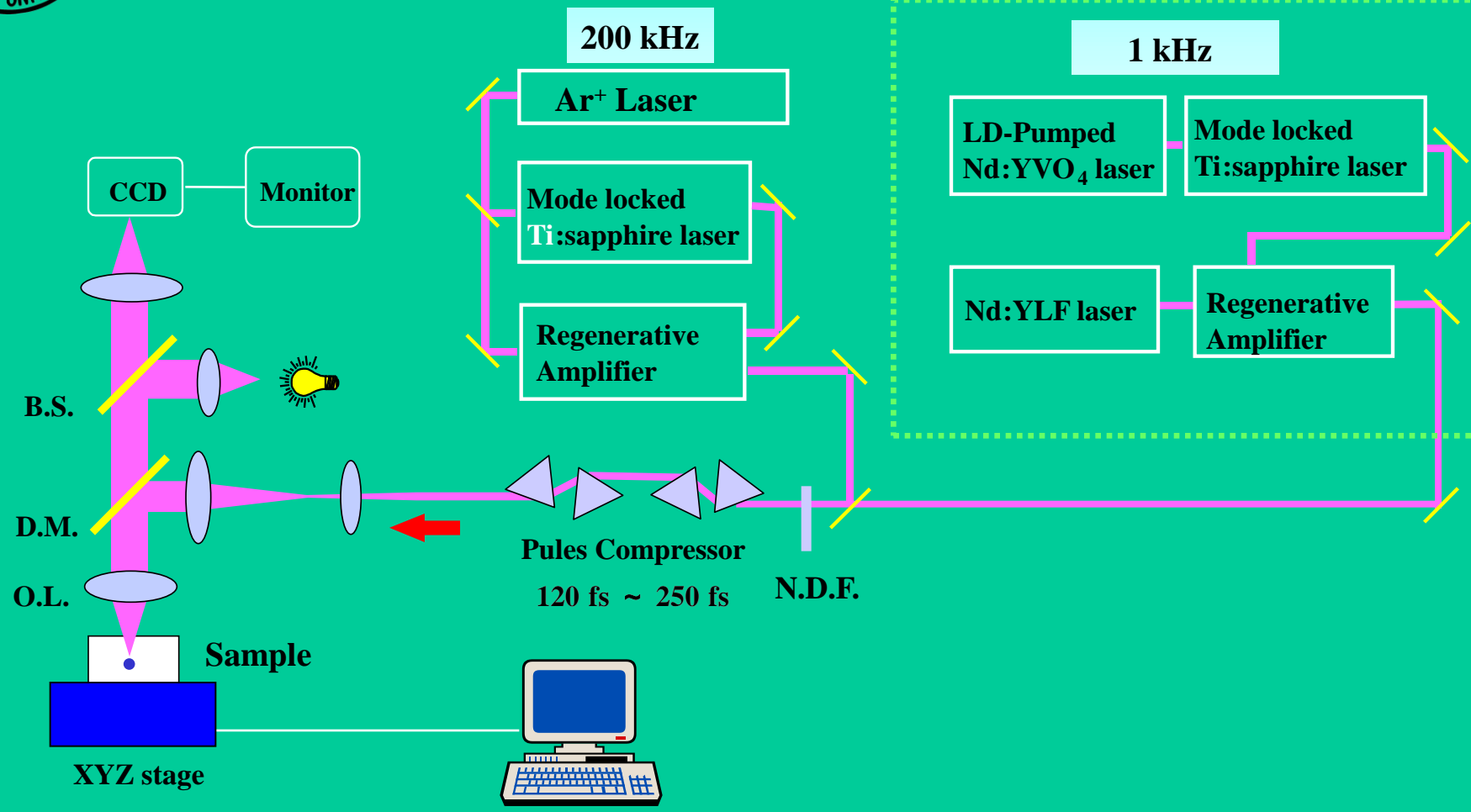

# Laser systems for direct 3D writing

Pulse energy  
 $5\mu\text{ J}$

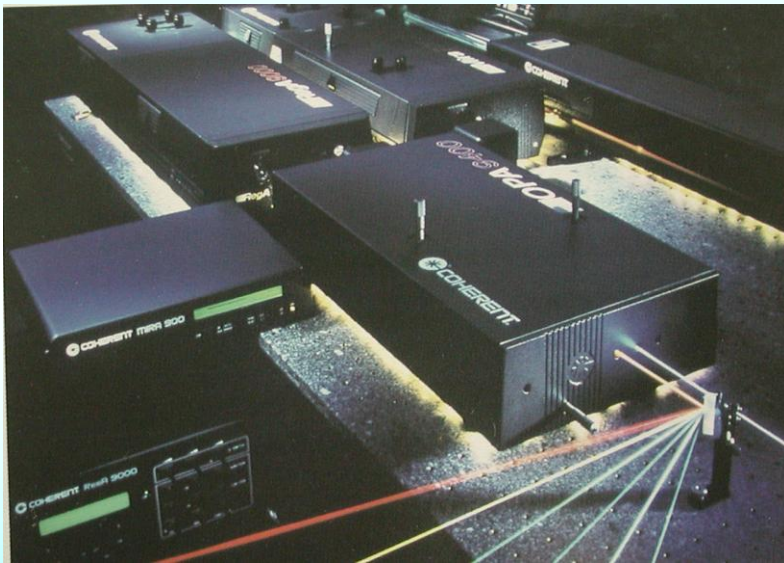

Pulse energy  
 $1\text{ m J}$



**200KHz Ti:Sapphire femtosecond  
laser system  
(Coherent Co. Ltd)**

**1KHz Ti:Sapphire femtosecond  
laser system  
(Spectra-Physics Co. Ltd)**



# During and after fs laser irradiation

**Emission**

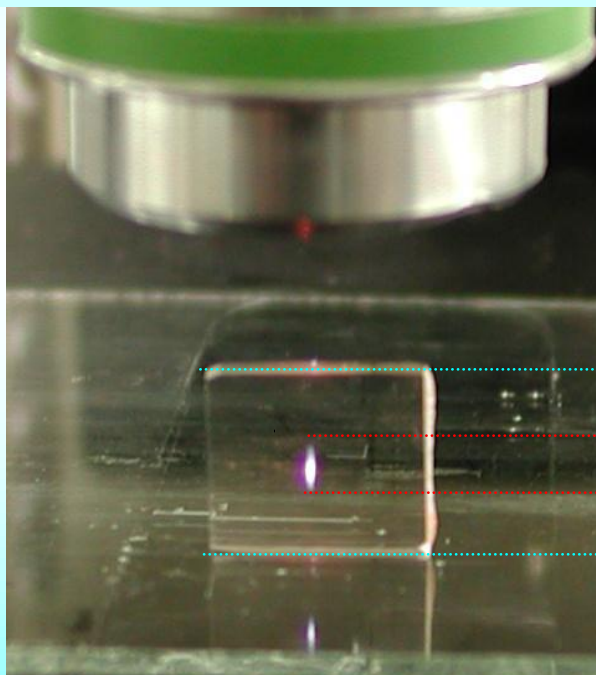

**Coloration**

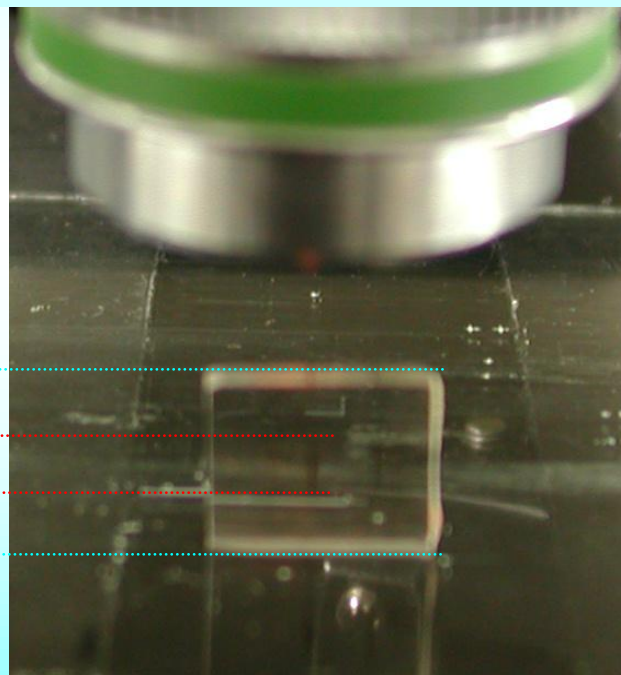

# Femtosecond laser induced microstructures

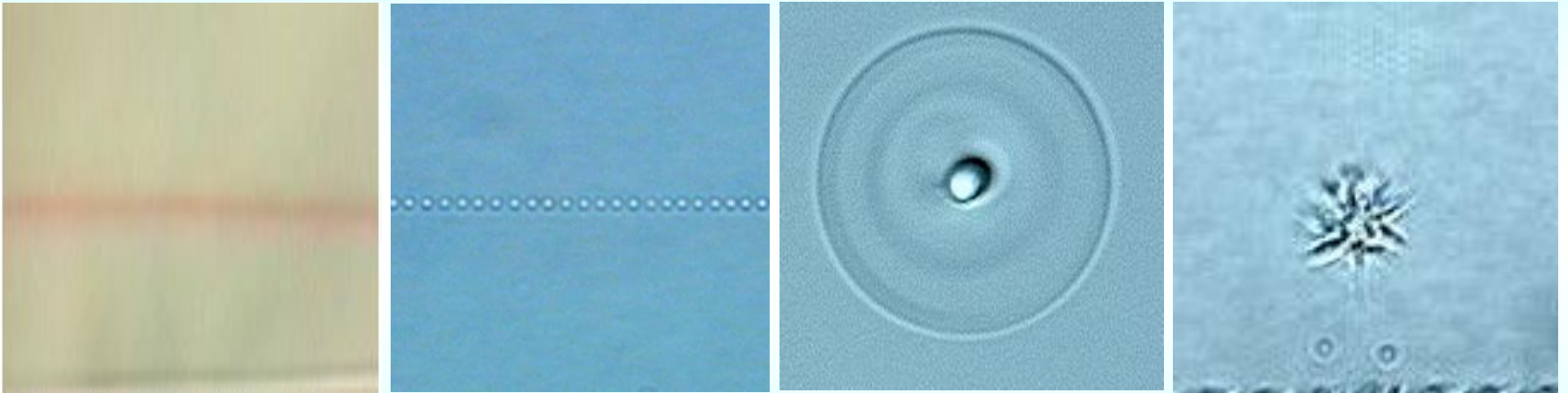

**Various structures induced by  
800 nm, 120fs laser-pulses**

# Fs laser induced valence state change of transition metal ions

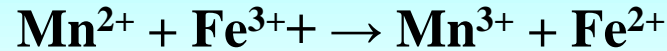

1KHz  
10x(NA=0.3)  
3mW  
120fs

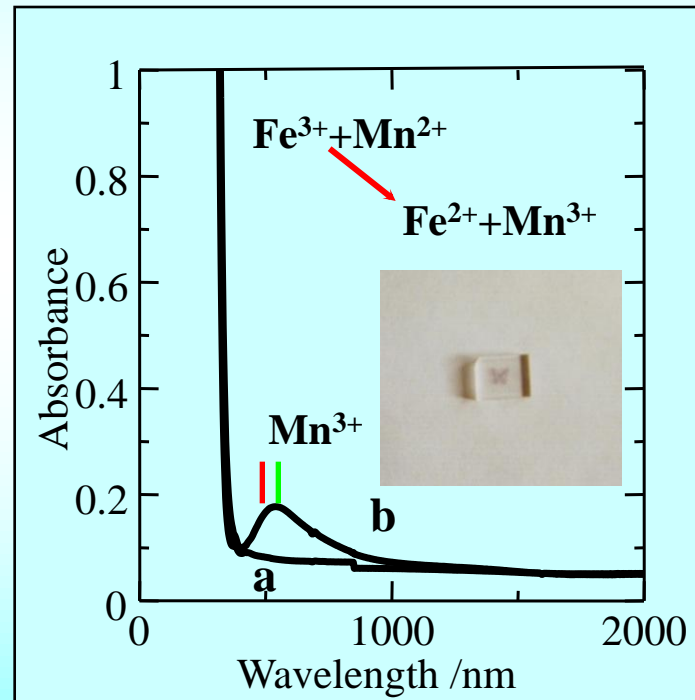

20Na<sub>2</sub>O-10CaO-  
70SiO<sub>2</sub>-0.1Fe<sub>2</sub>O<sub>3</sub>-  
0.1MnO (mol%)

Absorption spectra

a: before irradiation b: after irradiation (iron and manganese)

*Appl. Phys. Lett.*, 79(2001)3567.

# Fs laser induced valence state change of noble metal ions



$\text{Na}_2\text{O}-\text{Al}_2\text{O}_3-\text{P}_2\text{O}_5-0.1\text{Ag}_2\text{O}$  (mol%)

*Opt. Express*, 12(2004)4035.

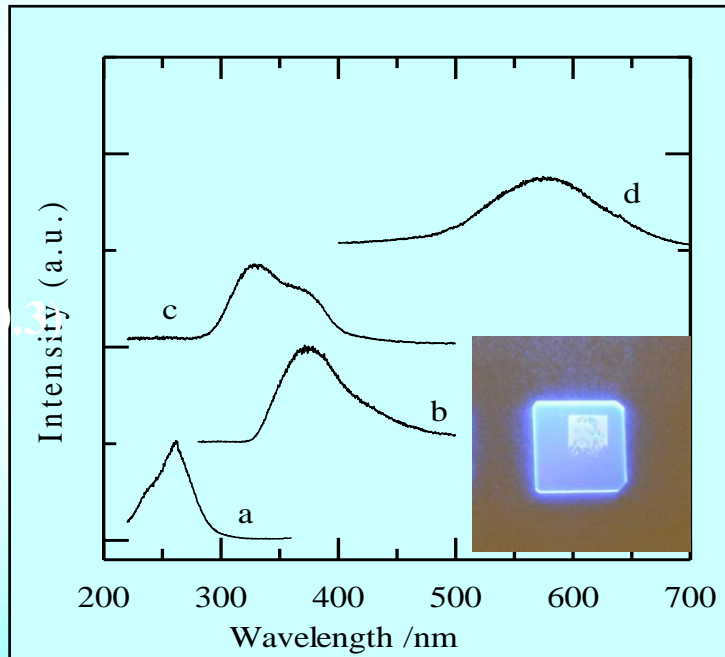

**Emission and excitation spectra**  
a, b: before irradiation  
c, d: after irradiation

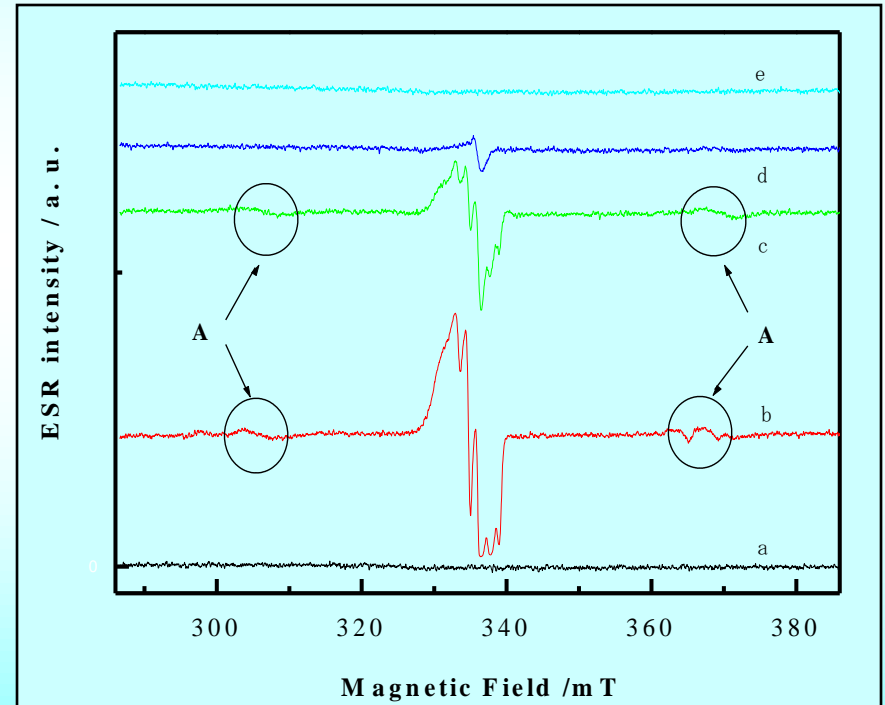

**ESR spectra**  
a: before irradiation b: after irradiation

# Fs laser induced valence change of heavy metal ions



*J. Mat. Chem.* 19(2009)4603.

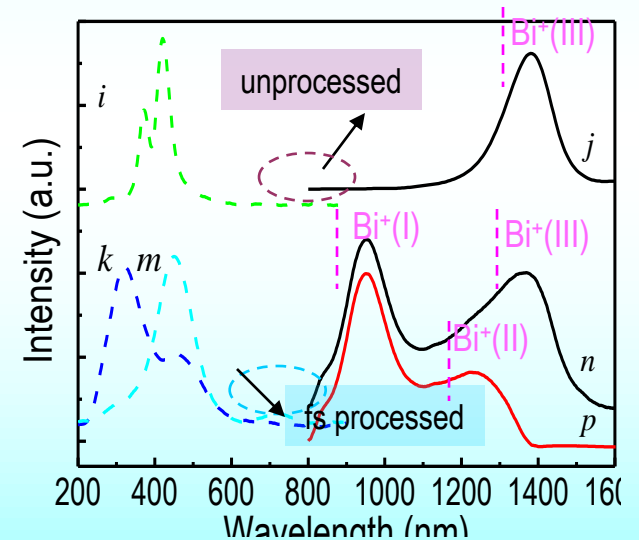
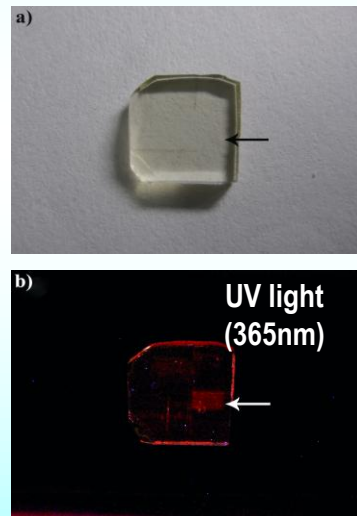
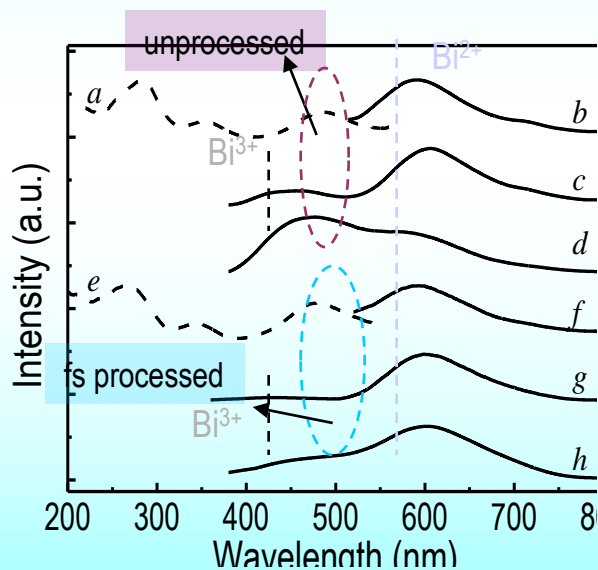

**Visible and infrared luminescence changes after fs laser irradiation**

# Fs laser induced valence change of rare earth ions

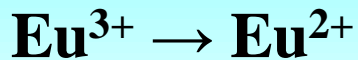

*Appl. Phys. Lett.*, 74(1999)10.

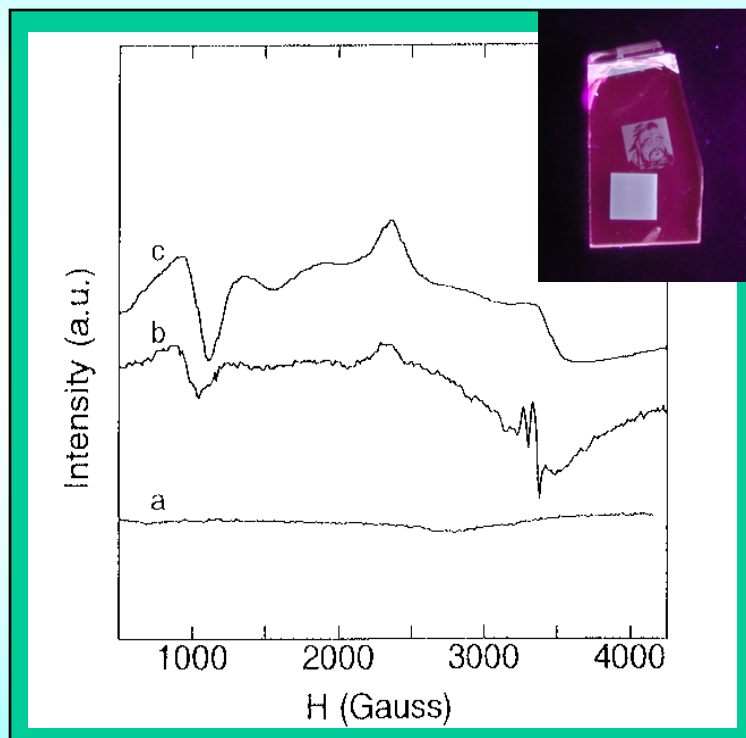
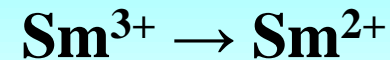

ESR spectra of  $\text{Eu}^{3+}$ -doped ZBLAN glass before (a) and after (b) the femtosecond laser irradiation and the spectrum (c) of a  $\text{Eu}^{2+}$ -doped  $\text{AlF}_3$ -based glass sample

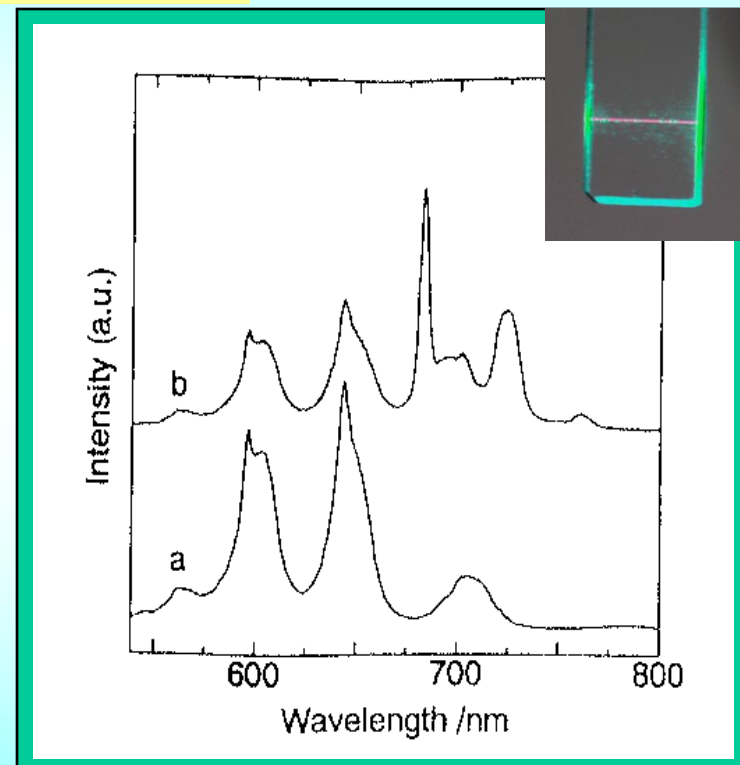

Photoluminescence spectra of a  $\text{Sm}^{3+}$ -doped borate glass before and after the femtosecond laser irradiation



# 3D rewriteable memory using valence state change of **Sm ion**

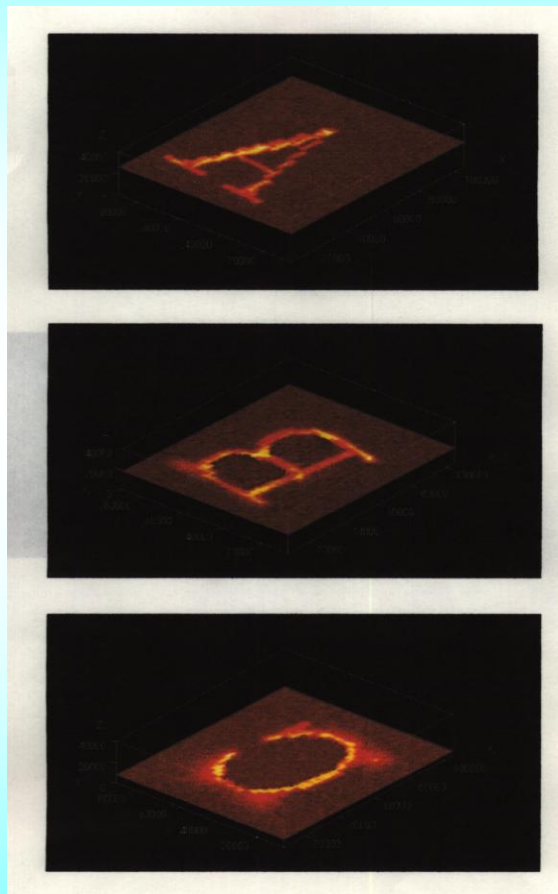

Three layers spaced  $2\mu\text{m}$

*Appl. Phys. Lett.*, 80(2002)2263.

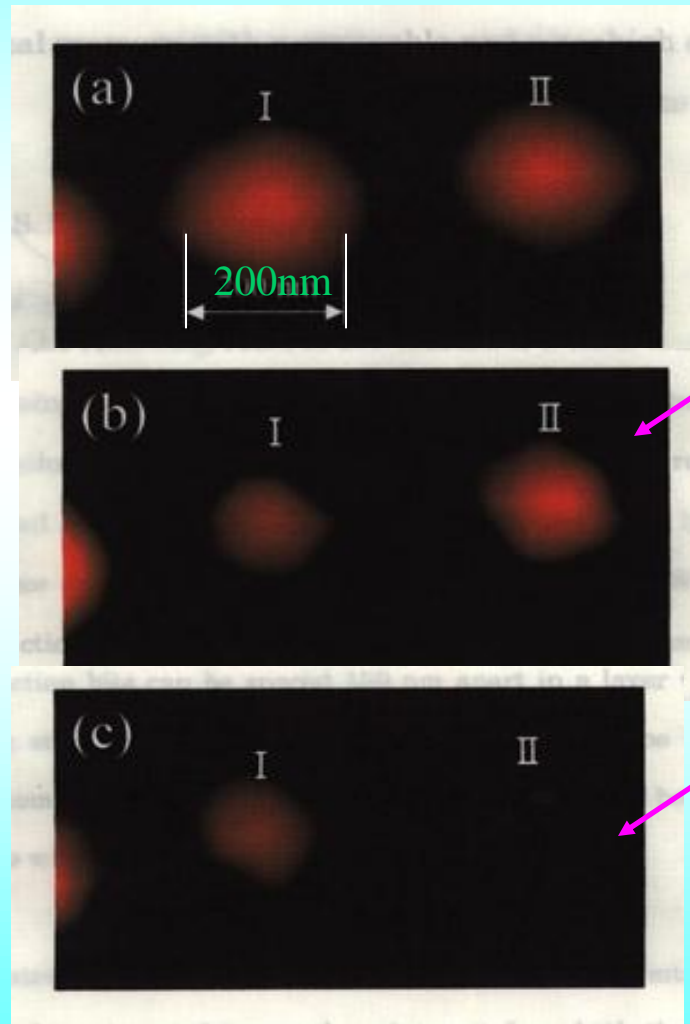

4f-4f  $\text{Sm}^{2+}$   
692nm

fs  
488nm  $\text{Ar}^+$

fs + 514nm  $\text{Ar}^+$   
488nm  $\text{Ar}^+$

## materials update

search this site:  gosearch nature:  start page

welcome  
news  
nanozone  
research highlights  
past highlights  
features  
research archive  
material of the month  
careers  
conference calendar  
authors  
advertising  
about us  
contact us

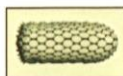

resources

Nature

Nature Materials

Nature

## In brief: Writing memories in light

**Three-dimensional memories offer the potential for incredibly high data storage densities, but creating a rewritable 3D memory medium has proved tricky. Now a group of Japanese researchers have developed an all-optical rewritable memory material with a capacity of 10 Tbit cm<sup>-3</sup>.**

11 April 2002

Jonathan Dawid

Three-dimensional optical memories, which store data on multiple planes in a transparent medium, offer incredibly high storage capacities – as much as several terabits in a block the size of a sugar cube. (1 Tbit = 10<sup>12</sup> bit, equivalent to 200 CD-ROMs.) But although several suitable materials have been demonstrated that are suitable for read-only purposes, the ability to selectively erase and rewrite information has proved much harder to achieve. Now, writing in *Applied Physics Letters*, Miura, Qiu, Fujiwara, Sakaguchi and Hirao demonstrate a high-capacity 3D memory that can be written, read, erased and rewritten using all-optical methods.

The material in question is glass doped with ions of samarium, a rare-earth metal. These can be switched between two stable valence states, Sm<sup>3+</sup> and Sm<sup>2+</sup>, by photoreduction and photo-oxidation respectively,

## Related article

New  
Merit  
of gl  
14 ↑

In brief: Writing memories in light

Biotechnology

Nature Science  
UpdateNature Physics  
Portal

Naturejobs

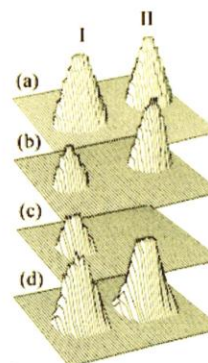

Distributions of photoluminescence intensity, showing selective erasure and rewriting of two neighbouring bits spaced 200 nm apart. **a**, Both bits in the photoreduced (Sm<sup>2+</sup>) state. **b** and **c**, after 'erasing' bits I and II respectively by photo-oxidation with a continuous-wave laser. **d**, After 'rewriting' both bits using photoreduction by femtosecond laser irradiation.

and are distinguished by their different photoluminescence spectra. This combination of properties allowed the authors to develop an all-optical memory device in which bits are represented by the ionic valence state. Femtosecond laser pulses are used to 'write' bits by photoreducing Sm<sup>3+</sup> to Sm<sup>2+</sup>, whereas to 'erase' the bit, the ions are photo-oxidized back to the 3+ state with a continuous-wave laser. Read-out is achieved using a weaker laser to excite a photoluminescence peak of the Sm<sup>2+</sup> species that is completely absent in Sm<sup>3+</sup>, giving excellent signal-to-noise characteristics and allowing bits to be packed very close together. Crucially, the physical independence of neighbouring bits makes it possible to store information in three dimensions, which the authors demonstrate by recording three separate images on planes spaced 2 μm apart. Because each bit can be made with an in-plane diameter of only 150 nm, this corresponds to an information storage density of 10 Tbit cm<sup>-3</sup>.

### Three-dimensional optical memory with rewritable and ultrahigh density using the valence-state change of samarium ions

We report the recording, readout, and erasure of a three-dimensional optical memory using the valence-state change of samarium ions to represent a bit. A photoreduction bit of 200 nm diam can be recorded with a femtosecond laser and readout clearly by detecting the fluorescence as a signal

# Femtosecond laser induced microstructures

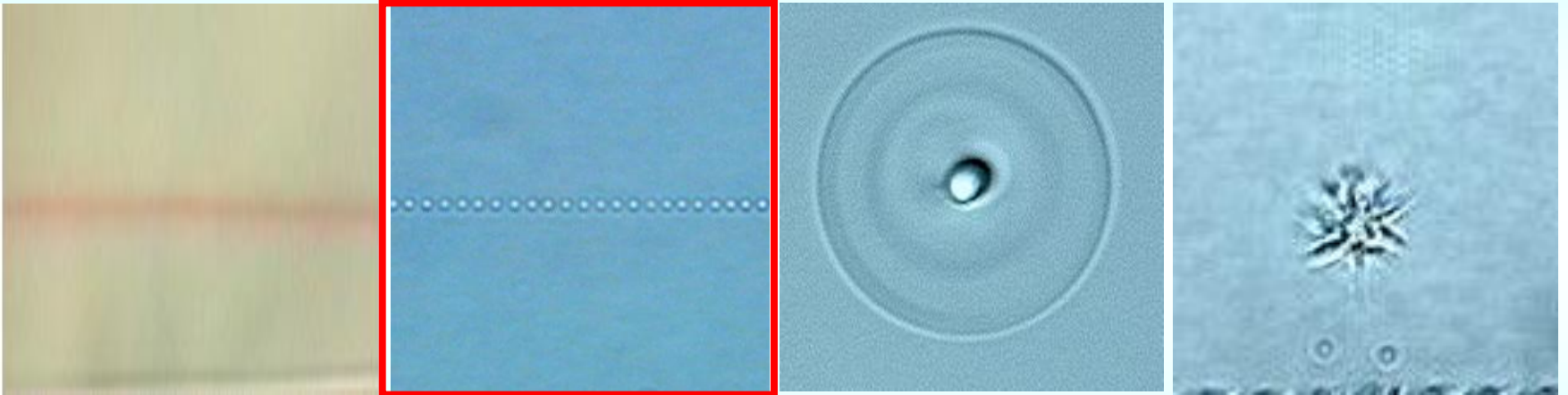

**Various structures induced by  
800 nm, 120fs laser-pulses**

# Femtosecond laser direct writing

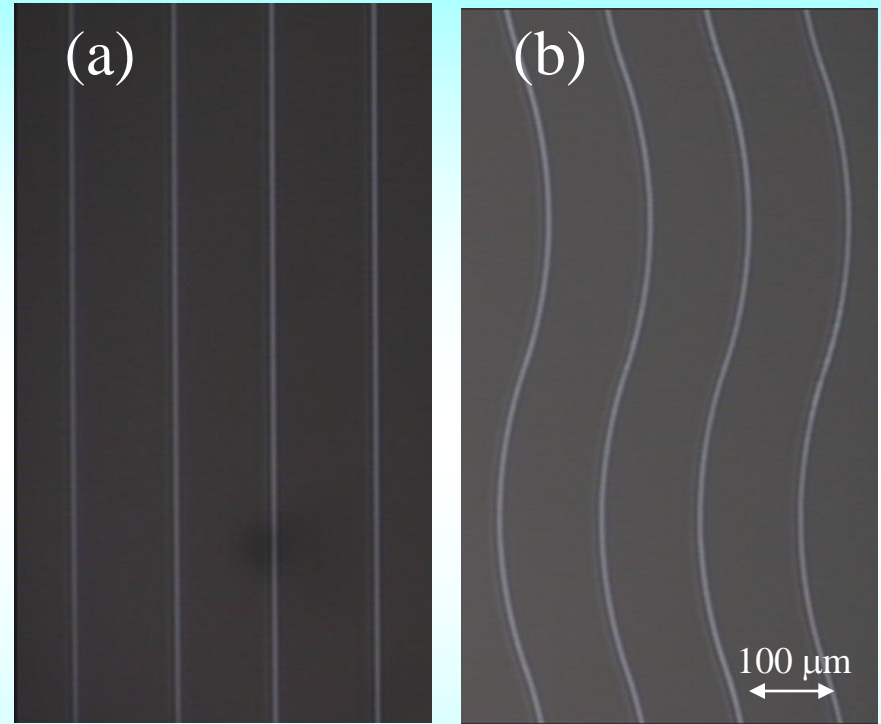
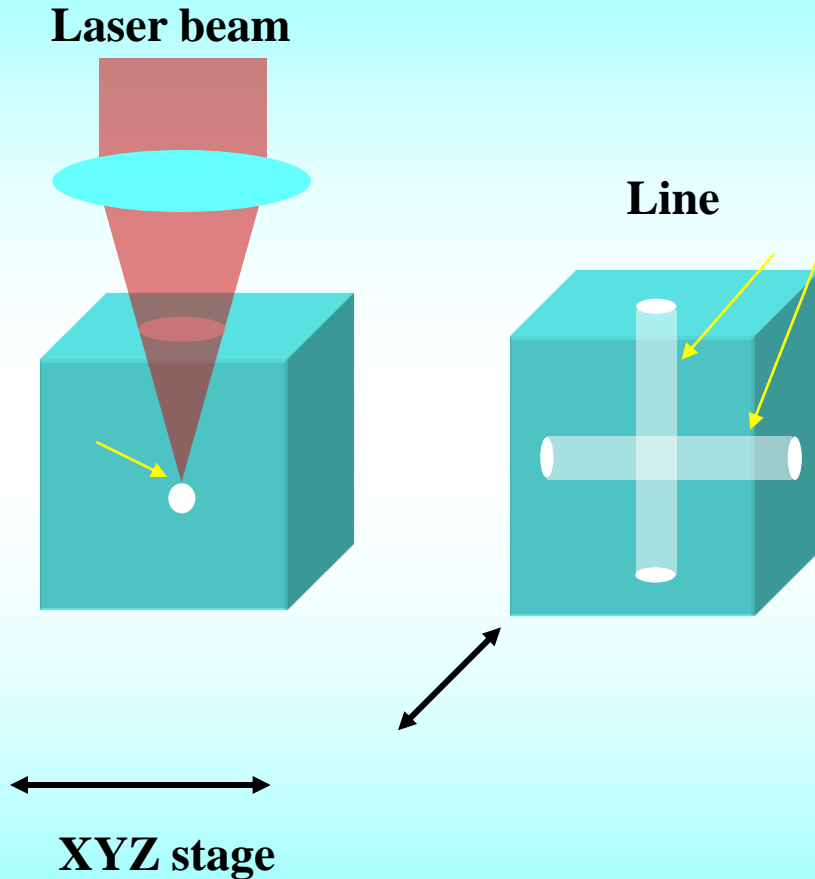
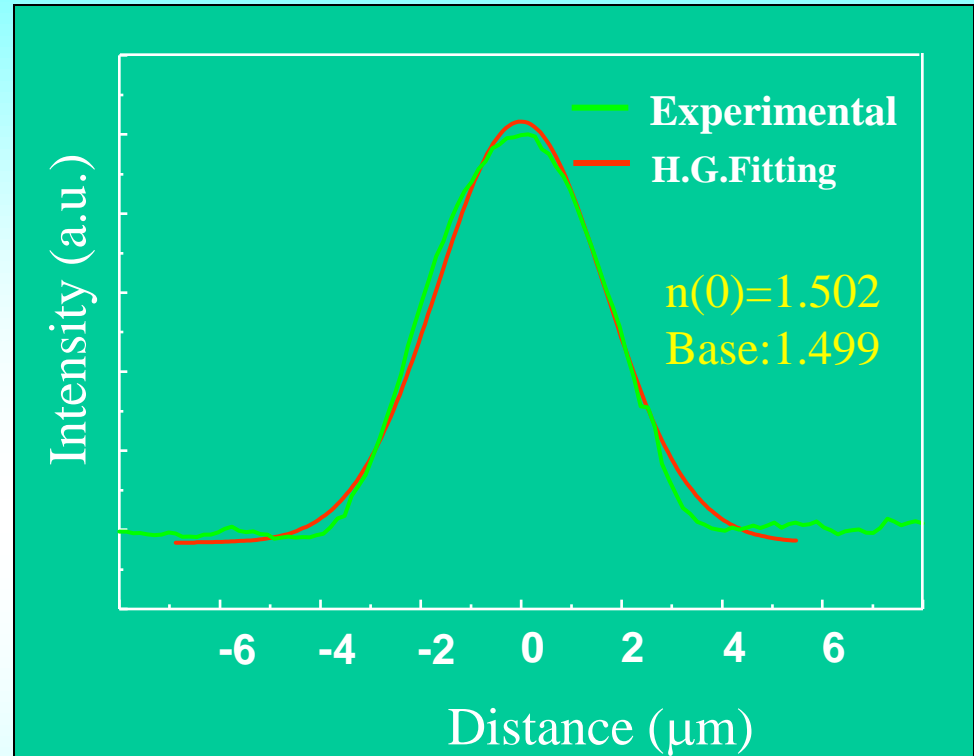
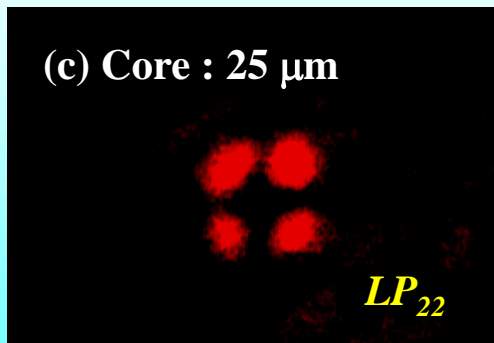
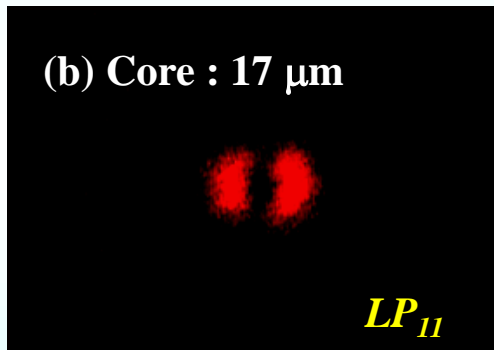
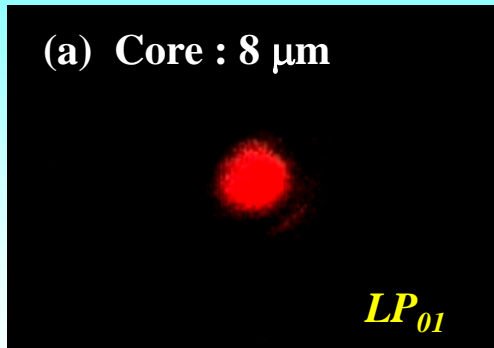

Photo-written lines in a glass formed using 800-nm 200-kHz mode-locked pulses. The lines were written by translating the sample (a) parallel or (b) perpendicular to the axis of the laser beam at a rate of 20  $\mu\text{m/s}$  and focusing the laser pulses through a 10X or 50X microscope objective, respectively.

# Mode-field patterns



Result of Hermite-Gaussian fitting for the intensity distributions of the near field. The sample was the same as that observed in (a). The calculated result is almost in agreement with the experimental data, indicating that this waveguide is a graded-index type with a quadratic refractive-index distribution.

# Internal loss of waveguides

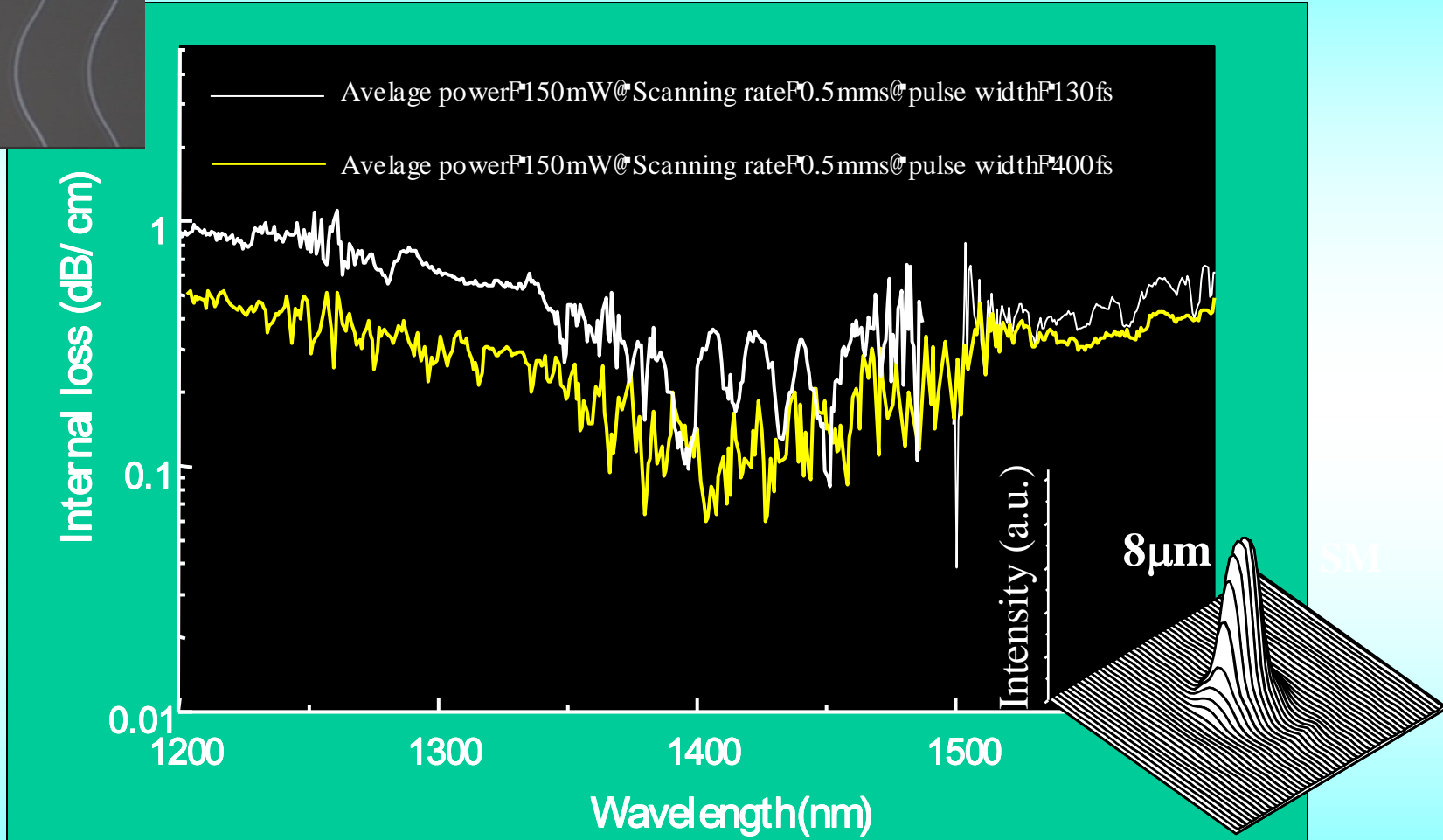
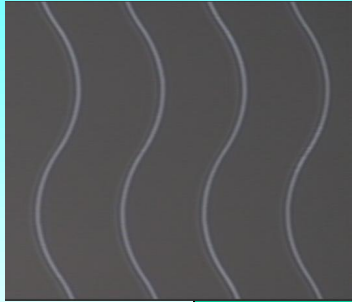

*Appl. Phys. Lett.*,  
71(1997)3329.

Internal loss of waveguides drawn by translating the silica glass perpendicular to the axis of the laser beam

# Direct writing of grating and lens

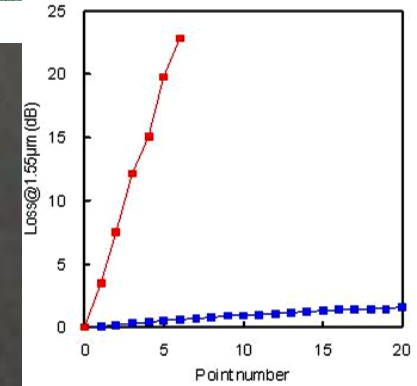
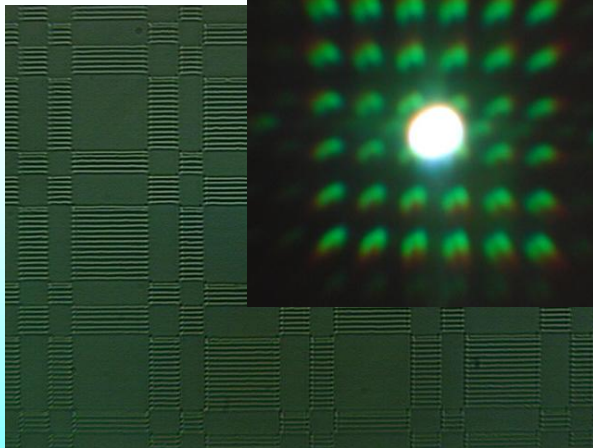
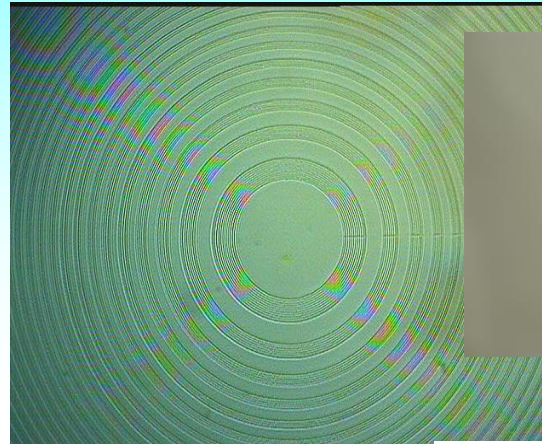
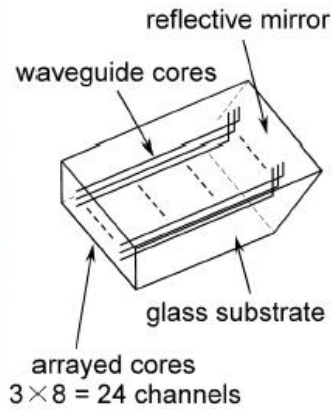
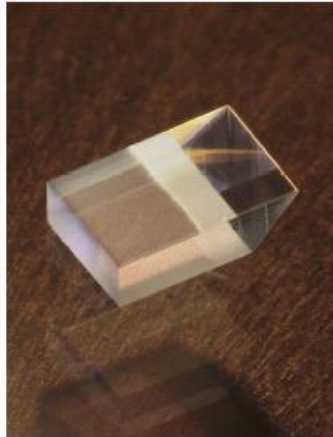

*Appl. Phys. Lett.*, 71(1997)3329.

*Opt. Lett.*, 29(2004)2728.

# Precipitation of functional crystal

Fs laser with high repetition rate=Local heat source

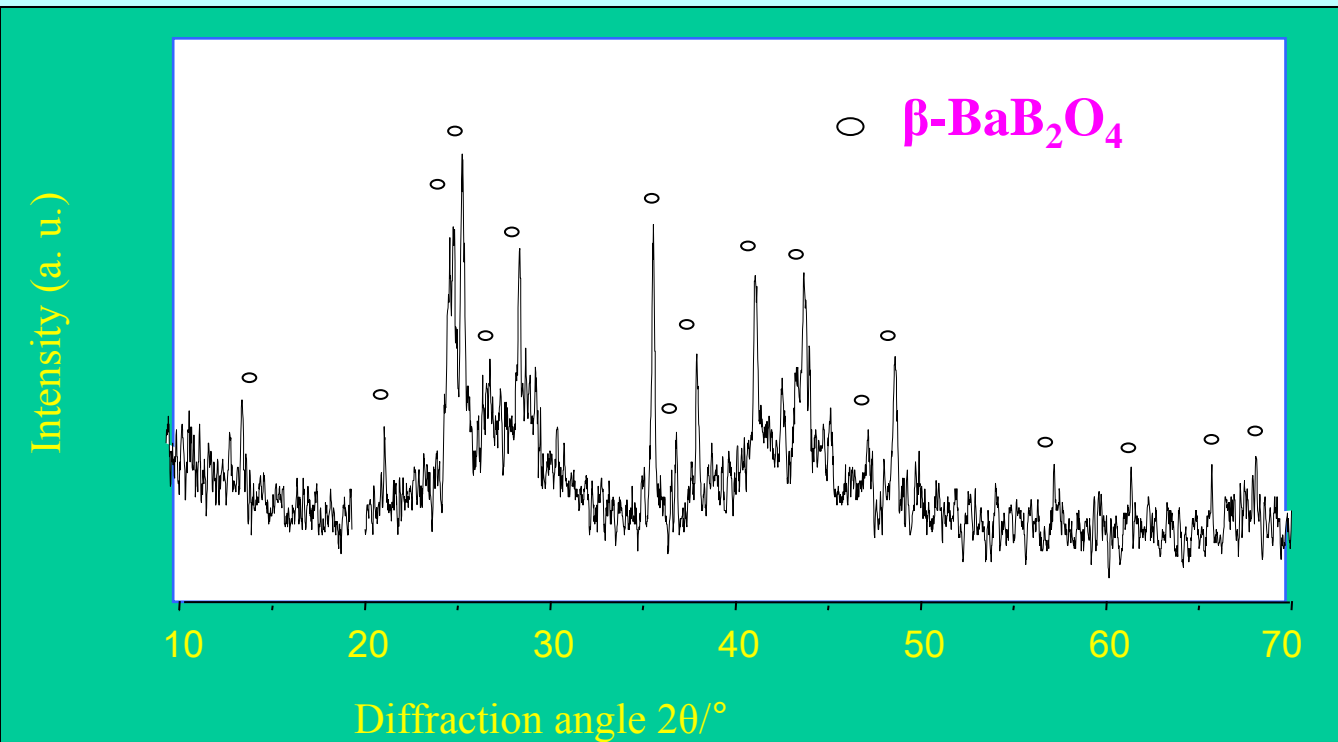

**XRD pattern**



**Photograph**

*Opt. Lett.*, 25(2000)408.



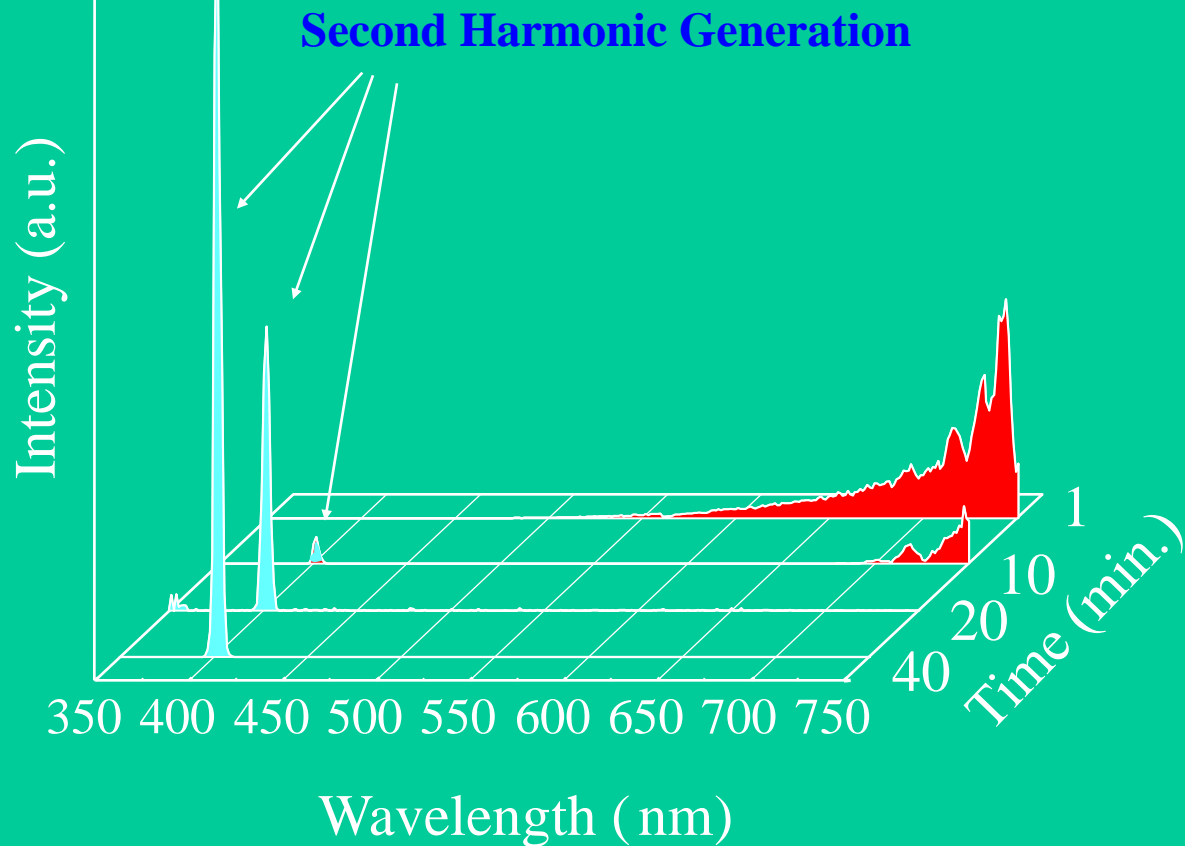

Variation of emission spectra obtained from moving the laser focal point that accompanies growth of frequency conversion crystals.

# Effect of $\text{Ag}^+$ on fs laser induced precipitation of crystals

*Opt. Lett.*, 34(2009)1666.

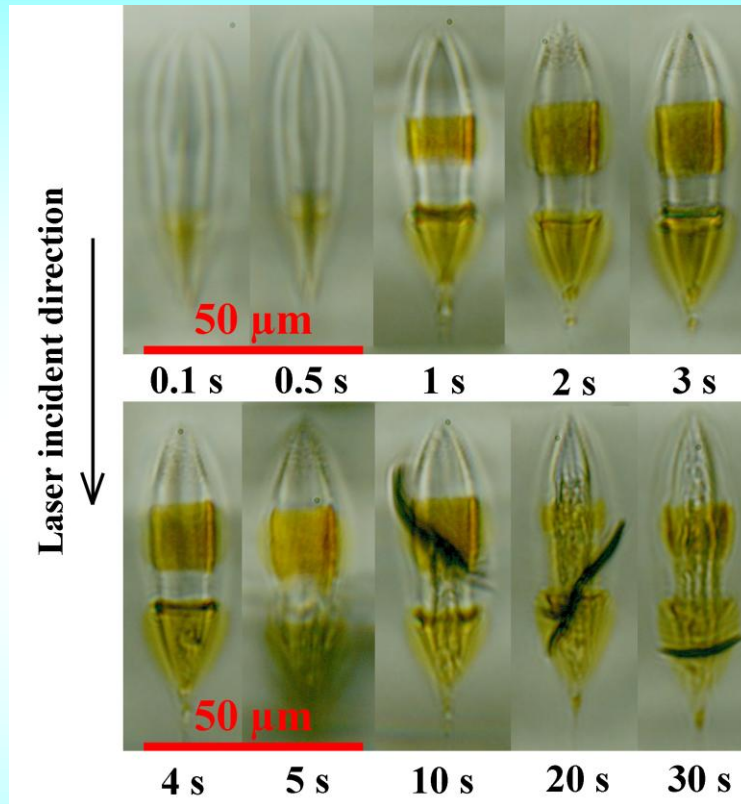

Micrographs of side-view of the focal regions illuminated by natural light after femtosecond laser irradiation (laser power: 900 mW, irradiation time: 0.1-30 s).

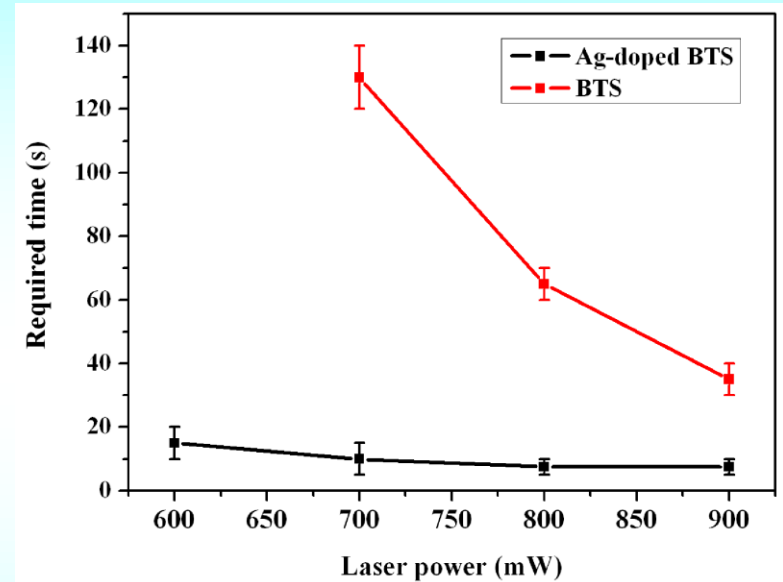

Dependence between the required time for crystallization and the laser power in  $\text{Ag}^+$ -doped BTS glass and pure BTS glass.

# 3D microdrilling of photosensitive glasses

(developed by Dr. Stookey)

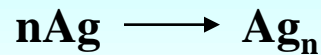
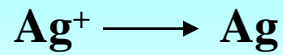

$$V_c \gg V_g$$

in diluted HF solution

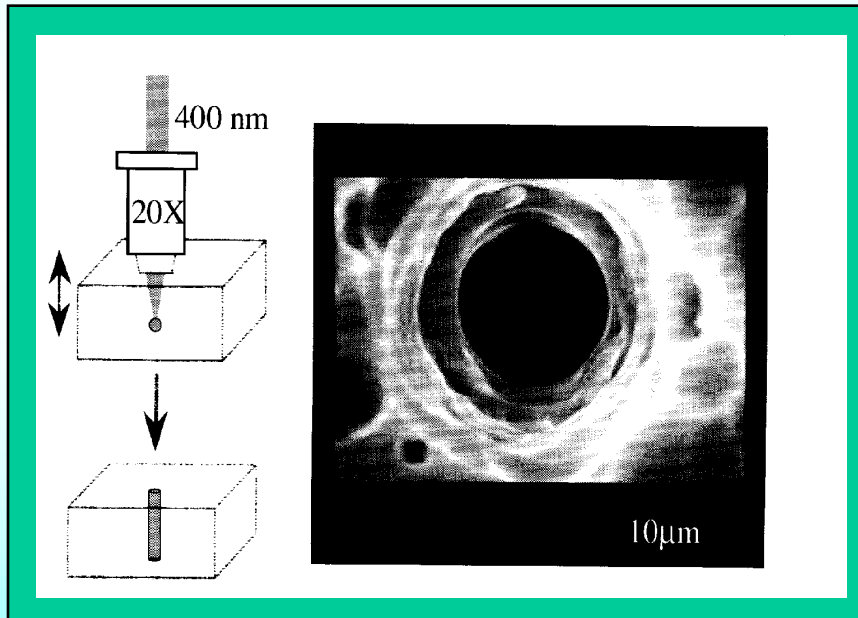

Straight hole

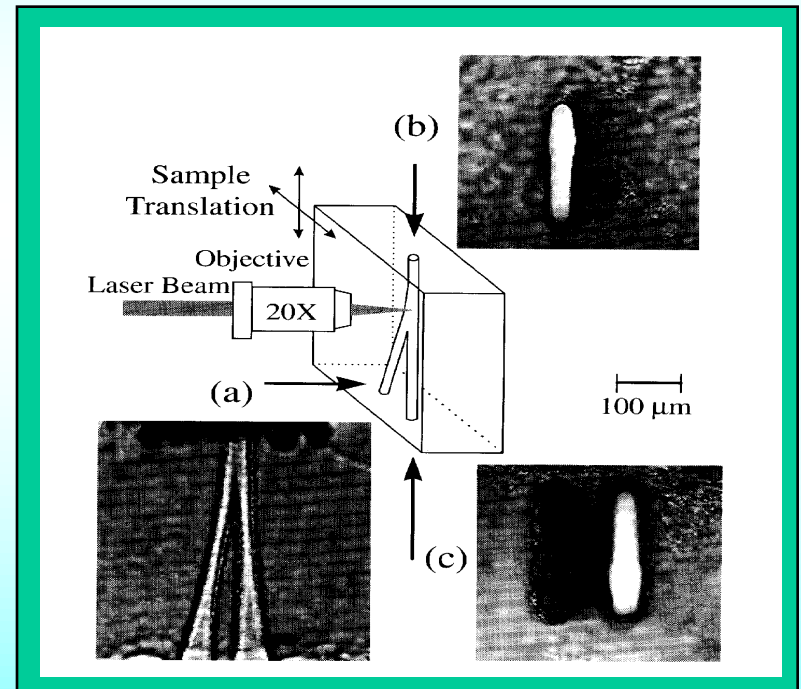

Y-branch holes

*Jpn. J. Appl. Phys.*, 38(1999)L1146.

# Space-selective precipitation of nanoparticles

*Angew. Chem. Int. Ed.*, 43(2004)2230.

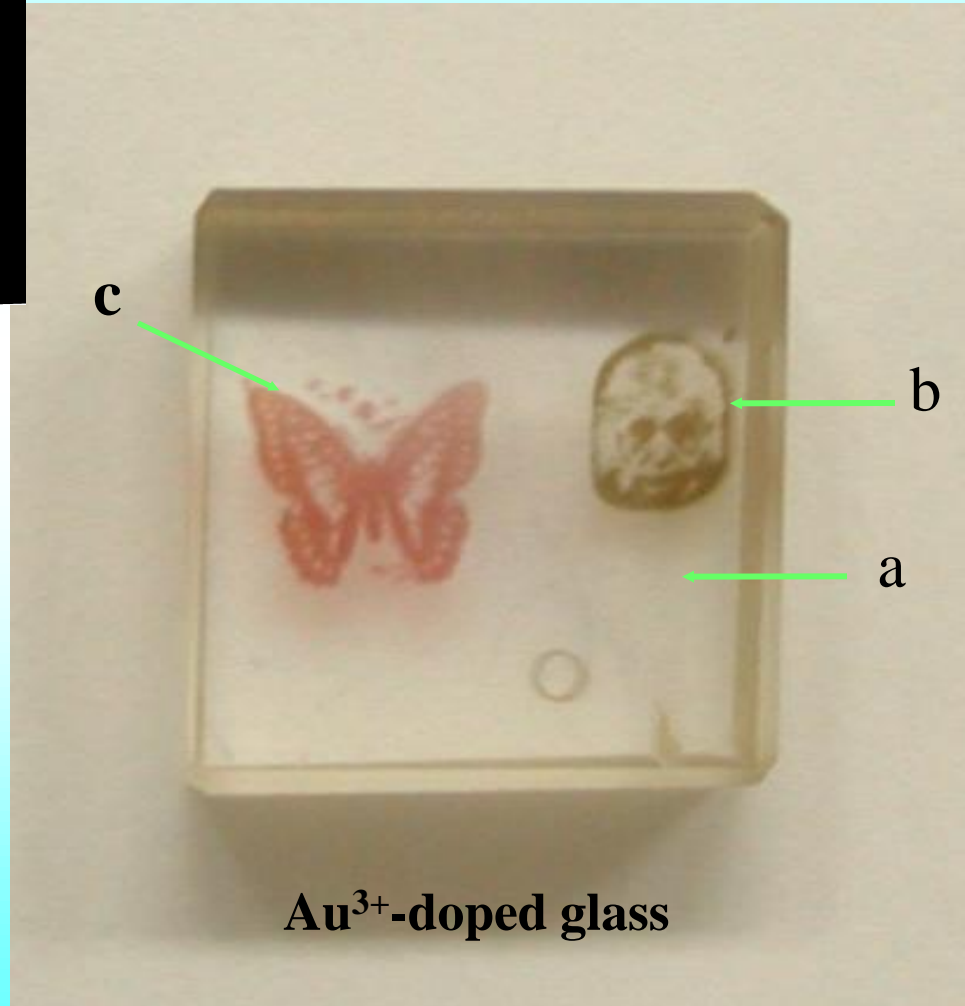
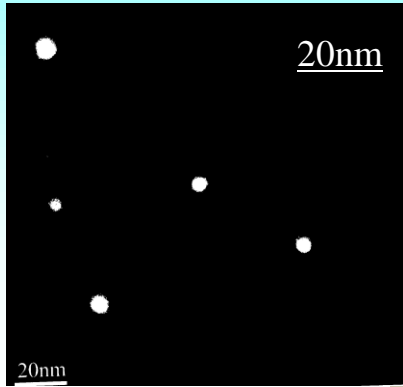

**a: before irradiation**

**b: after irradiation**

**c: after annealing at**

**550°C for 10min**

# Size control of precipitated Au nanoparticles

*Angew. Chem. Int. Ed.*, 43(2004)2230.

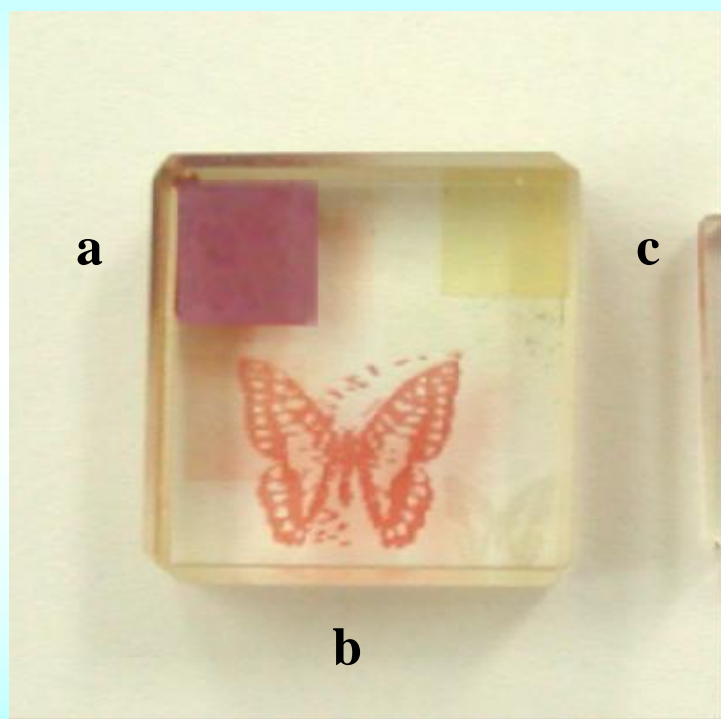

**a:**  $6.5 \times 10^{13} \text{ W/cm}^2$

**b:**  $2.3 \times 10^{14}$

**c:**  $5.0 \times 10^{16}$

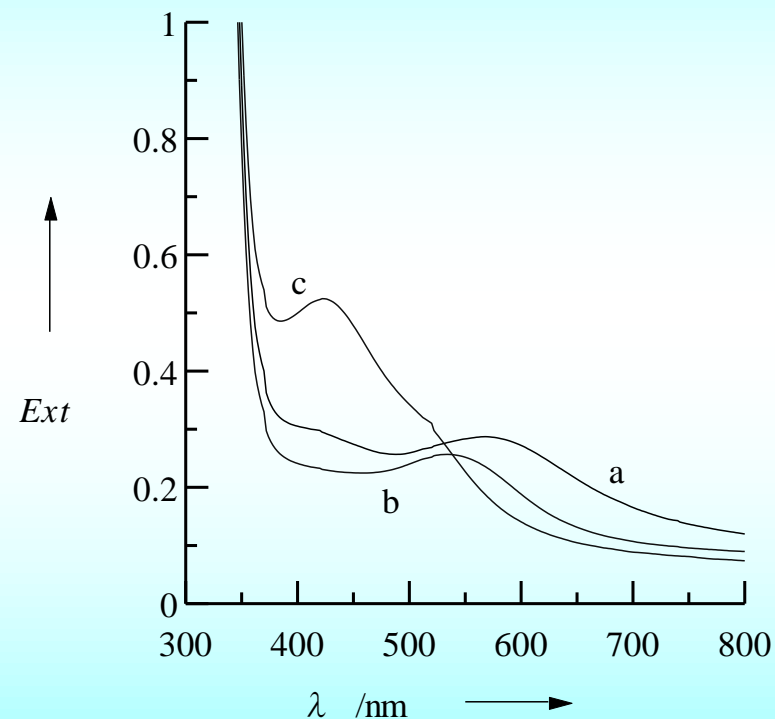

**Absorption spectra**

# Space-selective dissolution of Au nanoparticles

*Angew. Chem. Int. Ed.*, 43(2004)2230.

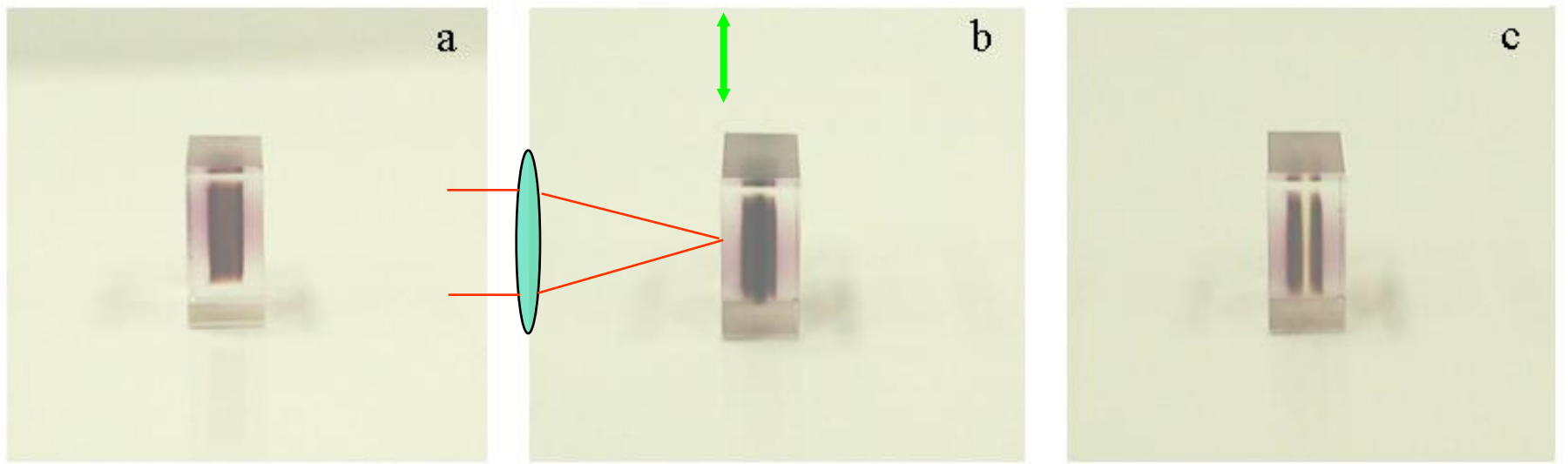

**a: before second laser irradiation**

**b: after second laser irradiation**

**c: after second laser irradiation and  
annealing at 300°C for 30min**

### Going dotty

Making a three-dimensional circuit is no easy task, however. At the moment, chip designers build them layer by layer, but this is a laborious process and it limits the designs that can be used. Now Jianrong Qiu, a physicist at the Shanghai Institute of Optics and Fine Mechanics, and colleagues from China and Japan have worked out a way to draw the desired circuit directly into a block of glass.



Three dimensions means faster chips and more memory.

Sofar the researchers have used the technique to create three-dimensional images in the glass, such as the butterfly shown here. The 5-millimetre-wide image is made from millions of tiny balls of gold, each about seven nanometres across, which is roughly 10,000 times thinner than a human hair. The researchers report their results in the latest edition of the chemistry journal *Angewandte Chemie*<sup>1</sup>.

© Angewandte Chemie

It is even possible to erase

Making a three-dimensional circuit is no easy task, however. At the moment, chip designers build them layer by layer, but this is a laborious process and it limits the designs that can be used. Now Jianrong Qiu, a physicist at the Shanghai Institute of Optics and Fine Mechanics, and colleagues from China and Japan have worked out a way to draw the desired circuit directly into a block of glass.

# Three-dimensional engrave in glass

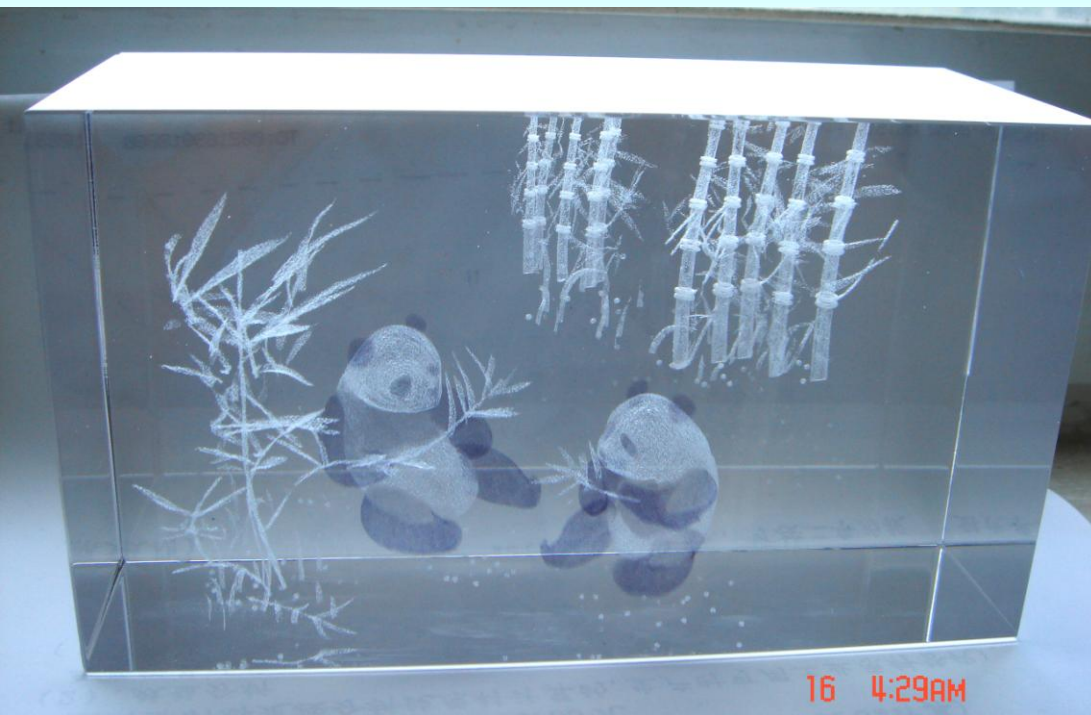



# Novel femtosecond laser-induced phenomena

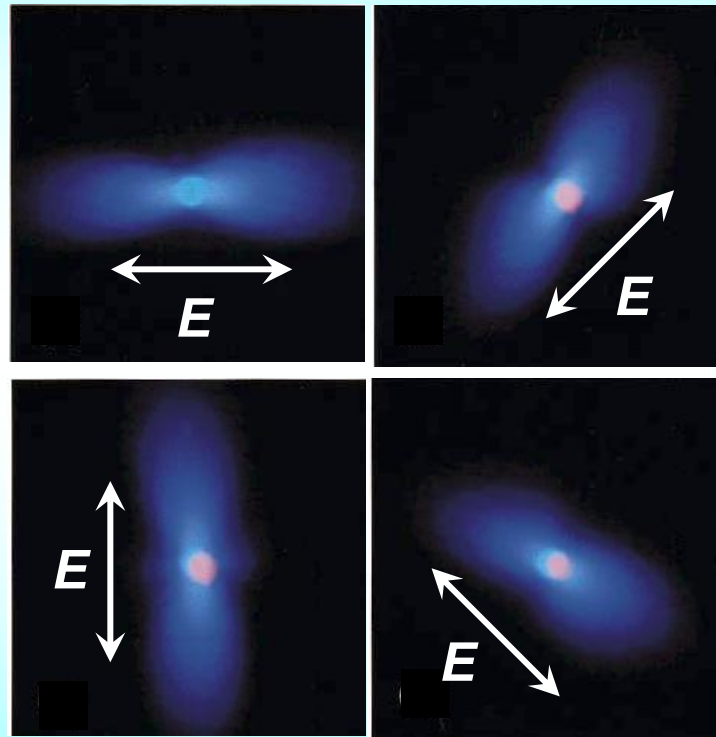

100  $\mu\text{m}$

**Polarization-dependent light scattering**

*Phys. Rev. Lett.*, 82(1999)2199.

# Memorized polarization-dependent light scattering in doped glasses and crystals

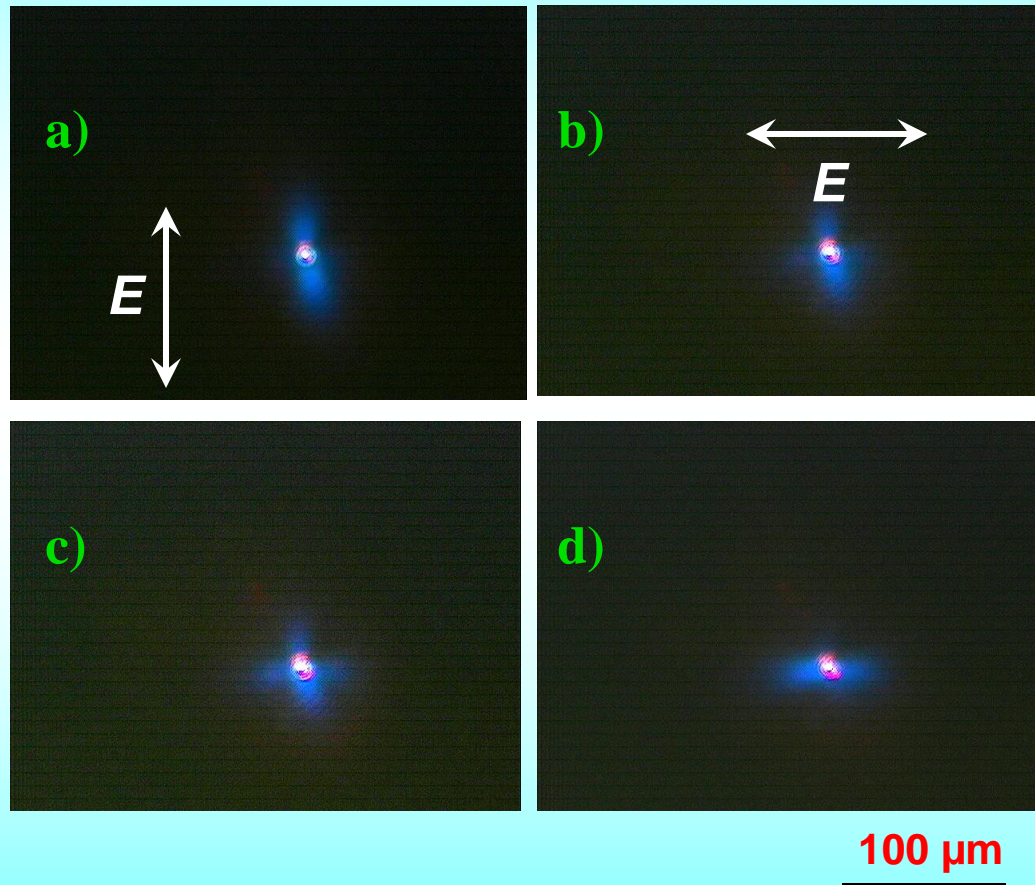

*Appl. Phys. Lett.*, 77(2000)1940.

# Single femtosecond laser beam-induced nanograting

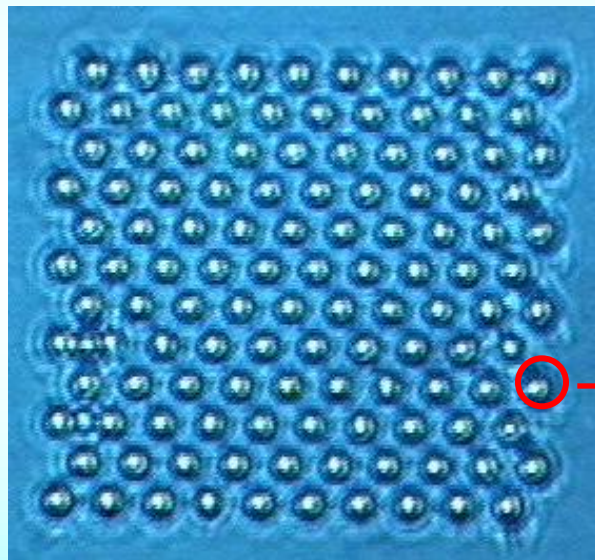

Optical  
microphotograph

100× (0.95)  
120fs  
200kHz  
200mW  
1s

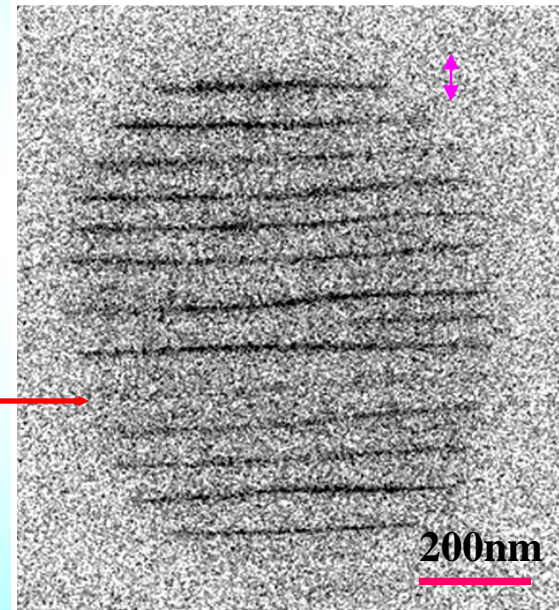

BEI image of SEM

*Phys. Rev. Lett.*, 91(2003)247405.

# Polarization-dependent femtosecond laser-induced nano-structure

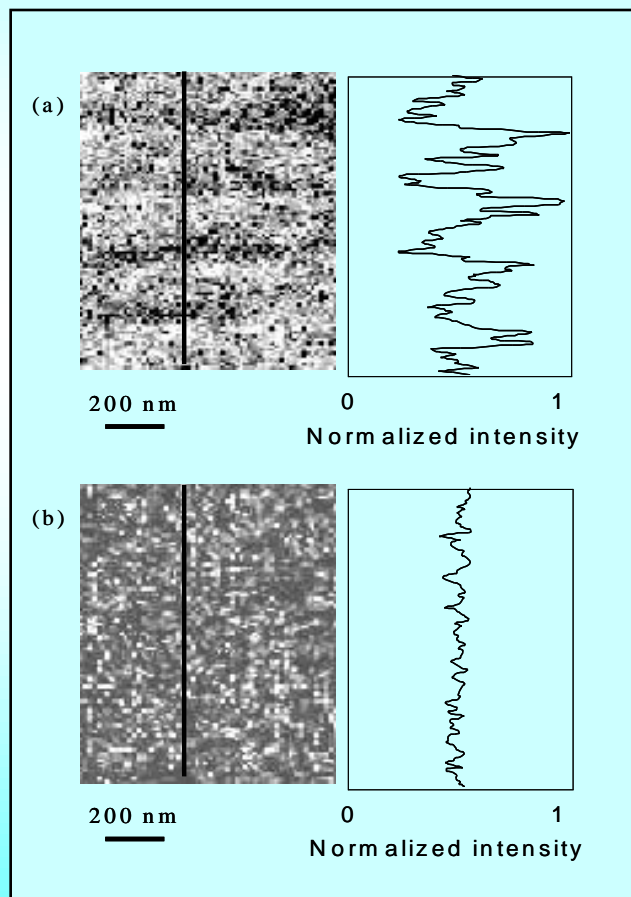

O and Si concentration AES mapping

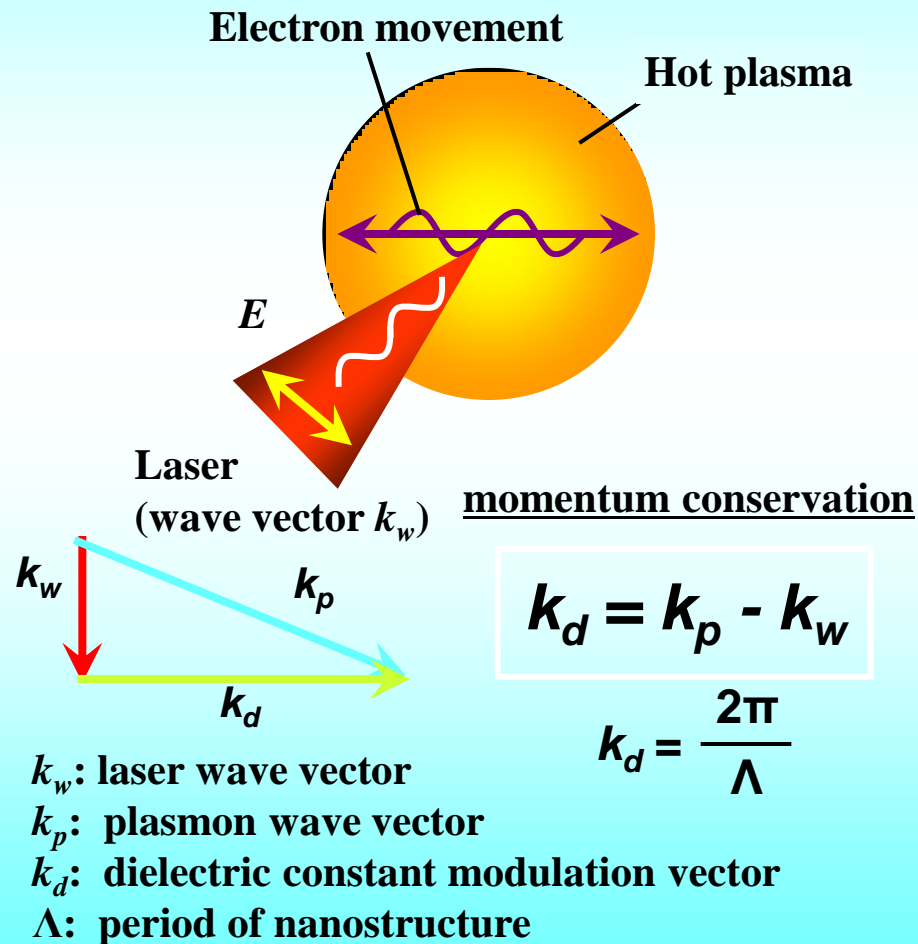

Mechanism of the nanograting

# Femtosecond laser induced long lasting phosphorescence

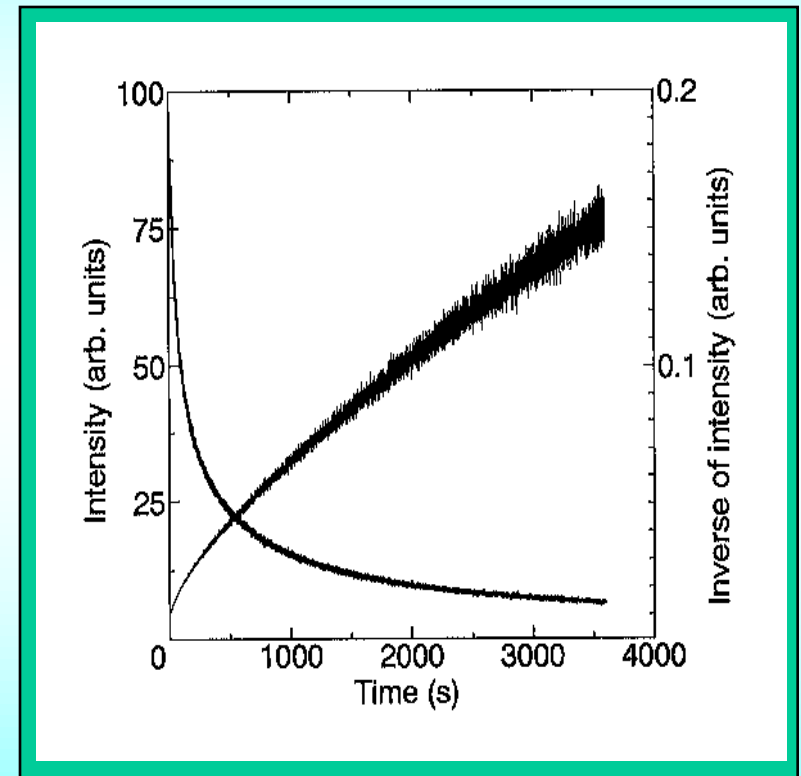
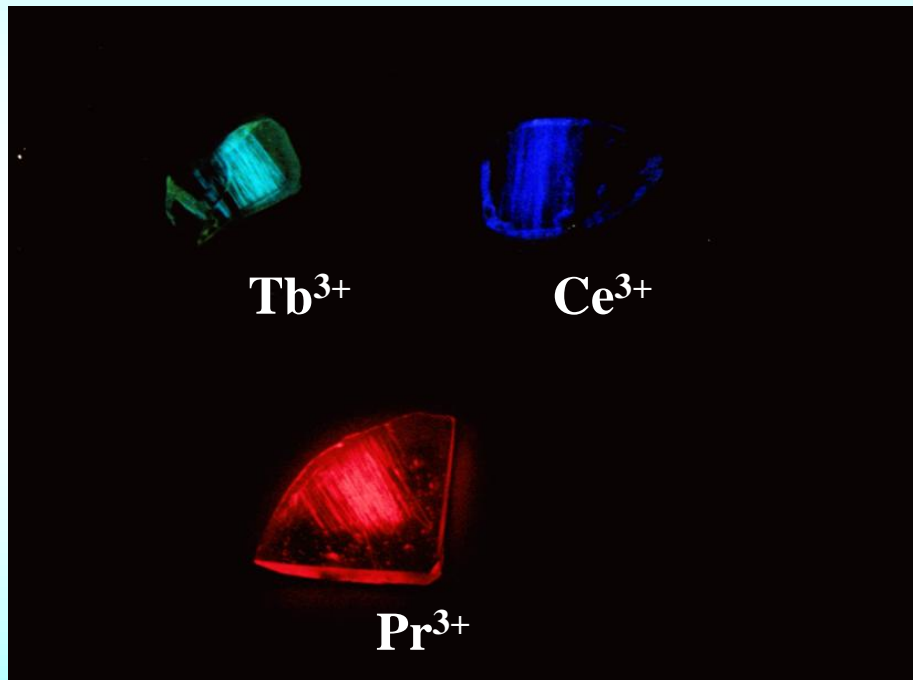

Decay curve of the phosphorescence at 543nm in the femtosecond laser irradiated  $Tb^{3+}$  -doped fluorozirconate glass

*Appl. Phys. Lett.*, 73(1998)1763.

# Fs laser-induced nano-void array

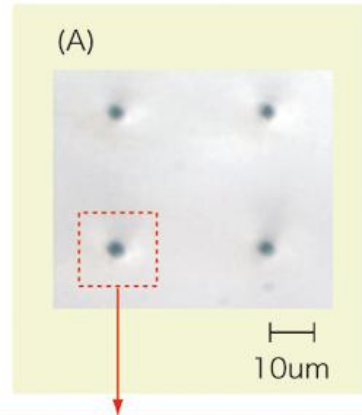
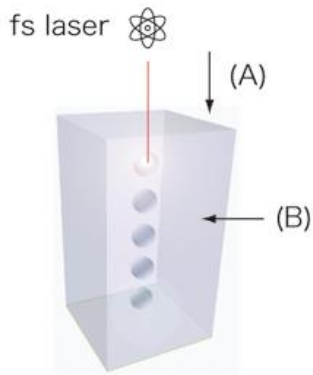

Condition :

Repetition rate : 1 kHz

Pulse number : 250 pulses

Pulse energy : 10  $\mu\text{J}$

Objective lens : 100 $\times$  (NA = 0.9)

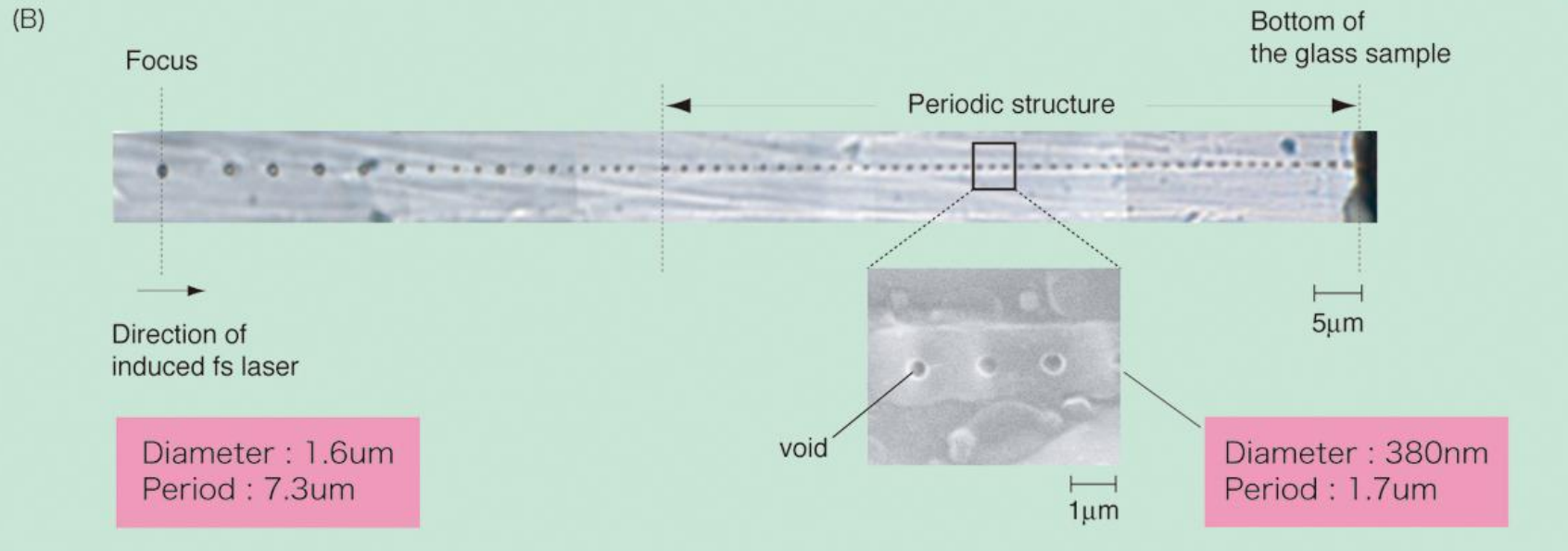

*Nano Lett.*, 5(2005)1591.

Non-paraxial nonlinear Schrodinger equation to exactly describe the pulse propagation:

$$\frac{\partial^2 E}{\partial z^2} + i2k \frac{\partial E}{\partial z} + \nabla_{\perp}^2 E = kk'' \frac{\partial^2 E}{\partial \xi^2} - \underbrace{ik\sigma(1+i\omega\tau_c)\rho E - ik\beta^{(K)}|E|^{2K-2}E - 2kk_0 n_2 |E|^2 E}_{\text{Nonlinear effects}} \quad (1)$$

### Electron density

$$\frac{\partial \rho}{\partial \xi} = \frac{1}{n^2} \frac{\sigma}{E_s} \rho |E|^2 + \frac{\beta^{(K)} |E|^{2K}}{K \hbar \omega} - \frac{\rho}{\tau_r}$$

Analysis of interface spherical aberration by P. Török et al (electromagnetic diffraction th

$$I_0^{(e)} = \int_0^{\phi_{\max}} (\cos \phi_1)^{1/2} (\sin \phi_1) \exp \left[ ik_0 \underbrace{\psi(\phi_1, \phi_2, -d)}_{\text{aberration function}} \right] \times (\tau_s + \tau_p \cos \phi_2) J_0(k_1 r_p \sin \phi_p \sin \phi_1) \times \exp(i k_2 r_p \cos \phi_p \cos \phi_2) d\phi_1 \quad (3)$$

# Fs laser-induced nano-void array

## Self-aligned voids structure

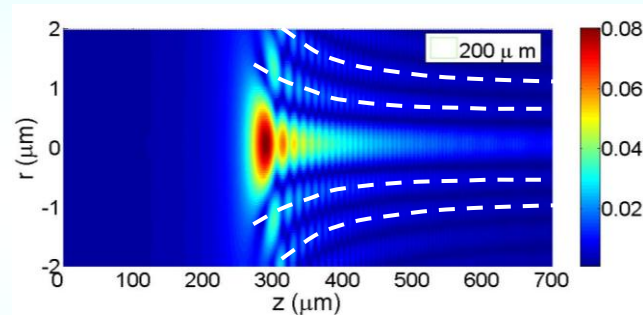

*Appl. Phys. Lett.*,  
**92(2008)92904.**

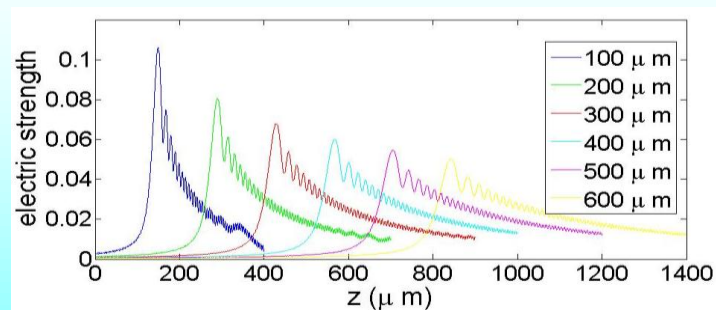

electromagnetic  
diffraction  
theory

**On-axis electric strength distribution along the direction of the laser propagation (spherical aberration )**



# Coordination state change due to fs laser induced migration of ions

*Appl. Phys. Lett.*, 92(2008)121113.

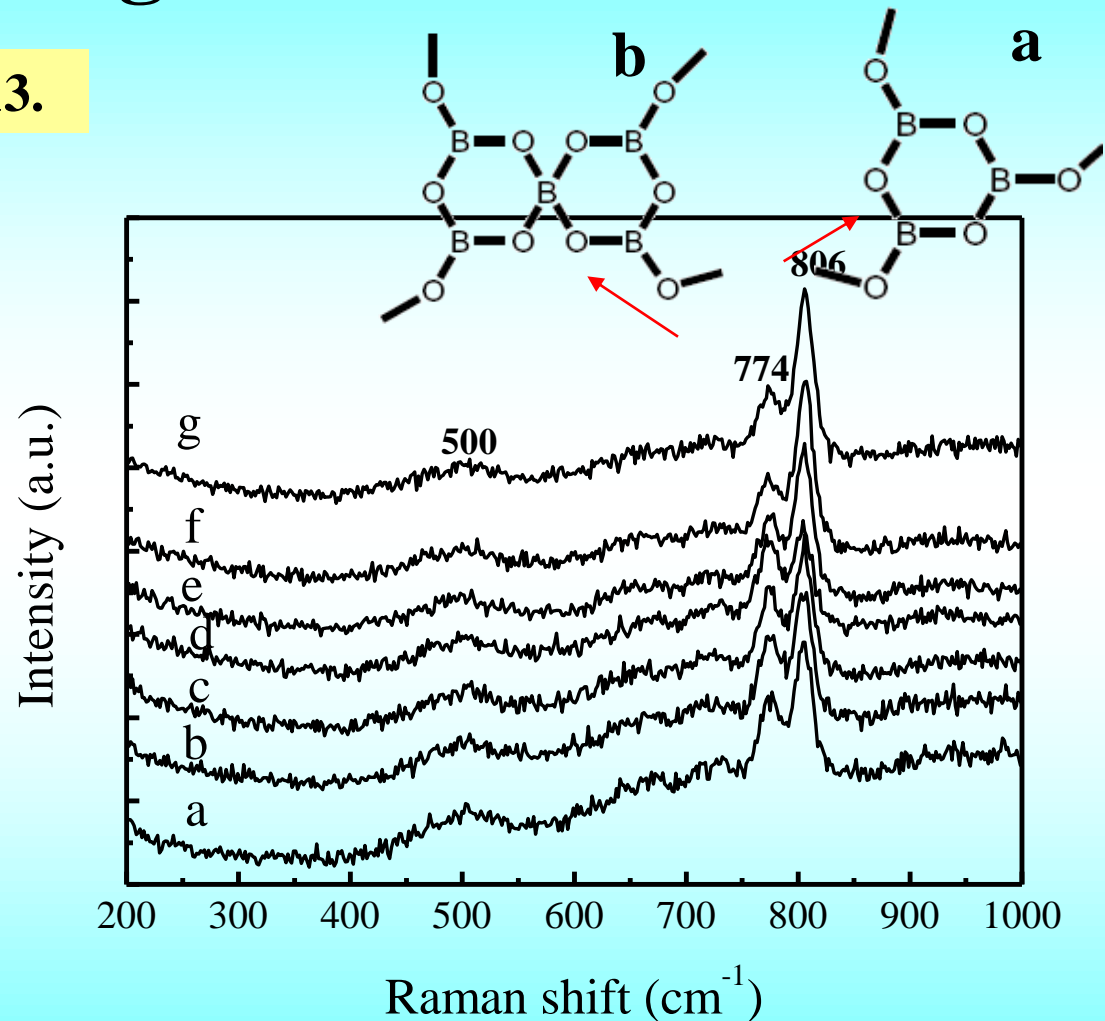
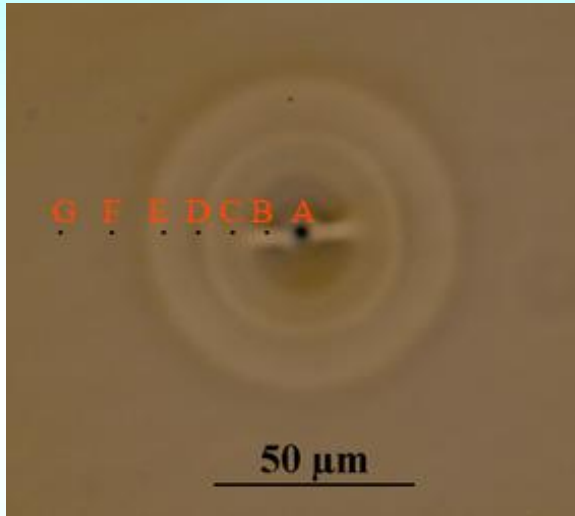

Different positions A–G inside or outside the laser modified zone shown in microscope images and their corresponding micro-Raman spectra a–g.

# Coordination state change due to fs laser induced migration of ions

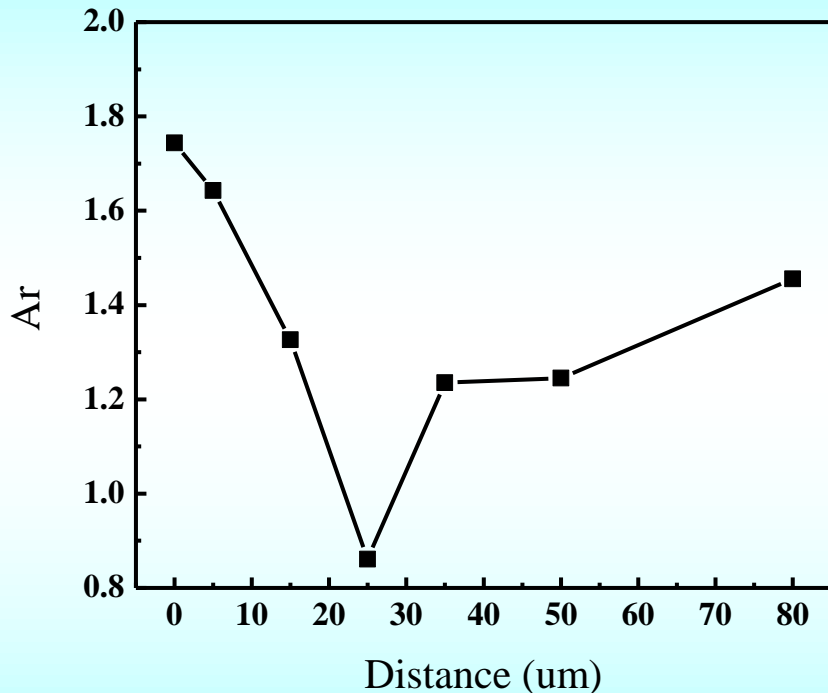

The relative integrated intensity  $A_r$  vs the distance from the central laser focal volume.

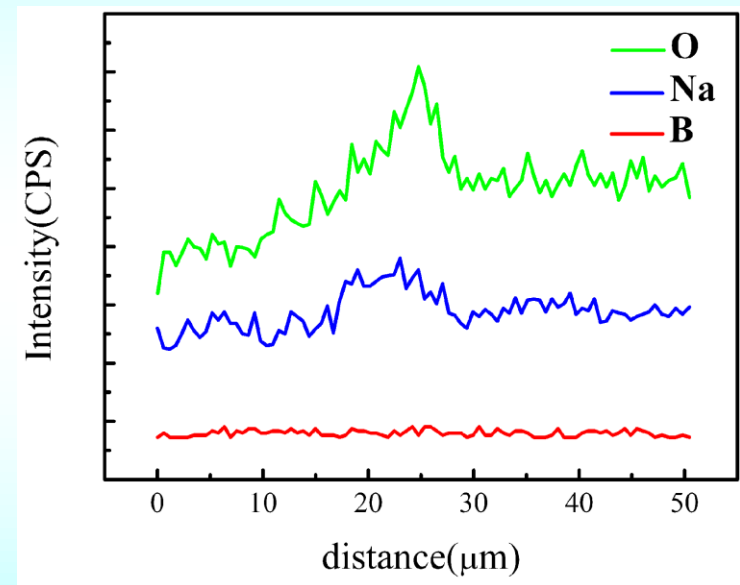

EDX line scanning spectra showing element distribution from the laser focal point to the edge of the laser modified zone.

# Fs laser induced migration of ions

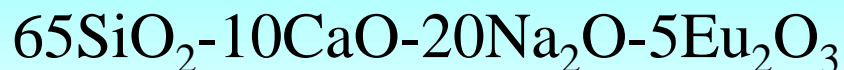

*Opt. Lett.*, 92(2009)121113.

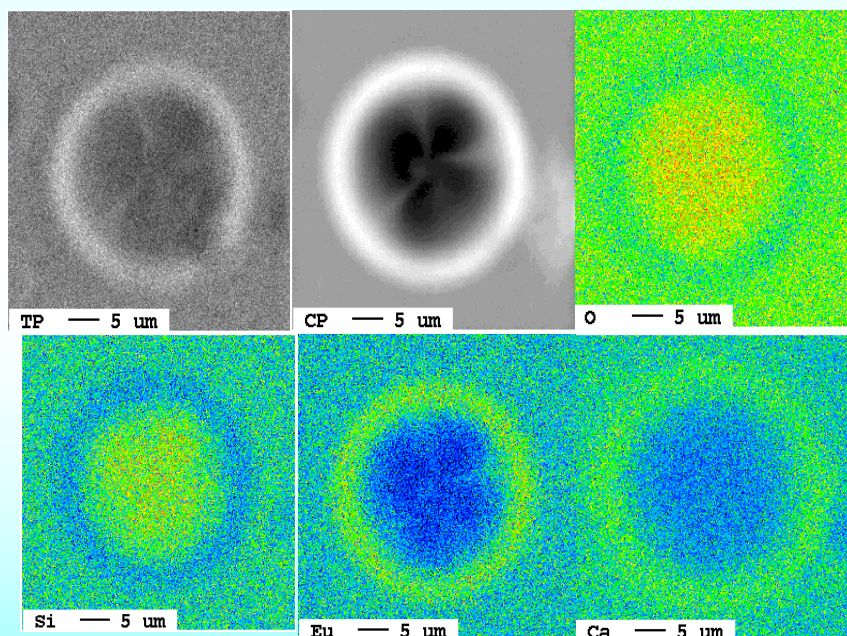

EDX line scanning spectra showing element distribution from the laser focal point to the edge of the laser modified zone.

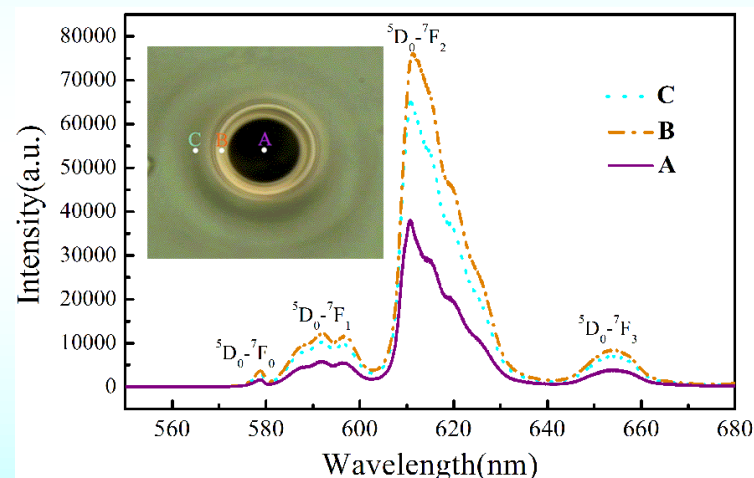

Confocal fluorescence spectra from different positions (A-C) of a laser modified zone.

# AFM observation of micro-grating in glasses by coherent field of ultrashort pulsed lasers

$(\omega+\omega)$

*Appl. Phys. Lett.*, 77(2000)3887.

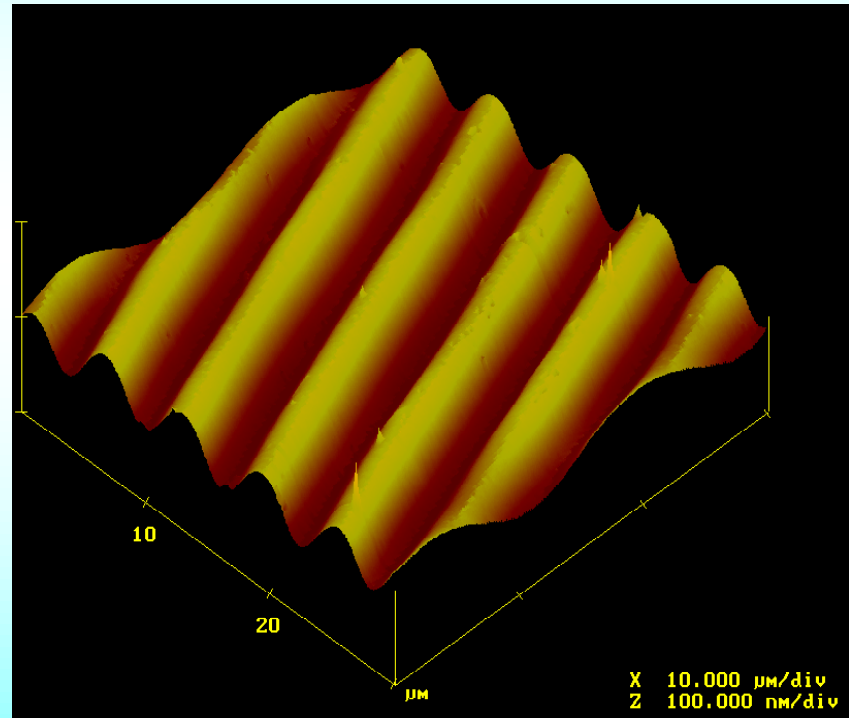
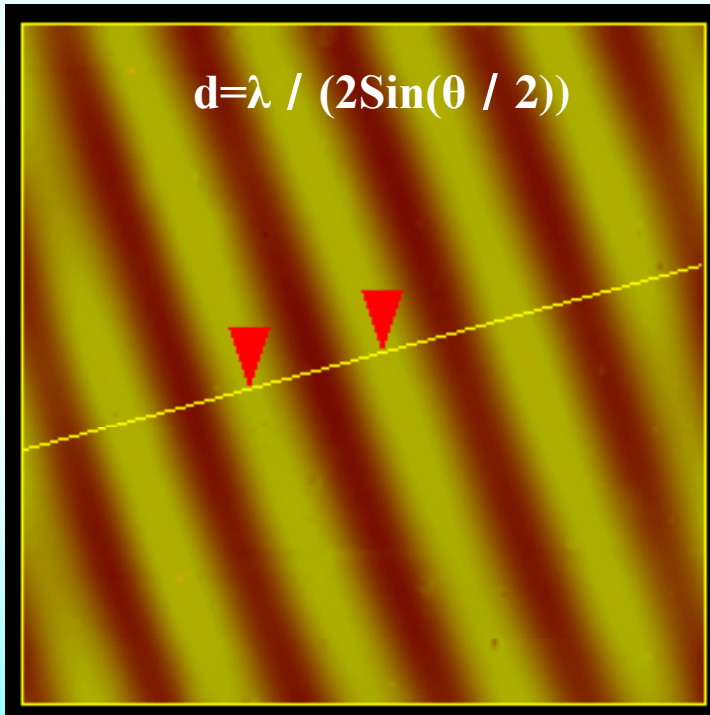

$\eta > 90\%$

# Observation of micro-grating in azobenzene polyimide by coherent field of ultrashort pulsed lasers

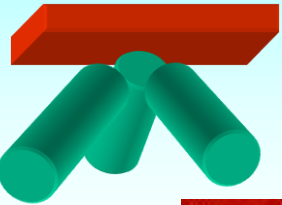

$(\omega+\omega+\omega)$

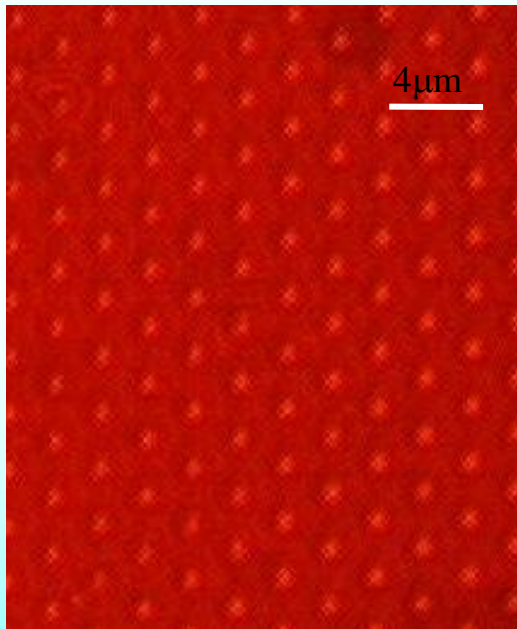

$\theta = 7^\circ$   
 $d = 4 \mu\text{m}$

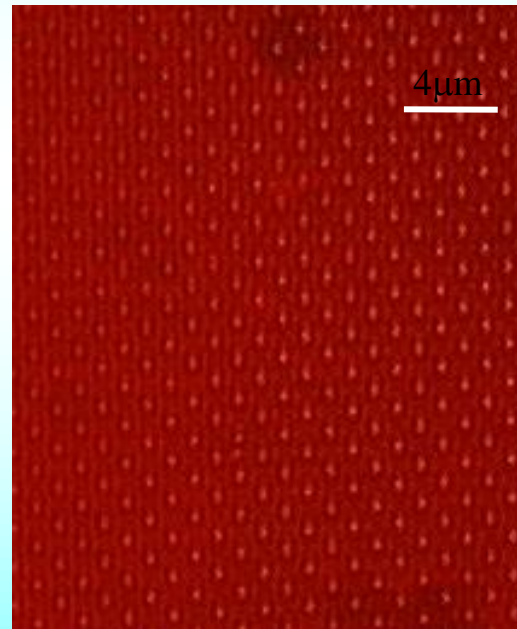

$\theta = 15^\circ$   
 $d = 2 \mu\text{m}$

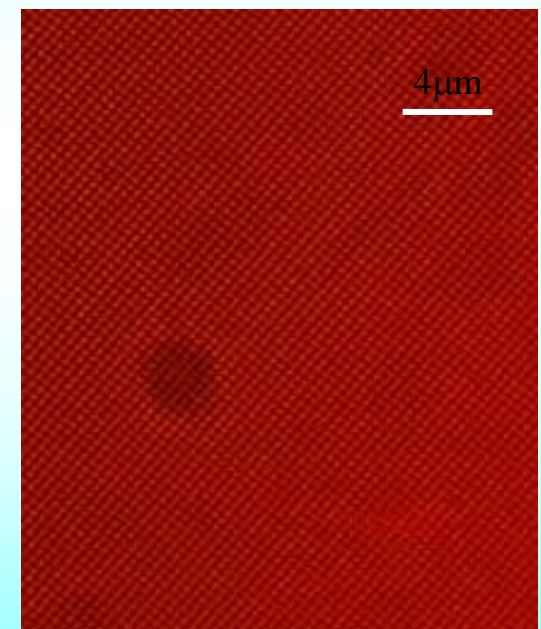

$\theta = 45^\circ$   
 $d = 0.7 \mu\text{m}$

# All-optical poling ( $\omega+2\omega$ )

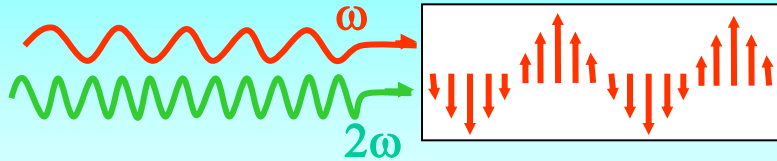

Photoinduced noncentrosymmetry  $\chi^{(2)}$

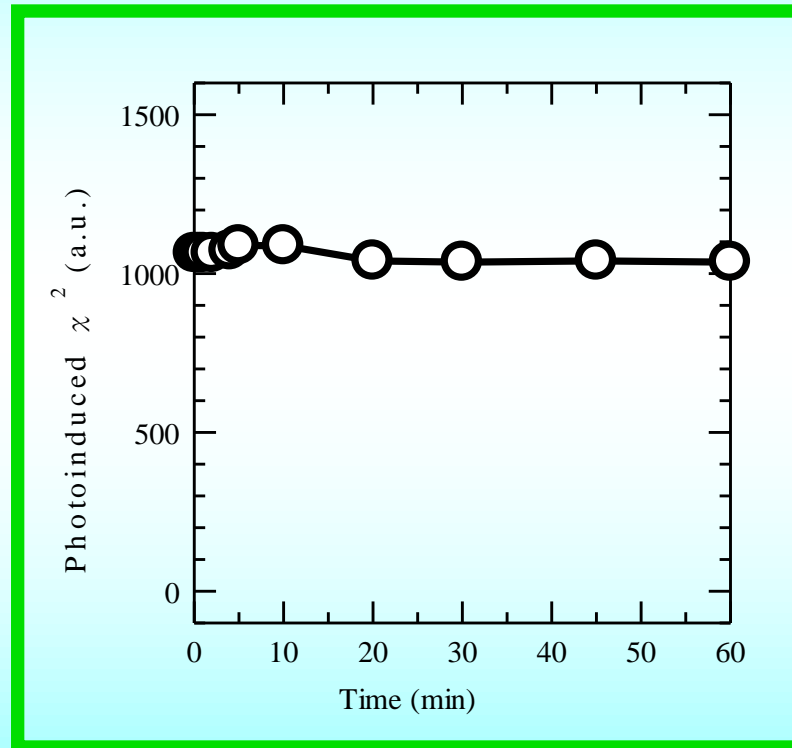

*Opt. Lett.,*  
26(2001)914.

**Non-linear coherent field induced large and stable second harmonic generation in chalcogenide glasses.**

# Micro structures looks like bear-paw induced by fs laser beam

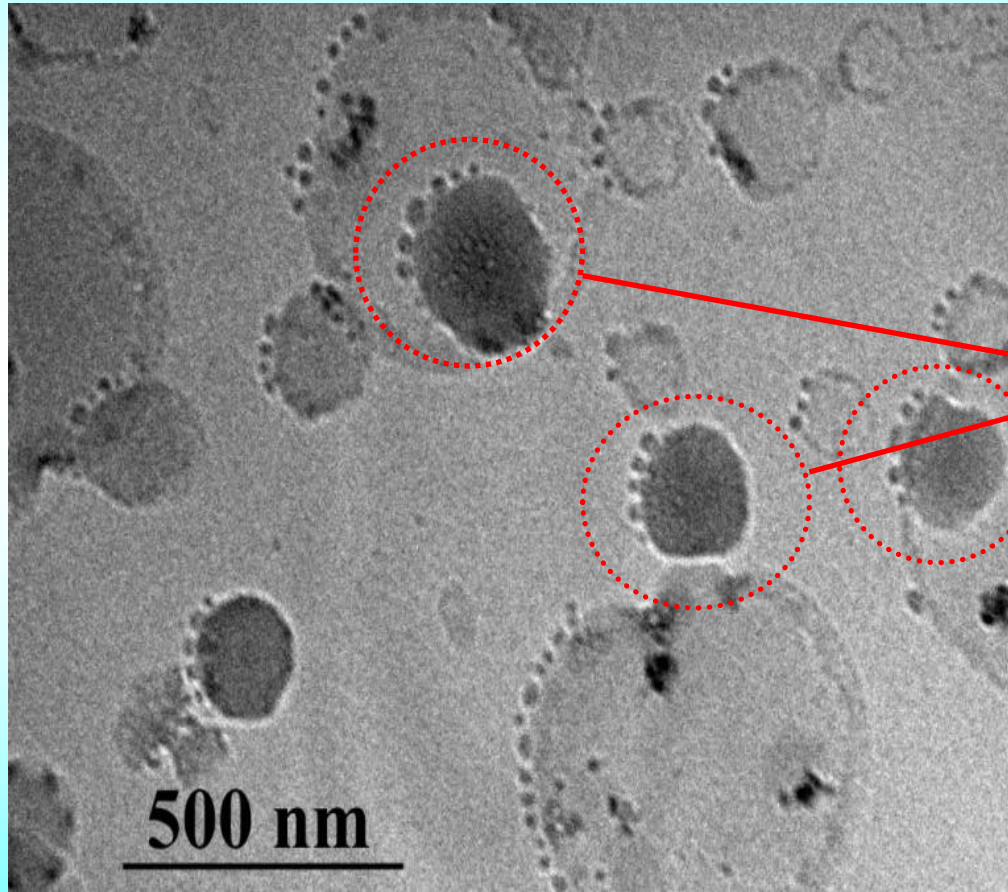

Famous Chinese Dish  
Bear-paw  
( 熊掌 )

# **Conclusion**

**We have observed many interesting phenomena due to the interaction between femtosecond laser and transparent materials e.g. glasses.**

**We have demonstrated 3D rewritable optical memory, fabrication of 3D optical circuits, 3D micro-hole drilling, and 3D precipitation of functional crystals.**

**Our findings will pave the way for the fabrication of functional micro-optical elements and integrated optical circuits.**





Xiaosheng Liang

这是一片神奇的土地

This is a mysterious land

**You will harvest (in Autumn) if you sow seeds (in Spring)**

**Ask and it will be given to you; seek and you will find;  
knock and the door will be opened to you**

# Acknowledgements

## Research Colleagues

*Profs. K. Hirao, Drs. K. Miura, Y. Shimotsuma, S. Kanehira*

**(Kyoto University, Japan)**

*Profs. C. Zhu, My students and PostDoc researchers*

**(Zhejiang University and SIOM, CAS)**

*Prof. P. Kazansky* **(Southampton Univ., UK)**

*Dr. N. Jiang* **(Arizona State Univ., UK)**



**Thanks !**

# Compact femtosecond laser



# Ultrashort-pulse laser machining of dielectric materials

M. D. Perry et al., J. Appl. Phys., 85(1999)6803.

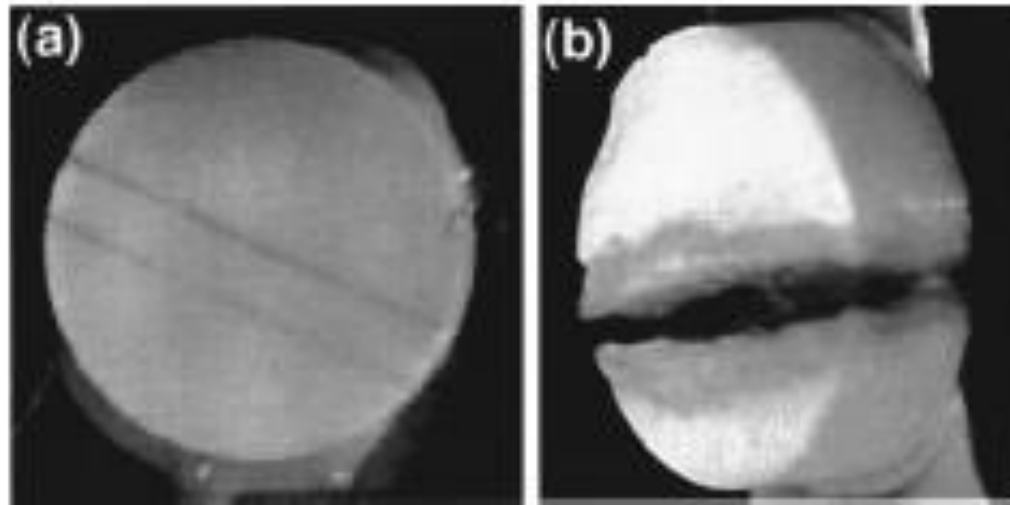
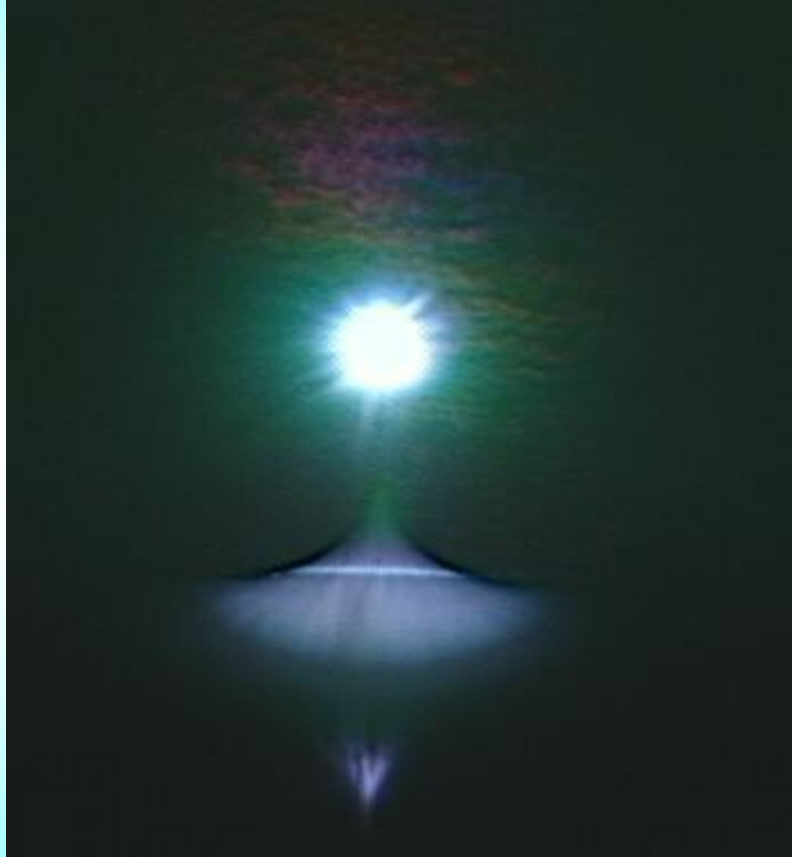

FIG. 10. Cuts in explosive pellet (LX-16-95% PETN) by a Ti:sapphire laser operating at 120 fs (a) and 600 ps (b). Thermal deposition in the long-pulse case caused the pellet to ignite and burn (b).



# Space-selective emission in rare-earth-doped glasses excited by an 800nm femtosecond laser



Front view

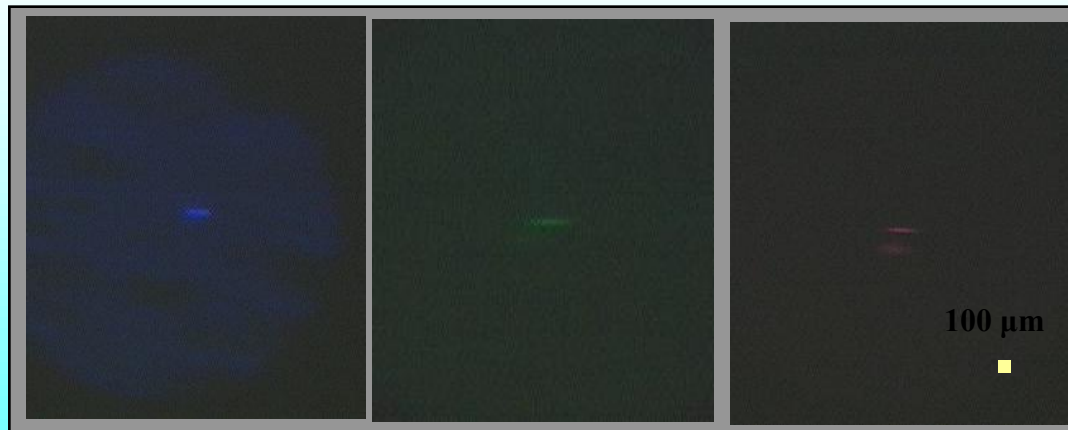

Side view

# Emission spectra of rare-earth doped glass

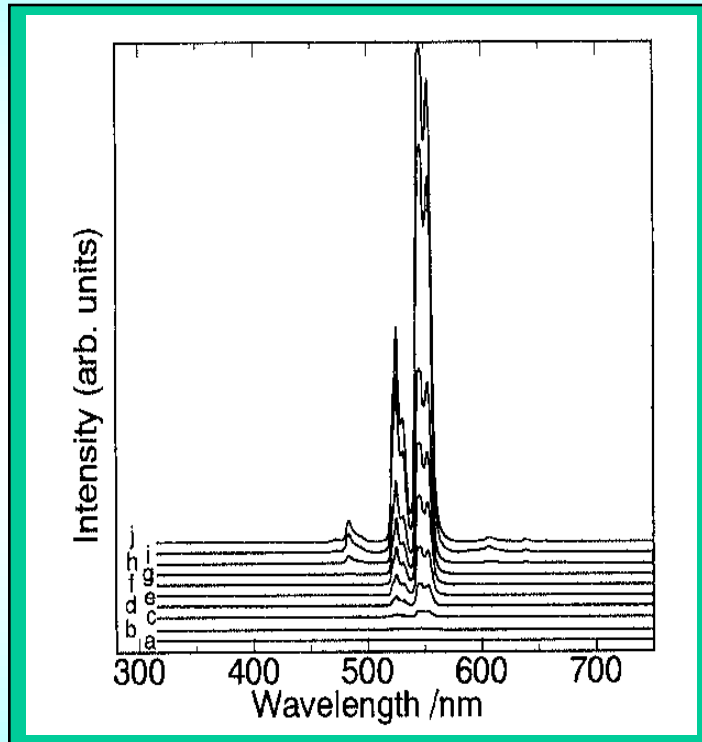

Excitation power-dependence of the photoluminescence spectra of a Tb<sup>3+</sup>-doped ZBLAN glass

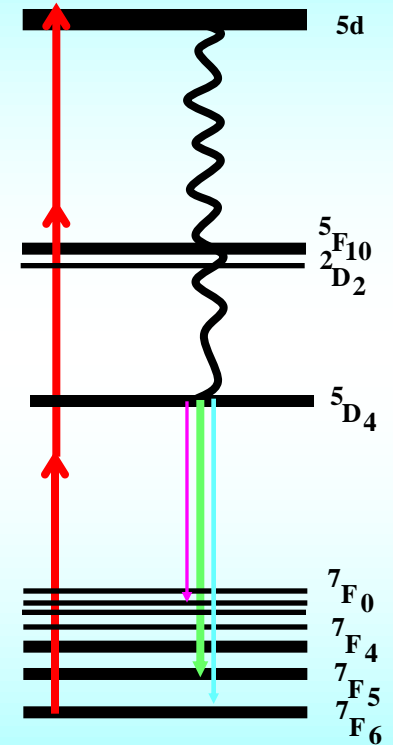

Energy levels of Tb<sup>3+</sup>



# Precise surface processing

B. N. Chichkov et al., Appl. Phys. A63 (1996) 109.

$$L_D = (D\tau)^{1/2}$$

$$D = k_T / \rho C_p$$

(1ps, 10nm)

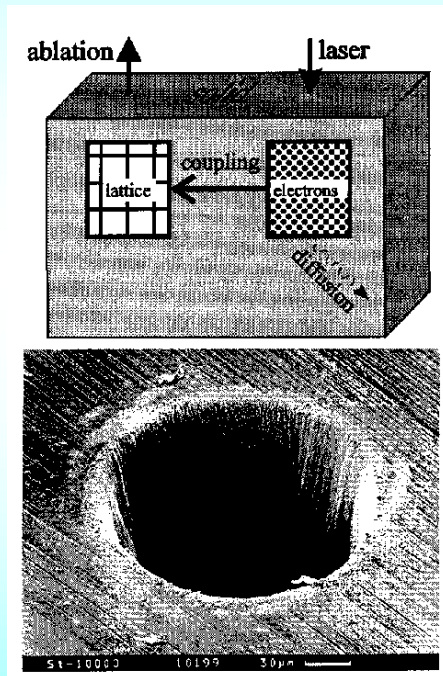

a hole drilled in steel  
with 200fs laser pulses  
at 780nm

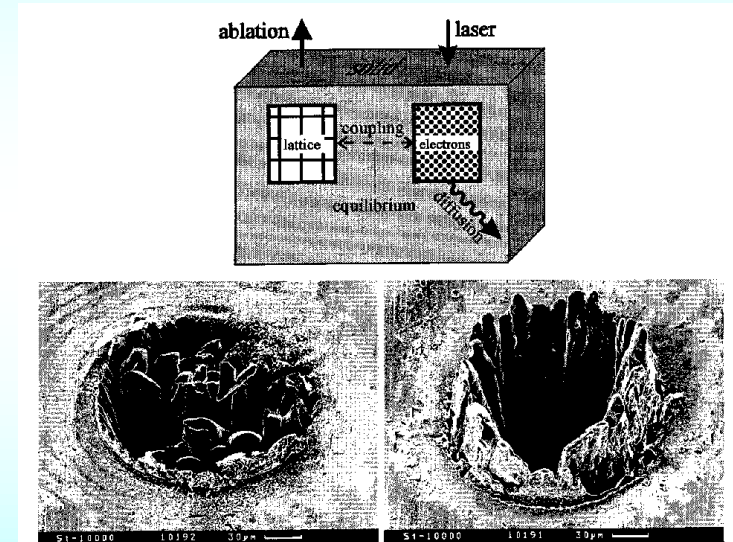

holes drilled in steel with  
80ps(left)and 3.3ns(right)  
laser pulses at 780nm

$$\gamma = \frac{\omega}{e} \left[ \frac{m c n \varepsilon_0 E_g}{I} \right]^{1/2}$$

$\gamma < 1.5$   
tunneling

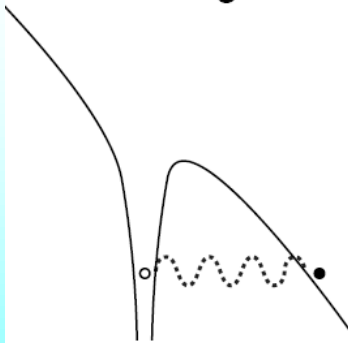

$\gamma \sim 1.5$   
intermediate

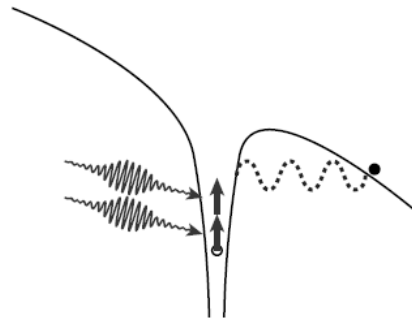

$\gamma > 1.5$   
MPI

